



6.0 InterScan™ Web Security Virtual Appliance

Administrator's Guide

Antivirus and Content Security at the Web Gateway



Trend Micro Incorporated reserves the right to make changes to this document and to the products described herein without notice. Before installing and using the software, please review the readme files, release notes and the latest version of the Installation Guide, which are available from Trend Micro's Web site at:

<http://www.trendmicro.com/download/documentation/>

Trend Micro, the Trend Micro t-ball logo, InterScan, TrendLabs, Trend Micro Control Manager, and Trend Micro Damage Cleanup Services are trademarks or registered trademarks of Trend Micro Incorporated. All other product or company names may be trademarks or registered trademarks of their owners.

Copyright© 2013 Trend Micro Incorporated. All rights reserved. No part of this publication may be reproduced, photocopied, stored in a retrieval system, or transmitted without the express prior written consent of Trend Micro Incorporated.

Release Date: June 2013

Protected by U.S. Patent No. 5,951,698

The Administrator's Guide for Trend Micro is intended to provide in-depth information about the main features of the software. You should read through it prior to installing or using the software.

For technical support, please refer to the Technical Support and Troubleshooting chapter for information and contact details. Detailed information about how to use specific features within the software are available in the Online Help file and online Knowledge Base at Trend Micro's Web site.

Trend Micro is always seeking to improve its documentation. If you have questions, comments, or suggestions about this or any Trend Micro documents, please contact us at docs@trendmicro.com. Your feedback is always welcome. Please evaluate this documentation on the following site:

<http://www.trendmicro.com/download/documentation/rating.asp>

Contents

Preface

IWSVA Documentation	xxii
Audience	xxiii
Document Conventions	xxiii
About Trend Micro	xxiv

Chapter 1: Introducing Trend Micro™ InterScan™ Web Security Virtual Appliance

Main Features	1-2
Application Control	1-2
Traffic Monitoring and Reporting	1-2
HTTP Inspection	1-2
Password Override Action for Blocked URL Filtering Categories	1-2
Time Limit Action for URL Filtering	1-3
Time Quota Extension for URL Filtering Time Limit Action	1-3
Data Loss Prevention	1-3
Data Identifier Types	1-4
Expressions	1-4
Predefined Expressions	1-4
Keyword Lists	1-5
Predefined Keyword Lists	1-5
Data Loss Prevention Templates	1-5
Data Loss Prevention Policies	1-6
Advanced Threat Protection	1-6
HTTPS Decryption	1-6
Web Reputation	1-6
High Availability	1-7
FTP Scanning	1-7
URL Filtering	1-8
Content Caching	1-8
IP Address, Host Name and LDAP-based Client Identification	1-8

Hyper-V Installation Support	1-8
Notifications	1-9
Real-time Statistics and Alerts	1-9
Logs and Reports	1-9
Syslog Support	1-10
Integration with Cisco WCCP	1-10
Reverse Proxy Support	1-11
Support for Multiple Trend Micro™ InterScan™ Web Security Virtual Appliance Installations	1-11
Command Line Interface	1-11
What's New?	1-12
System Specifications	1-12
Web-based Browser Requirements	1-12
Hardware Requirements	1-13
Compatible Directory Servers for End-User Authentication	1-13
Integration with ICAP 1.0-compliant Caching Devices	1-14
X-Authenticated ICAP Headers Support	1-14
System Status	1-14
Enabling Threshold Alert Settings	1-15
Concurrent Connections Display	1-15
Interface Status	1-16
Hardware Status	1-16
SNMP Queries and Traps	1-17
CPU Usage Display	1-18
Physical Memory Usage Display	1-19
Hard Drive Display	1-19
Accessing Additional Web Threat Information	1-19
Dashboard	1-20
Web Traffic Security Risk Overview	1-22
Smart Search Support	1-24

Chapter 2: Deployment Wizard

Overview of the Deployment Wizard	2-2
Mode Selection	2-2

Transparent Bridge Mode	2-3
Transparent Bridge Mode - High Availability	2-4
About Cluster IP Addresses	2-5
About Weighted Priority Election	2-6
Create a New Cluster	2-6
Join an Existing Cluster	2-8
Forward Proxy Mode	2-9
Reverse Proxy Mode	2-10
ICAP Mode	2-11
Deploying IWSVA in ICAP Mode in the Deployment Wizard ..	2-12
Simple Transparency Mode	2-13
Web Cache Coordination Protocol (WCCP) Mode	2-14
Mode-specific Settings	2-15
Proxy Settings	2-16
Forward Proxy Mode	2-16
Reverse Proxy Settings	2-18
ICAP Settings	2-19
Simple Transparency Settings	2-21
WCCP Settings	2-22
Network Interface	2-26
Host Information	2-26
Interface Status	2-27
Data Interface	2-29
Separate Management Interface	2-31
Miscellaneous Settings (IPv4 and IPv6)	2-32
Static Routes	2-33
Product Activation	2-34
About Licenses	2-35
Third-party Licensing Agreements	2-35
Registering Online	2-36
About Activation Codes	2-37
System Time Settings	2-38
Results	2-39
Deployment Status	2-39
Post Deployment	2-39

LAN Bypass Function	2-40
Enabling the LAN Bypass Function	2-41
Setting Up IWSVA ICAP	2-43
Setting up an ICAP 1.0-compliant Cache Server	2-43
Configuring Virus-scanning Server Clusters	2-49
Deleting a Cluster Configuration or Entry	2-50
Flushing Existing Cached Content from the Appliance	2-50
Verifying that InterScan Web Security Virtual Appliance is Listening for ICAP Requests	2-51
Understanding the Differences between Request Mode and Response Mode	2-53
Triggering a Request Mode Action	2-53
Triggering a Response Mode Action	2-54

Chapter 3: High Availability and Cluster Management for Transparent Bridge Mode

High Availability Overview	3-2
About Active/Passive Pairs	3-3
The HA Agent Handles Status Changes	3-4
Failover vs. Switchover	3-4
HA Agent and Interfaces	3-4
About the Deployment Wizard	3-4
Creating a Cluster	3-5
Joining a Cluster	3-5
About the Application Health Monitor	3-5
Link Loss Detection	3-6
About Central Management	3-6
Centrally Managed and Non-centrally Managed Features	3-7
About Cluster Management	3-10
Cluster Configuration	3-10
Node Configuration	3-11
Cluster Logs and Notifications	3-12
Accessing the Cluster	3-12
Cluster Management Web Console Page	3-15

Chapter 4: Updates

Product Maintenance	4-2
Renewing Your Maintenance Agreement	4-2
About ActiveUpdate	4-3
Updating From the IWSVA Web Console	4-3
Proxy Settings for Updates	4-4
Updatable Program Components	4-5
Virus Pattern File	4-5
How it Works	4-6
Page Analysis Pattern	4-7
Spyware/Grayware Pattern File	4-7
IntelliTrap Pattern and IntelliTrap Exception Pattern Files	4-7
Scan Engine	4-8
About Scan Engine Updates	4-9
Web Reputation Database	4-9
Incremental Updates of the Pattern Files and Engines	4-10
Component Version Information	4-10
Manual Updates	4-10
Forced Manual Updates	4-11
Scheduled Updates	4-12
Maintaining Updates	4-13
Update Notifications	4-13
Rolling Back an Update	4-13
Deleting Old Pattern Files	4-13
Controlled Virus Pattern Releases	4-14

Chapter 5: Application Control

Application Control Overview	5-2
Application Control Policy List	5-2
Add Policies: Select Accounts	5-4
Adding an Application Control Policy	5-5
Add or Edit Policies: Specify Rules for Application Control Policies	5-5

Specifying Application Control Policy Rules	5-6
Application Control Settings	5-8
Traffic Monitoring Overview	5-9
Notification for Denying HTTP/HTTPS Access with Application Control	5-10

Chapter 6: HTTP Configuration

Enabling the HTTP/HTTPS Traffic Flow	6-2
Specifying a Proxy Configuration and Related Settings	6-2
Proxy Configurations	6-4
No Upstream Proxy (Stand-alone Mode)	6-4
Upstream Proxy (Dependent Mode)	6-5
Transparent Proxy	6-7
Reverse Proxy	6-9
Proxy-related Settings	6-10
HTTP Listening Port	6-10
Anonymous FTP Logon Over HTTP Email Address	6-11
Network Configuration and Load Handling	6-11
Configuring Internet Access Control Settings	6-12
Identifying Clients and Servers	6-13
Client IP	6-13
Approved Server IP List	6-14
Destination Port Restrictions	6-15
HTTPS Ports	6-16

Chapter 7: Policies and User Identification Method

How Policies Work	7-2
Default Global and Guest Policies	7-4
About the Guest Policy	7-5
Enabling the Guest Account	7-5
Policy Queries	7-6
Deploying Policies	7-6
Configuring the User Identification Method	7-6

IP Address	7-8
Client Registration Utility	7-9
User/Group Name Authentication	7-10
LDAP Authentication Method	7-10
LDAP Communication Flows	7-11
LDAP Authentication in Transparent Mode	7-12
Configuring LDAP Settings	7-13
Cross Domain Active Directory Object Queries	7-17
Configuring the Scope of a Policy	7-17
Configuring Policies Using IP Addresses	7-18
Configuring Policies Using LDAP	7-19
Login Accounts	7-20
Adding a Login Account	7-20
About Access Rights	7-21
Changing a Login Account	7-21

Chapter 8: Configuring HTTP Scanning

Enabling Advanced Threat Protection and Applets and ActiveX Security	8-2
Advanced Threat Protection Performance Considerations	8-2
HTTP Inspection Overview	8-3
HTTP Inspection Policies	8-4
HTTP Inspection: Select Accounts	8-5
HTTP Inspection: Specify Rules	8-6
HTTP Inspection: Specify Exception Lists	8-8
HTTP Inspection Filters	8-8
Default HTTP Inspection Filters	8-8
Add an HTTP Inspection Filter	8-13
Editing an HTTP Inspection Filter	8-22
Importing an HTTP Inspection Filter	8-23
Exporting an HTTP Inspection Filter	8-25
Data Loss Prevention	8-25
Policies	8-26
Templates	8-28
iDLP	8-28

HTTPS Security	8-28
Dangers of Unchecked HTTPS Content	8-29
SSL Handshake Overview	8-30
HTTPS Decryption and Process Flow in IWSVA	8-31
Configuring HTTPS Decryption Policies	8-32
HTTPS Accelerator Card Support	8-32
Domain Tunneling	8-33
Tunneled Domains	8-33
Exceptions to the Tunneled Domains	8-34
Failed HTTPS Accesses	8-34
Creating a New HTTPS Decryption Policy	8-34
HTTPS Decryption Settings	8-36
Server Certificate Validation	8-36
Client Certificate Handling	8-37
Creating and Modifying Advanced Threat Protection Policies	8-40
Specifying Web Reputation Rules	8-42
Anti-phishing, Anti-pharming, and C&C Callback	
Attempt Detection	8-43
Custom Defense Settings	8-43
Enable Custom Defense	8-44
Settings for Virtual Analyzer C&C List	8-44
Actions	8-44
Web Reputation Settings	8-44
Enabling and Disabling Web Reputation	8-44
Managing Web Reputation Results	8-45
Clearing the WRS/URL Cache	8-46
Using the Content Cache	8-47
Enabling/Disabling the Content Cache	8-47
Clearing the Content Cache	8-48
Managing the Content Cache	8-49
Content Cache Real-time Statistics	8-50
Content Cache Exception List	8-51
HTTP Virus Scanning Rules	8-52
Advanced Threat Scan	8-52
Specifying File Types to Block	8-52
Specifying File Types to Scan	8-53
Priority for Virus/Malware Scan Configuration	8-57

Configuring Compressed File Scanning Limits	8-57
Handling Large Files	8-58
Quarantined File Handling	8-64
Spyware and Grayware Scanning Rules	8-64
X-Forwarded-For HTTP Headers	8-65
Configuring X-Forwarded-For HTTP Headers	8-67
Specifying Bot and C&C Contact Detection Rules	8-68
Specifying the Exceptions List	8-68
Creating Exception Lists	8-69
Setting the Scan Action for Viruses	8-72
Scan Actions	8-72
Scan Events	8-73
Adding Notes to Your Policy	8-74
Java Applet and ActiveX Security	8-75
How Applets and ActiveX Security Works	8-76
Step 1. Filtering Applets & ActiveX at the Server	8-76
Step 2. Instrumenting Applets	8-77
Step 3. Optionally Re-signing Instrumented Applets	8-77
Step 4. Monitoring Instrumented Applet Behavior	8-78
Enabling Applet/ActiveX Security	8-78
Adding and Modifying Applet/ActiveX Scanning Policies	8-79
Configuring Java Applet Security Rules	8-79
Signature Status	8-80
Certificate Status	8-80
Instrumentation and Re-signing	8-80
Applet Instrumentation Settings	8-81
Configuring Exceptions	8-81
Configuring ActiveX Security Rules	8-85
Applying Applet and ActiveX Policy Exceptions	8-85
Applet and ActiveX Settings	8-85
Java Applet Signature Validation	8-86
Adding Certificates for Applet Signature Verification	8-86
Certificate Expiration	8-87
Untrusted Signature Status	8-87
Revocation Status	8-87
Applet Re-signing	8-87

ActiveX Signature Validation	8-88
Client-side Applet Security Notifications	8-89
Managing Digital Certificates	8-90

Chapter 9: Access Quotas and URL Access Control

Introduction to Access Quota Policies	9-2
Managing Access Quota Policies	9-2
Overview of URL Access Control	9-4
Specifying URL Access Control	9-5
Configuring Trusted URLs	9-6
Blocking URLs	9-8
Using a Local List	9-8

Chapter 10: URL Filtering

Introducing URL Filtering	10-2
URL Filtering Actions	10-3
URL Filtering Workflow	10-4
Managing URL Filtering Policies	10-5
Enabling URL Filtering	10-5
Creating a New Policy	10-6
Modifying and Deleting Policies	10-8
URL Filtering Settings	10-9
Creating Custom Categories	10-9
Requesting URL Reclassification and URL Lookup	10-11
Unrated and Unknown URLs	10-11
Requesting a Reclassification	10-11
Scheduled Time Settings	10-12
URL Access Warning TTL	10-13
URL Filtering Exceptions	10-13
URL Filtering Time Quota Extension	10-14

Chapter 11: FTP Scanning

Introduction	11-2
--------------------	------

FTP Settings	11-2
Proxy Settings	11-3
Passive and Active FTP	11-3
Client Requests	11-3
FTP Scanning Options	11-4
Enabling FTP Traffic and FTP Scanning	11-5
Scan Direction	11-6
File Blocking	11-6
File Scanning	11-6
Priority for FTP Scan Configuration	11-6
Intellitrapp	11-7
Compressed File Handling	11-7
Large File Handling	11-7
Encrypting Quarantined Files	11-8
Scanning for Spyware/Grayware	11-8
Data Loss Prevention	11-8
FTP Scanning Exception List	11-8
Configuring FTP Scanning Settings	11-8
Setting Scan Actions on Viruses	11-10
FTP General Configuration Settings	11-11
Proxy Settings	11-12
Data Connection	11-12
FTP Access Control Settings	11-13
By Client IP	11-13
Via Approved Server IP List	11-14
Via Destination Ports	11-15

Chapter 12: Command Line Interface Commands

SSH Access	12-2
Preventing Password Brute Force Attacks through SSH	12-2
Command Modes	12-3
Command List	12-3

Chapter 13: Reports, Logs, and Notifications

Introduction to Reports	13-2
Report Information	13-2
Report Settings	13-2
Email This Report	13-3
Report By (Users and Groups)	13-3
Types of Reports	13-3
Generating Reports	13-5
Configuring Reports	13-5
Report Types	13-7
Scheduling Reports	13-8
Saved Scheduled Reports	13-9
Introduction to Logs	13-9
Bandwidth	13-10
Policy Enforcement	13-10
Internet Access	13-11
Internet Security	13-11
Data Security	13-12
Access Control	13-12
Options for Recording Data	13-13
Querying and Viewing Logs	13-13
Log Settings	13-13
Global Log Filtering	13-14
Anonymous Logging	13-14
Exporting Log and Report Data as CSV Files	13-14
Exporting Report Data as PDF Files	13-15
Syslog Configuration	13-15
Introduction to Notifications	13-16
Notification Email Settings	13-17
Notification Tokens/Parameters	13-17
Configuring Notifications	13-24
Using HTML Tags in User Notifications	13-24
Configuring Applets and ActiveX Security	
Notification Settings	13-25
Configuring C&C Contact Callback Notifications	13-25

Configuring Data Loss Prevention Notifications	13-26
Configuring FTP Data Loss Prevention Notifications	13-27
Configuring FTP Blocked File Type Notifications	13-28
Configuring FTP Scanning Notification Settings	13-29
Configuring HTTP/HTTPS File Blocking Notifications	13-29
Configure HTTP/HTTPS Scanning Notifications	13-30
Configuring HTTPS Access Denied Notifications	13-31
Configuring HTTPS Certificate Failure Notifications	13-32
Configuring HTTP/HTTPS Access Denied by Application Control Notifications	13-33
Enabling Pattern File Updates Notifications	13-33
Configuring Threshold Alert Settings	13-34
Configuring URL Access Warning Notifications	13-34
Configuring URL Access Override Notifications	13-36
Configuring a URL Blocking by Access Control Notification	13-37
Configuring a URL Blocking by HTTP Inspection Notification	13-38
Configuring a URL Blocking by URL Filtering Notification	13-39
Enabling Notifications for URL Filtering Engine and Scan Engine Updates	13-39
Configuring URL Filtering by Time Quota Notification Settings	13-40
Enabling SNMP Trap Notifications	13-40
Enabling MAC Address Client Identification	13-42

Chapter 14: Administration

Overview	14-2
Audit Log	14-3
IWSVA Configuration	14-3
User Identification	14-4
User/Group Authentication Settings	14-4
Captive Portal	14-7
None	14-9
Policy Acknowledgement Screen	14-9

Basic Mode	14-10
Authentication White List	14-11
Policy Deployment	14-11
Database Connection	14-11
Quarantine Management	14-12
Quarantine Directory	14-12
Encrypting Quarantined Files	14-12
System Time	14-13
System Time Settings	14-13
Time Zone	14-13
Scheduled Times	14-14
Scheduled Time Settings	14-14
Adding Scheduled Times	14-15
Register to Control Manager	14-15
Replication Configuration	14-16
Central Log/Reporting	14-17
Network Configuration	14-18
Network Interface	14-18
Web Console	14-19
Remote CLI	14-19
SNMP Settings	14-20
System Information Setup	14-20
Access Control Setup	14-20
Static Routes	14-21
Configuring Static Routes	14-21
Management Console	14-22
Account Administration	14-22
Login Accounts	14-22
Access Control Settings	14-23
Syslog Server	14-24
Config Backup/Restore	14-24
System Updates	14-25
System Maintenance	14-26
System Event Log	14-27
Product License	14-27

License Expiration Warning	14-28
Registering IWSVA	14-28
Obtaining a Registration Key	14-29
Obtaining and Entering an Activation Code	14-30
Updating Your License	14-30
Renewing a Maintenance Agreement	14-30
Support	14-31
Network Packet Capturing	14-32
Using Network Packet Capturing	14-32
Verbose Log	14-33
Deployment Diagnostic	14-33

Chapter 15: Testing and Configuring IWSVA

EICAR Test File	15-2
Testing Web Reputation	15-2
Testing Upload Scanning	15-3
Testing HTTPS Decryption Scanning	15-3
Testing FTP Scanning	15-7
Testing Application Control	15-8
Testing HTTP Inspection	15-10
Testing URL Monitoring	15-11
Testing Download Scanning	15-12
Testing URL Filtering	15-13
Testing Spyware Scanning	15-13
Testing Java Applet and ActiveX Scanning	15-14
Additional IWSVA Configurations	15-15
Configuring the Separate Management Interface	15-15
Securing the IWSVA Console	15-17
Activating Remote CLI	15-18
Specifying Advanced Threat Protection Scans	15-18
Specifying the User Identification Method	15-19

Enabling the Guest Account (LDAP only)	15-19
Reviewing Scanning and Filtering Policies	15-19
Enabling Access Quota Policies	15-19
Setting Internet Access Control Settings	15-20
Adding System Updates or Removing an Application Patch	15-21
About Hot Fixes, Patches, and Service Packs	15-21
Checking the Database Connection	15-22
Changing the Management Console Password	15-23
Configurations After Changing the Web Console	
Listening Port	15-24
Verifying URL Filtering Settings	15-24
IWSVA Performance Tuning	15-25
LDAP Performance Tuning	15-26
LDAP Internal Caches	15-26
Disable Verbose Logging When LDAP Enabled	15-27

Appendix A: Contact Information and Web-based Resources

Contacting Technical Support	A-2
IWSVA Core Files for Support	A-2
Knowledge Base	A-3
Sending Suspicious Code to Trend Micro	A-3
TrendLabs	A-4
Security Information Center	A-5
TrendEdge	A-7

Appendix B: Mapping File Types to MIME Content-types

Overview	B-2
File Type Mapping Table for MIME Content Files	B-4
.....	B-23

Appendix C: Architecture and Configuration Files

Main Components	C-2
Main Services	C-2

Scheduled Tasks	C-3
About Configuration Files	C-4
Protocol Handlers	C-6
Scanning Modules	C-6

Appendix D: OpenLDAP Reference

OpenLDAP Server Side Configuration	D-2
Software Package Dependencies	D-2
Configuration Files	D-2
Sample ldap.conf	D-2
Sample slapd.conf	D-3
Tools	D-7

Appendix E: Best Practices for IWSVA

Authenticating Multiple Users on Shared Personal Computers	E-2
Best Practice Suggestions	E-2
Leveraging Microsoft ShellRunas Utility	E-2
Scanning Considerations	E-2
Smart Protection Network - Cloud Based Services	E-3
Best Practice Suggestions	E-3
Local IWSVA Scan Engines	E-4
Best Practice Suggestions	E-5

Appendix F: WCCP Deployment & Troubleshooting

Introduction to WCCP	F-2
IWSVA and WCCP Overview	F-2
Deploying WCCP on Cisco 2821 Routers	F-3
Deployment Example	F-3
Configuring the Cisco 2821 Router	F-4
Deploying WCCP on Cisco 3750 Switches	F-6
Deployment Example	F-7
Configuring the Cisco 3750 Switch	F-8

Deploying WCCP on Cisco ASA Devices	F-9
Deployment Example	F-9
Configuring the Cisco ASA	F-10
Configuring IWSVA with WCCP Deployment Mode	F-11
Configuring WCCP on IWSVA Device	F-12
Additional IWSVA Tips	F-15
IWSVA's WCCP Configuration File	F-15
Changing the Default WCCP Service	F-18
Advanced Concepts: Deploying WCCP for Redundancy and Fault Tolerance	F-20
Configuring the Cisco Routers	F-21
Cisco Router One	F-21
Cisco Router Two	F-22
Configuring the IWSVA Device	F-23
Troubleshooting Cisco WCCP & IWSVA	F-23
Enabling IWSVA's WCCP Event Logging	F-24
Enabling Cisco Device's WCCP Event Logging	F-25
Starting the Troubleshooting Process	F-25
Checking the IWSVA Configuration	F-26
Checking the WCCP Registration Activity	F-29
What to Look for in the Packet Debug	F-31
What to Look for in the Packet Debug	F-32
Checking the Packet Redirection	F-32
Verifying the Packet Flow on IWSVA	F-34

Appendix G: URL Filtering Category Mapping

URL Filtering Category Mapping Table.	G-2
--	-----

Appendix H: URL Filtering Category Groups

URL Filtering Categories	H-2
--------------------------------	-----

Appendix I: Application List

Preface

Preface

Welcome to the *Trend Micro™ InterScan™ Web Security Virtual Appliance 6.0 Administrator's Guide*. This guide provides detailed information about the InterScan Web Security Virtual Appliance (IWSVA) configuration options. Topics include how to update your software to keep protection current against the latest risks, how to configure and use policies to support your security objectives, configuring scanning, configuring URL blocking and filtering, and using logs and reports.

This preface describes the following topics:

- *IWSVA Documentation*
- *Audience*
- *Document Conventions*
- *About Trend Micro*

IWSVA Documentation

In addition to the *Trend Micro™ InterScan Web Security Virtual Appliance Administrator's Guide*, the documentation set for IWSVA includes the following:

- **Installation Guide**—This guide helps you get “up and running” by introducing IWSVA, assisting with installation planning, implementation, and configuration, and describing the main post-upgrade configuration tasks. It also includes instructions on testing your installation using a harmless test virus, troubleshooting, and accessing Support.
- **Online Help**—The purpose of Online Help is to provide “how to’s” for the main product tasks, usage advice, and field-specific information such as valid parameter ranges and optimal values. Online Help is accessible from the IWSVA Web console.
- **Readme file**—This file contains late-breaking product information that is not found in the online or printed documentation. Topics include a description of new features, installation tips, known issues and, release history.

The latest versions of the Installation Guide, Administrator's Guide and readme file are available in electronic form at:

<http://www.trendmicro.com/download/>

- **Knowledge Base**— The Knowledge Base is an online database of problem-solving and troubleshooting information. It provides the latest information about known product issues. To access the Knowledge Base, open:

<http://esupport.trendmicro.com/en-us/business/pages/technical-support.aspx>

- **TrendEdge**—A program for Trend Micro employees, partners, and other interested parties that provides information on unsupported, innovative techniques, tools, and best practices for Trend Micro products. The TrendEdge database contains numerous documents covering a wide range of topics.

<http://trendedge.trendmicro.com>

Audience

The IWSVA documentation is written for IT managers and system administrators working in enterprise environments. The documentation assumes that the reader has in-depth knowledge of networks schemas, including details related to the following:

- HTTP, HTTPS, FTP and other Internet protocols used by an enterprise
- VMware ESX administration experience when installing on VMware ESX and Microsoft Hyper-V experience when installing on Hyper-V

The documentation does not assume the reader has any knowledge of antivirus or Web security technology.

Note: Silicom bypass cards are recognized by VMware and can be used as normal network cards.

Document Conventions

To help you locate and interpret information easily, the IWSVA documentation uses the following conventions.

TABLE 0-1. Document Conventions

CONVENTION	DESCRIPTION
ALL CAPITALS	Acronyms, abbreviations, and names of certain commands and keys on the keyboard
Bold	Menus and menu commands, command buttons, tabs, options, and ScanMail tasks
<i>Italics</i>	References to other documentation
Monospace	Examples, sample command lines, program code, Web URL, file name, and program output
Note:	Configuration notes

TABLE 0-1. Document Conventions (Continued)

CONVENTION	DESCRIPTION
<u>Tip:</u>	Recommendations
WARNING!	Reminders on actions or configurations that should be avoided

About Trend Micro

Trend Micro, Inc. is a global leader in network antivirus and Internet content security software and services. Founded in 1988, Trend Micro led the migration of virus protection from the desktop to the network server and the Internet gateway-gaining a reputation for vision and technological innovation along the way.

Today, Trend Micro focuses on providing customers with comprehensive security strategies to manage the impacts of risks to information, by offering centrally controlled server-based virus protection and content-filtering products and services. By protecting information that flows through Internet gateways, email servers, and file servers, Trend Micro allows companies and service providers worldwide to stop viruses and other malicious code from a central point, before they ever reach the desktop.

For more information, or to download evaluation copies of Trend Micro products, visit our award-winning Web site:

<http://www.trendmicro.com>

Chapter 1

Introducing Trend Micro™ InterScan™ Web Security Virtual Appliance

This chapter introduces the Trend Micro™ InterScan™ Web Security Virtual Appliance (IWSVA) and how it helps to ensure your organization's gateway security.

Topics in this chapter include the following:

- [Main Features starting on page 1-2](#)
- [What's New? starting on page 1-12](#)
- [System Specifications starting on page 1-12](#)
- [System Status starting on page 1-14](#)
- [Dashboard starting on page 1-20](#)
- [Web Traffic Security Risk Overview starting on page 1-22](#)

Main Features

The following IWSVA features help you maintain Internet gateway security.

Application Control

The Application Control feature provides a security technology that automates the discovery of popular Internet applications and allows administrators to control them using policies. See details at: [Application Control Overview on page 5-2](#).

Traffic Monitoring and Reporting

The Application Control real-time traffic monitoring tab shows bandwidth used by inbound and outbound traffic as well as the number and type of concurrent application connections. Details on which applications are being by specific end-users is available in the reporting section of the product. See details at: [Traffic Monitoring Overview on page 5-9](#).

HTTP Inspection

HTTP Inspection allows administrators to identify behavior and filter web traffic according to HTTP methods, URLs, and headers. It also allows them to create filters or use default filters to identify web traffic, as well as import and export filters. After the traffic is identified, IWSVA can control it according to policy settings that determine the appropriate actions for specific traffic. For example, an HTTP Inspection policy could prevent users from posting content on social networking or webmail sites while still allowing them to read content. See details at: [HTTP Inspection Overview on page 8-3](#).

Password Override Action for Blocked URL Filtering Categories

The “blocked with override” feature allows administrators to set a category of URLs to be blocked and then allow certain users to override the block action by typing a password. See details at: [URL Filtering Actions on page 10-3](#).

Time Limit Action for URL Filtering

Along with the Allow, Block, Monitor, and Warn actions available for URL Filtering policies, there is a new Time Limit action that sets a time quota for selected URL categories, limiting the amount of Web browsing for that category. See more at: [URL Filtering Actions on page 10-3](#).

Time Quota Extension for URL Filtering Time Limit Action

If the time limit action is used for URL Filtering policies, there may be a need to allow a time extension for browsing. In that case, the Time Quota Extension feature allows administrators to add time for users to browse, if needed. For more information, see: [URL Filtering Time Quota Extension on page 10-14](#).

Data Loss Prevention

For convenience, IWSVA includes default content filtering data leakage prevention (DLP) policies. There are 10 default data leakage prevention policies configured by region. Compared to standard content filtering policies, keywords in the data leakage prevention policies are regular expression description strings and not the actual keyword.

For example, IBAN is the description for the regular expression:

```
[^\w](((\d{2}\s?)|([A-Za-z0-9]{11,27}|([A-Za-z0-9]{4}\s){3,6}[A-Za-z0-9]{0,3}|([A-Za-z0-9]{4}\s){2}[A-Za-z0-9]{3,4})))
```

Messages that contain the string "IBAN" do not trigger this policy. Strings such as "BE68 5390 0754 7034 " will match the regular expression and trigger this policy.

Data Loss Prevention utilizes customizable data identifiers, templates, and policies to define, monitor, and protect your company-specific sensitive data from intentional or accidental loss.

Before you can monitor sensitive data for potential loss, you must be able to answer the following questions:

- What data needs protection from unauthorized users?
- How does the sensitive information transmit through the network?

- What users have permission to access or transmit the sensitive data?
- What action should occur if a security violation occurs?

This important audit typically involves multiple departments and personnel familiar with the sensitive information in your organization.

If you already defined your sensitive information and security policies, you can begin to define templates and company policies in the Data Loss Prevention system.

Data Identifier Types

Digital assets are files and data that an organization must protect against unauthorized transmission. You can define digital assets using the following data identifiers:

- **Expressions:** Data that has a certain structure. For details, see [Expressions](#) on page 1-4.
- **Keyword Lists:** A list of special words or phrases. For details, see [Keyword Lists](#) on page 1-5.

Expressions

An expression is data that has a certain structure. For example, credit card numbers typically have 16 digits and appear in the format “nnnn-nnnn-nnnn-nnnn,” making them suitable for expression-based detections.

Predefined Expressions

IWSVA comes with a set of predefined expressions. These expressions cannot be modified or deleted.

IWSVA verifies these expressions using pattern matching and mathematical equations. After IWSVA matches potentially sensitive data with an expression, the data may also undergo additional verification checks.

Keyword Lists

Keywords are special words or phrases. You can add related keywords to a keyword list to identify specific types of data. For example, “prognosis,” “blood type,” “vaccination,” and “physician” are keywords that may appear in a medical certificate. If you want to prevent the transmission of medical certificate files, you can use these keywords in a DLP policy and then configure IWSVA to block files containing these keywords.

Commonly used words can be combined to form meaningful keywords. For example, “end,” “read,” “if,” and “at” can be combined to form keywords found in source codes, such as “END-IF,” “END-READ,” and “AT END.”

Predefined Keyword Lists

IWSVA comes with a set of predefined keyword lists. These keyword lists cannot be modified or deleted. Each list has its own built-in conditions that determine if the template should trigger a policy violation.

Data Loss Prevention Templates

Use Data Loss Prevention templates to tag and detect sensitive content by a set combination of data identifiers. A template combines data identifiers and operators (And, Or) in condition statements. When a set of data matches the criteria of a condition, Data Loss Prevention triggers a policy action. For example, a file containing data matching the All: Names from US Census Bureau AND US: HICN (Health Insurance Claim Number) templates, triggers the HIPAA policy.

You can use some Data Loss Prevention out-of-the-box templates for regulatory compliance initiatives, such as GLBA, PCI-DSS, SB-1386, US PII, and HIPAA. Companies can also create custom templates or modify existing templates to suit their business requirements. Companies that have pre-existing, user-defined templates can import and export templates to maintain policy consistency throughout their organization.

Data Loss Prevention Policies

Data Loss Prevention policies allow companies to monitor the flow of sensitive information over the network. Policy rules, through use of Data Loss Prevention templates, help to manage the distribution of sensitive data across the network. Administrators can scale policies to apply to the entire company, groups, or specific endpoints.

Administrators can apply policies to both outbound and inbound mail traffic, as well as to the exact message parts to monitor. Policy configurations can exempt certain groups or users from scans and define specific incident response actions.

IWSVA integrates Data Loss Prevention policy management with Control Manager 6.0. Administrators can create and manage the company's Data Loss Prevention policies from the Control Manager console and deploy the settings to all IWSVA servers registered to Control Manager.

Advanced Threat Protection

IWSVA scans the HTTP traffic flow to detect viruses and other security risks in uploads and downloads. HTTP scanning is highly configurable—for example, you can set the types of files to block at the HTTP gateway and how IWSVA scans compressed and large files to prevent performance issues and browser timeouts. In addition, IWSVA scans for many types of spyware, grayware, and other risks.

HTTPS Decryption

IWSVA closes the HTTPS security loophole by decrypting and inspecting encrypted content. You can define policies to decrypt HTTPS traffic from selected Web categories. While decrypted, data is treated the same way as HTTP traffic to which URL filtering and scanning rules can be applied.

Web Reputation

Web Reputation guards end-users against emerging Web threats. It can improve the Web surfing experience by enhancing Web filtering performance. Because a Web Reputation query returns URL category information (used by the URL Filtering module), IWSVA no longer uses a locally stored URL database.

Web Reputation also assigns reputation scores to URLs. For each accessed URL, IWSVA queries Web Reputation for a reputation score and then takes the necessary action, based on whether this score is below or above the user-specified sensitivity level.

IWSVA enables you to provide feedback on infected URLs, which helps to improve the Web Reputation database. This feedback includes product name and version, URL, and virus name. (It does not include IP information, so all feedback is anonymous and protects company information.) IWSVA also enables you to monitor the effectiveness of Web Reputation without affecting existing Web-access policies. Results are located in the URL Blocking Log and the Summary page (Security Risk Report tab).

For more Web Reputation information, see [Specifying Web Reputation Rules on page 8-42](#) and [Web Reputation Settings on page 8-44](#).

High Availability

IWSVA supports high availability (HA) for service redundancy, providing active/passive failover in Transparent Bridge mode to ensure continuity in demanding business environments. HA in IWSVA is easily deployed through the Deployment Wizard and managed through the new cluster management feature. See [High Availability Overview on page 3-2](#) for more information.

FTP Scanning

In addition to scanning FTP uploads and downloads, IWSVA can also block specified file types at the FTP gateway. To prevent performance issues, the FTP scanning module supports special configurations for compressed files and large files. Spyware and grayware scanning is also supported.

IWSVA FTP scanning can be deployed onto your environment in conjunction with another FTP proxy server, or IWSVA can act as an FTP proxy. To help ensure the security of Trend Micro™ InterScan™ Web Security Virtual Appliance, several security-related configurations are available to control access to IWSVA and its ports.

URL Filtering

With the URL Filtering option in IWSVA, you can set policies based on categories of URLs, such as “Adult”, “Gambling,” and “Financial Services.” When a user requests a URL, IWSVA first looks up the category for that URL and then allows, denies, or monitors access to the URL based on the policies you have set up. You can also define a list of approved URLs that will not be filtered.

Content Caching

Web content caching is the caching of Web objects (for example, HTML pages, images) to reduce bandwidth usage, server load, and perceived lag. A Web cache stores copies of objects passing through it. Subsequent duplicate requests may be satisfied from the cache if certain conditions are met. The Content Cache capability provides users who access the Web through IWSVA with a quicker experience while saving bandwidth. See [Using the Content Cache on page 8-47](#) for details.

IP Address, Host Name and LDAP-based Client Identification

IWSVA supports configuring policies for HTTPS decryption, HTTP virus scanning, Applets and ActiveX security, URL filtering, Application Control, and access quotas. The scope of policies can be configured using client IP address, host name or LDAP user or group name.

Hyper-V Installation Support

IWSVA now supports installation on Microsoft® Hyper-V® 2.0 with Windows Server 2008 R2 or later. The IWSVA installation for Hyper-V platforms supports forward proxy mode, WCCP mode, ICAP mode, and reverse proxy mode. See Appendix F of the *IWSVA Installation Guide* for more information.

Notifications

IWSVA can issue several types of notifications in response to program or security events. Administrator notifications are sent through email to the designated administrator contacts. User notifications are presented in the requesting client's browser. Both administrator and user notifications can be customized.

To work with network management tools, IWSVA can also issue several types of notifications as SNMP traps. IWSVA sends traps for security risk detections, security violations, program and pattern file updates, and service disruptions.

Because IntelliTrap is considered a type of security risk, it uses the same notifications as Advanced Threat Protection.

Real-time Statistics and Alerts

IWSVA provides dynamic statistics where the administrator can view the “real-time” information about the IWSVA system. Real-time statistics are displayed as graphs and tables in the System Dashboard tab of the Summary page. These statistics include the following:

- Hard Drive
Hard drive statistics are static and are only updated when you open the Summary page.
- Concurrent Connections
- CPU Usage
- Physical Memory Usage

Logs and Reports

IWSVA includes many pre-configured reports to provide a summary of your gateway security status. Reports can be run for a specific time period and customized to only provide information about clients that you are interested in. The following lists the main report classes:

- Internet Access
- Internet Security
- Bandwidth

- Policy Enforcement
- Data Security

Reports are generated from log information in the database. IWSVA writes log information to text-only logs, text and database logs, or database-only logs.

Reports can be generated on demand or scheduled on a daily, weekly, or monthly basis. Log and report data can be exported to comma-separated value (CSV) files for further analysis. To prevent logs from consuming excessive disk space, a scheduled task deletes older logs from the server.

For more information, see [Reports, Logs, and Notifications on page 13-1](#).

Syslog Support

To provide enterprise-class logging capabilities, IWSVA allows sending logs using the syslog protocol (default UDP port 514) to multiple external syslog servers in a structured format.

Integration with Cisco WCCP

IWSVA supports Web Cache Communication Protocol (WCCP) version 2, a protocol defined by Cisco Systems. See your Cisco product documentation for more information on the protocol.

The following are the benefits gained when IWSVA supports WCCP:

- Transparency of deployment without endpoint configuration
- High availability and load balancing between multiple IWSVA systems
- Automated load balancing re-configuration when adding or removing IWSVA appliances
- Support Cisco router, switch, and firewall implementations of the protocol

The WCCP implementation for IWSVA is compatible with Cisco routers, switches, PIX firewalls, and ASA security devices.

Trend Micro recommends using the following Cisco IOS versions when configuring WCCP with IWSVA:

- 12.2(0) to 12.2(22). Avoid using releases 23 and above within the 12.2 family
- 12.3(10) and above. Avoid using releases 0-9 in the 12.3 family
- IOS 15.1(1)T3 or above

Trend Micro recommends using version 7.2(3) and above for the Cisco PIX firewall and avoiding version 7.2(2).

Non-Cisco devices that support WCCP version 2 have not been explicitly tested by Trend Micro. Therefore, interoperability cannot be guaranteed.

Reverse Proxy Support

IWSVA is usually installed close to clients to protect them from Internet security risks. However, IWSVA also supports being installed as a reverse proxy to protect a Web server from having malicious programs uploaded to it. As a reverse proxy, IWSVA is installed close to the Web server that it protects. IWSVA receives client requests, scans all content and then redirects the HTTP requests to the real Web server.

For more information, see [Reverse Proxy on page 6-9](#).

Support for Multiple Trend Micro™ InterScan™ Web Security Virtual Appliance Installations

The method to fully administer multiple IWSVA devices from a single console is done through Trend Micro Control Manager (TMCM) for the InterScan Web Security product family. TMCM provides the ability to manage multiple Trend Micro products and allows you to activate multiple IWSVA units from a central console.

Command Line Interface

IWSVA provides a native Command Line Interface (CLI) to perform system monitoring, system administration, debug, troubleshooting functions and more through a secure shell or a direct console connection.

IWSVA's CLI uses industry standard syntax to provide a familiar interface for configuring the appliance. For security, IWSVA allows administrators to access the CLI through the console or an SSH connection only. You can enable this feature in the IWSVA Web console.

What's New?

The following features are new in this release:

- Granular Application Control
 - Instant Messaging
 - Mail and Collaboration
 - Social Networking
 - Social Media
- Schedule Object Support
- Log filtering
 - By userID or domain name
- Anonymous logging
- Central log enhancement: View the log source list and status from the log server
- Configuration Replication enhancement: View the replication receiver list and status from the replication source and trigger manual replication from the replication source
- HTTPS Tunneling
 - Domain Tunneling
 - Failed HTTPS Accesses

System Specifications

Web-based Browser Requirements

- Internet Explorer (IE) 8.0, 9.0, 10
- Firefox 15+
- Chrome 22+

Hardware Requirements

For a complete description of the minimum IWSVA server requirements and to install for a basic evaluation, see the Installation Guide.

The minimum requirements specified provide enough resources to properly evaluate the product under light traffic loads. The recommended requirements specified provide general production sizing guidance.

For more detailed sizing information, refer to the *IWSVA Sizing Guide* at:

<http://trendedge.trendmicro.com/pr/tm/te/web-security.aspx>

Search for “sizing guide.”

Minimum Requirements:

- Single 2.0 GHz Intel™ Core2Duo™ 64-bit processor supporting Intel VT™ or equivalent
- 4GB RAM
- 20GB of disk space (IWSVA automatically partitions the detected disk space as required)
- Monitor that supports 1280x1024 resolution with 32-bit true color

Recommended Requirements:

- Dual 3.16 GHz Intel QuadCore™ 64-bit processor or equivalent
- 300GB of disk space or more and 16GB RAM for log intensive environments. IWSVA automatically partitions the detected disk space as per recommended Linux practices

For more information on capacity sizing, refer to the *IWSVA Sizing Guide* at:

<http://trendedge.trendmicro.com/pr/tm/te/web-security.aspx>

Compatible Directory Servers for End-User Authentication

- Microsoft Active Directory™ 2003, 2008, and 2012
- Linux OpenLDAP Directory 2.2.16 or 2.3.39
- Sun™ Java System Directory Server 5.2 (formerly Sun™ ONE Directory Server)

Integration with ICAP 1.0-compliant Caching Devices

Cache servers help moderate Web traffic congestion and save bandwidth. The “retrieve once, serve many” method employed by cache servers permits integration with third-party applications such as virus scanning through IWSVA. An open protocol, Internet Caching Acceleration Protocol (ICAP), allows seamless coupling of caching and virus protection. IWSVA works with cache servers that support the ICAP 1.0 standard.

X-Authenticated ICAP Headers Support

IWSVA supports X-Authenticated ICAP Headers that are provided by supported ICAP clients, such as NetCache (5.6.2R1+) and Blue Coat (SGOS 4.2.1.1+). The X-Authenticated Headers come in two forms: X-Authenticated-User and X-Authenticated-Groups. The advantage of using X-Authenticated Headers is two-fold: first, it reduces LDAP query overhead in IWSVA and second, it allows ICAP clients to provide LDAP searches on LDAP servers with different schemas.

System Status

The IWSVA console opens to the Dashboard screen that displays real-time, dynamic system information. Other available reports display static information. Information on the System Status page provides access to the following:

- [Enabling Threshold Alert Settings](#)
- [Concurrent Connections Display](#) status
- [Interface Status](#)
- [CPU Usage Display](#)
- [Physical Memory Usage Display](#)
- [Hardware Status](#)
- [Hard Drive Display](#)

Enabling Threshold Alert Settings

You can specify threshold alert values and the frequency of alerts so that you are notified when the level of any of the following items reaches a critical level:

- Virus
- Spyware
- Database
- Hard drive
- Bandwidth

IWSVA can send these alerts either through email, SNMP trap/notification (if enabled), or both. See [Notification Email Settings](#) on page 13-17.

Note: Configure threshold alert settings for email notifications. Threshold alert settings do not affect when IWSVA sends SNMP traps.

To enable threshold alerts:

1. Click **System Status** in the main menu, then click **Threshold Alerts**.
2. Under **Thresholds**, specify the desired thresholds and either accept the defaults or specify new values in the **Threshold Value** and **Limit 1 Notification Every** columns.
3. If you do not want to use the default notification messages under **Notification Message**, highlight the default text and type your own version. If applicable, insert variables in the text as described in [Notification Tokens/Parameters starting on page 13-17](#).
4. Click **Save**.

Concurrent Connections Display

This dynamic display shows concurrent connections usage for HTTP/HTTPS in purple and FTP in orange. It shows the number of connections and connection time (in seconds.)





This display can have two graphs: one for FTP and the other for HTTP(S). For FTP, the connection measured is the session for both commands and data. For HTTP(S), the connection measured is the session for both requests and responses. The default refresh

rate is 30 seconds. Both the X and Y axis scales are variable. The X axis scale is determined by the set refresh rate and the Y axis scale is determined by the number of concurrent connections at a given time.

Interface Status

Icons shown [Table 1-1](#) represent the status of the interfaces:

TABLE 1-1. Interface Status Indicators

ICON	DESCRIPTION
	Link not detected. Could be an empty port, cable may be loose or broken, or the peer machine may be down.
	Link OK
	Link error
	Link disabled
D	Data interface
M	Management interface
H	High availability interface

Hardware Status

The Hardware Status feature provides the administrator with the ability to monitor hardware information about fans, voltage, temperature, and so on. on Intelligent Platform Management Interface (IPMI)-enabled devices.

Note: IWSVA hardware monitoring is only compatible with the Baseboard Management Controller (BMC) with Intelligent Platform Management Interface (IPMI) v2.0 support installed on bare metal.

Administrators can query the hardware status information using the IWSVA Web console or by SNMP request. If SNMP trap is enabled, an alert will be sent when system events are detected, such as “temperature threshold exceeded,” “voltage threshold exceeded,” and so on.

Alerts can be sent to notify administrators of any problems. They are configured at: **Notification > SNMP Notifications Settings > Hardware monitoring events** (check box).

The following provides a brief description of the options available on the Hardware Status screen:

- **Hardware Type**—shows Voltage, Fan, CPU, Storage and Temperature statistics
- **Status**—shows the current status of the hardware. Usually it shows “Normal,” but if an abnormal event occurs, it displays Critical or Failed, depending on the event. The five available status are:
 - **Normal**—Component status is ok
 - **Warning**—Component status is compromised
 - **Critical**—Component status is in danger of failing
 - **Failed**—Component is not working
 - **Unknown**—No component information is available
- **Sensor Information**—displays information about the status of the type of hardware monitored.

SNMP Queries and Traps

Administrators can poll the hardware status using SNMP queries and receive alerts through SNMP traps. To do this, administrators need import the hardware-monitoring MIB file into an SNMP tool like iReasoning MIB Browser.

IWSVA also supports two standard MIB files for network interface card statistics:

- RFC1213-MIB
- HOST-RESOURCES-MIB

These are available from:

<http://www.simpleweb.org/ietf/mibs/>

The third Trend Micro-specific MIB for hardware events monitoring is:
TM-HWMONITOR-MIB

located on the Trend Micro download site at:

<http://www.trendmicro.com/ftp/documentation/guides/MIBs.zip>

To receive traps from IWSVA, administrators need configure the SNMP trap destination at **Administration > Network Configuration > SNMP Settings**.

CPU Usage Display

This is a dynamic display that shows CPU utilization on the local system. In the case of multiple CPUs, the display shows the average IWSVA usage across all CPUs. It does this by displaying a single line for all CPU utilization. IWSVA determines the CPU utilization based on CPU cycles used, CPU cycles used by IWSVA, and total CPU cycles used by the backend, CPU-monitoring API.

By default, IWSVA samples the CPU usage each second for two minutes, giving you 120 data points. In the init file, you can change the default refresh rate.

Clicking the 1-day or 30-day button opens a window that shows a static chart with one or 30 days of CPU usage, respectively. IWSVA retrieves this information from the database. If the database does not contain enough data, then the display shows the data that is available.

Note: The 30-day display option shows each day's CPU usage data by a single point. For the 1-day display option, the screen shows the CPU usage for each hour of the day by a single point. IWSVA cannot start graphing data until there are at least two points worth of data available.

Physical Memory Usage Display

This is a dynamic display that shows the amount of physical memory used by the local IWSVA server.

By default, IWSVA samples the physical memory usage each second for two minutes, giving you 120 data points. In the init file, you can change the default refresh rate.

Clicking the 1-day or 30-day button opens a window that shows a static chart with one or 30 days of physical memory usage, respectively. IWSVA retrieves this information from the database. If the database does not contain all the data, the display shows the data that is available.

Note: The 30-day display option shows each day's physical memory usage data by a single point. For the 1-day display option, the screen shows the physical memory usage for each hour of the day by a single point. IWSVA cannot start graphing data until there are at least two points worth of data available.

Manual Updates on page 4-10 for more information.

Hard Drive Display

This is a static display that shows the status of the disk(s) used by IWSVA for its system files, quarantine space, temporary space, and logs. The Hard Drive display can monitor up to 12 disks.

If the database resides on the same drive as any of these directories, then the database disk usage is also included in the display. The scale along the Y-axis ranges from 10 to 100 percent.

You can specify threshold alert values and the frequency of alerts so that you are notified when any of the hard disk statuses reach a critical level. IWSVA can send these alerts either through email, SNMP trap/notification (if enabled), or both. SNMP traps are sent when a configured threshold value is met.

Accessing Additional Web Threat Information

From the **Threat Resources** drop-down list in the upper right corner of the **System Status** page, you can access the links to Trend Micro's Web threat protection sites to learn more about the latest Web threats, research from where various Web threats are

originating, access Trend's Threat Encyclopedia, and see real-time Web and email malware statistics. See [Enabling Advanced Threat Protection and Applets and ActiveX Security on page 8-2](#) to view the **Threat Resources** drop-down list.



FIGURE 1-1. Web threat protection technologies that can be accessed in IWSVA

Dashboard

The dashboard indicates whether the network or IWSVA is performing normally, the amount of traffic or Internet usage is consistent and within the norm, and if there is unusual virus activity somewhere on the network. The IWSVA dashboard shows a summary of transactions that have occurred in the last one, 12, and 24 hours, as well as the last week-long increments.

IWSVA provides dynamic displays where you can view the “real-time” statistics of the IWSVA server.

Also, above the left menu on every page, IWSVA provides a Search field where you can enter a feature name and be directed to the appropriate page for that feature.

Note: Role-based access rights are not breached by the Search feature.

- **Top URL Categories Accessed** - This widget shows URL category-related violations. Also, the time period displayed can show information for the last hour, day, week, or month. Also, the time period displayed can show information for the last hour, day, week, or month. Users can refresh the data manually by clicking Refresh icon in the upper right corner of the widget. The default display is bar-chart style, but it can be toggled to display in table format. To configure how many sources to be displayed, click the Edit icon beside Refresh icon, and set the needed value in the pop-up window.
- **Top Users Blocked by Internet Security (default)** - Shows which users access the most blocked sites for a specified range of time to help understand the user-awareness of Internet security and acceptable usage. Defaults: Top 5, Last 1 Day
- **Top URL Categories Blocked (default)** - Shows the URL categories being blocked the most for a specified range of time to provide high-level view of potential security, bandwidth, and productivity problems. Defaults: Top 5, Last 1 Day
- **Application Bandwidth (default)** - Shows the traffic trend of bandwidth (kbps) by Application usage for a specified range of time. Default time period: Last 1 Day.
- **Top Blocked Applications** - Shows the application categories being blocked the most for a specified range of time to provide high-level view of potential security, bandwidth, and productivity problems. Defaults: Top 5, Last 1 Day
- **Payload** - This is a dynamic display that can have two graphs: one for FTP and the other for HTTP(S). For FTP, the connection measured is the session for both commands and data. For HTTP(S), the connection measured is the session for both requests and responses. Default: Last 1 Day
- **Top Allowed Applications** - Shows the total number of access instances for the top allowed applications within a specific period of time.
- **Top Threat Detection Count (default)** - Shows the total count of different threat types (Malicious URLs, Virus, Spyware, Botnet, Exploit) detected by IWSVA for a specified range of time to provide the high-level view of the risk level of various threat vectors. Default: Last 1 Day

- **Top Policy Enforcement - Application Control** - Shows which policies were violated by how many requests for a specified range of time to provide the effectiveness of policies and to identify needs to change. Defaults: Top 5, Last 1 Day
- **Top Policy Enforcement – URL Filtering** - Shows which policies were violated by how many requests for a specified range of time to provide the effectiveness of policies and to identify needs to change. Defaults: Top 5, Last 1 Day
- **Top Policy Enforcement - DLP** - Shows which policies violated (block/monitor) by how many requests for a specified range of time to provide the effectiveness of policies and to identify needs to change.
- **C&C Callback Attempts (Command-and-Control Callback Attempts)** - Shows C&C Callback Attempts noted within a specific period of time.

When mousing over the target component in the widget, corresponding numerical data-value displays. For example: when mousing over the Malicious-URLs bar on the “Total Threat Detection Count” widget, corresponding data-values are shown.

When clicking within a widget, the page is redirected to a log-analysis page that details the current widget setting parameters.

Web Traffic Security Risk Overview

Web traffic exposes corporate networks to many potential security risks. While most computer viruses enter organizations through messaging gateways, Web traffic is a common infection vector for new security risks. For example, “mixed risks,” which take advantage of multiple entry points and vulnerabilities using HTTP to spread.

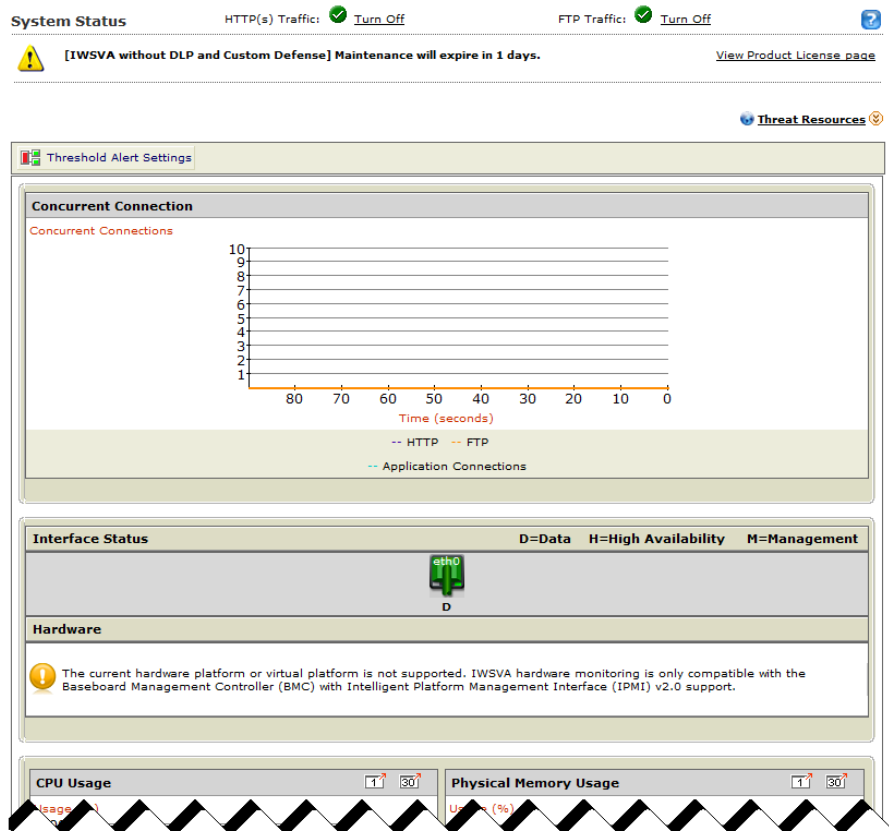

FIGURE 1-2. IWSVA System Status displays security risk information

Significant assessment, restoration, and lost productivity costs associated with outbreaks can be prevented. IWSVA is a comprehensive security product that identifies and protects multiple Internet protocols, including HTTPS, HTTP, and FTP traffic in enterprise networks from viruses and other risks.

In addition to content-based antivirus scanning, IWSVA also helps with other network security issues:

- The Application Control feature provides a security technology that automates the discovery of popular Internet applications and allows administrators to control them using policies.
- Monitor and enable block/allow policies for any of several hundred Internet applications that may be misused by employees.
- Web Reputation scrutinizes URLs before you access potentially dangerous Web sites, especially sites known to be phishing or pharming sites.
- URL filtering feature can allow, block, block with override, warn but allow, or monitor access to Web sites with content prohibited by your organization.
- HTTPS decryption feature allows encrypted traffic to pass through IWSVA scanning and filtering policies as “normal” HTTP traffic and verifies certificates from HTTPS servers.
- Applets and ActiveX security helps to reduce the risk of malicious mobile code by checking digital signatures at the HTTP/HTTPS gateway, and monitoring applets running on clients for prohibited operations. With Applets and ActiveX security modules and URL Filtering now included in the IWSVA, these come at no extra cost to you.

Smart Search Support

The search field above the left menu allows users to find the features they need quickly, without navigating through the menu.

To use the Smart Search function:

1. Go to any page in IWSVA Web console.
2. In the Smart Search search field above the left menu, begin to type the name of the feature to be located. (See [Figure 1-3](#).)
3. Select the appropriate feature from the options provided in the drop-down list.
4. Press **Enter**.

The page of your request feature displays.

Note: Smart Search is an instance-level feature. Passive nodes in High Availability environments will not be searched unless the administrator is logged into the passive member.

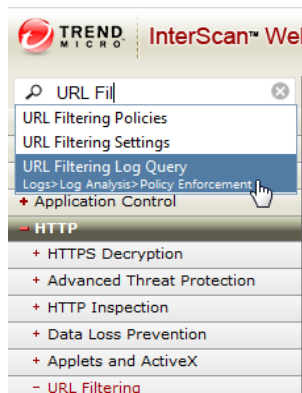

FIGURE 1-3. Smart Search available to find the location of features

Chapter 2

Deployment Wizard

The contents of this chapter help to guide you through the deployment process as you configure InterScan Web Security Virtual Appliance (IWSVA) for your network.

Topics in this chapter include the following:

- [Overview of the Deployment Wizard on page 2-2](#)
- [Mode Selection on page 2-2](#)
- [Mode-specific Settings on page 2-15](#)
- [Network Interface on page 2-26](#)
- [Static Routes on page 2-33](#)
- [Product Activation on page 2-34](#)
- [System Time Settings on page 2-38](#)
- [Results on page 2-39](#)
- [Post Deployment on page 2-39](#)

Overview of the Deployment Wizard

The Deployment Wizard display automatically at first login and will walk you through the deployment process. It can be manually invoked from **Administration > Deployment Wizard** at any time to review or change settings.

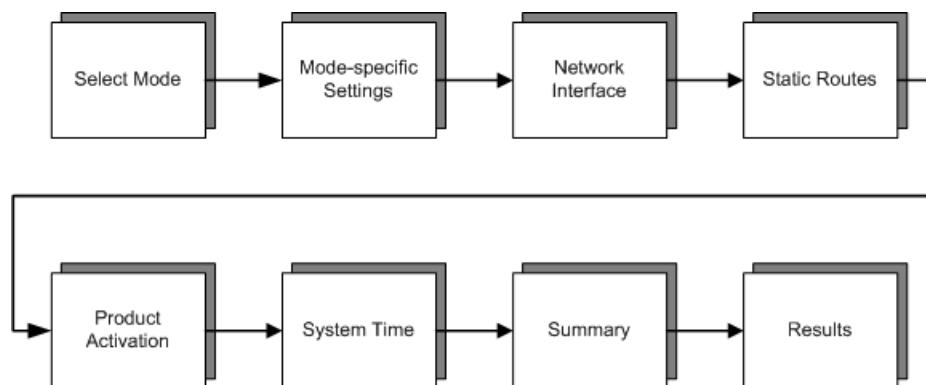

FIGURE 2-1. Deployment Wizard Flow

Mode Selection

IWSVA can be deployed in different modes, depending on your network security needs. For more information on which mode to select, see the Deployment Primer in Chapter 2 of the *IWSVA Installation Guide*.

The Deployment Wizard allows you to configure IWSVA in one of seven modes.

- [Transparent Bridge Mode on page 2-3](#)
- [Transparent Bridge Mode - High Availability on page 2-4](#)
- [Forward Proxy Mode on page 2-9](#)
- [Reverse Proxy Mode on page 2-10](#)
- [ICAP Mode on page 2-11](#)
- [Simple Transparency Mode on page 2-13](#)
- [Web Cache Coordination Protocol \(WCCP\) Mode on page 2-14](#)

Transparent Bridge Mode

IWSVA acts as a bridge between network devices such as routers and switches. IWSVA scans passing HTTP and FTP traffic without the need to modify browser or network settings. This is the easiest deployment mode with traffic scanned in both directions.

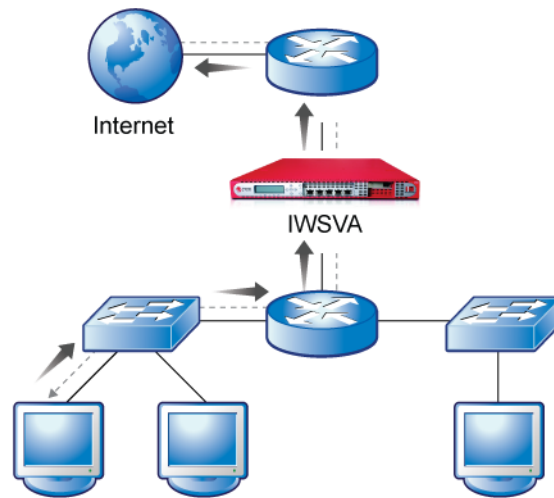

FIGURE 2-2. Transparent Bridge Mode

Transparent Bridge Mode and Transparent Bridge Mode - High Availability are also the only deployment modes that allow for the Application Control reporting and policies to function. For these reasons, Trend Micro strongly recommends deploying the product in one of these modes to realize maximum visibility and protection for Internet traffic.

The additional dependency for this deployment mode is two network interface cards per transparent bridge segment protected with IWSVA. Trend Micro recommends the following network cards be used to ensure maximum compatibility:

- Broadcom NetXtreme Series
- Intel Pro/1000 PT Dual Port Server Adapter
- Intel Pro/1000 MF Dual Port Fiber

Note: For more information on setting up IWSVA in Transparent Bridge mode, see [Network Configuration and Load Handling on page 6-11](#).

To deploy IWSVA in Transparent Bridge mode:

1. Go to **Administration > Deployment Wizard**.

Note: The Deployment Wizard launches automatically the first time an administrator logs in.

2. Click **Start** on the Welcome page.
3. Click the **Transparent Bridge Mode** radio button on the Deployment Mode page.
4. Click **Next**.
5. Go to [Network Interface on page 2-26](#) to continue.

Note: Transparent Bridge Mode for a single node requires no mode-specific settings. For more information on setting up IWSVA, see [Network Configuration and Load Handling on page 6-11](#).

To use a Silicom bypass card to do an ESX bypass:

1. Check www.silicom.com to obtain the necessary drivers and tools appropriate for your specific VMware ESXi version.
2. Disable IWSVA's built-in LAN-bypass function.
3. Use the Silicom-provided command line tools to control the LAN-bypass function.

Transparent Bridge Mode - High Availability

The IWSVA High Availability (HA) solution currently supports active/passive pairs utilizing the Transparent Bridge mode. To deploy an IWSVA cluster with an IPv4 or IPv6 address, each IWSVA unit must use a separate management interface.

The Transparent Bridge Mode - High Availability for HA deployment requires at least the four following network interfaces cards (NICs) for cluster deployment:

- Two for bridge data interfaces
- One for the HA interface
- One for the separate management interface

Note: For more information about high availability and cluster management, see [High Availability and Cluster Management for Transparent Bridge Mode](#) starting on page 3-1.

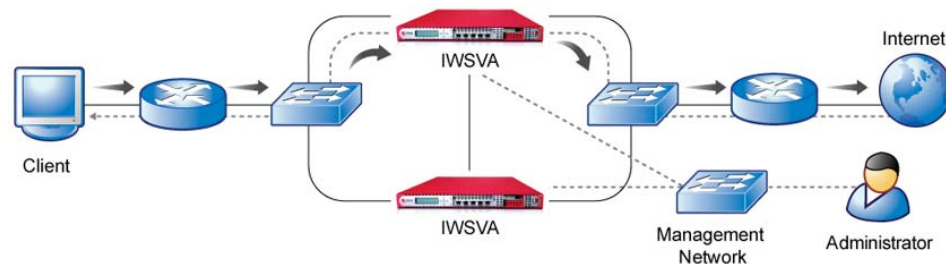

FIGURE 2-3. Transparent Bridge Mode - High Availability

Note: IWSVA only supports two HA nodes in a single HA cluster.

Using the Deployment Wizard, you can either:

- [Create a New Cluster on page 2-6](#)
- [Join an Existing Cluster on page 2-8](#)

About Cluster IP Addresses

The Cluster IP address is the floating IP address of the management port of the cluster. Users access this IP address through the Web console or the CLI to manage the cluster. The floating IP address floats in the cluster. If a switch over occurs, the floating IP address of cluster (the cluster IP address) always points to the parent device.

About Weighted Priority Election

Enabling Weighted Priority Election allows the device with the highest weight to always be selected as the parent member. Disabling the Weighted Priority Election process means the current parent member remains the parent member even when a new cluster member with a higher weight is added into the cluster.

The weight is the user-defined priority of the member in the cluster. If two members have the same weight assigned, there will still be one parent and one child, but the selection of the parent member is based on an internal algorithm. If you enable Weighted Priority Election, cluster members are prohibited from having equal weights.

Create a New Cluster

To create a new cluster:

1. Go to **Administration > Deployment Wizard**.

Note: The Deployment Wizard launches automatically the first time an administrator logs in.

2. Click **Start** on the Welcome page.
3. Click the **Transparent Bridge Mode - High Availability** option on the Deployment Mode page.
4. Click the **New Cluster** option.
5. Click **Next**.
6. Set the Cluster Settings, which include:
 - a. Type a cluster name.
 - b. Type an (optional) cluster description.
 - c. Type the Cluster IP address. See [About Cluster IP Addresses on page 2-5](#) for details.
 - d. Select Enable or Disable from the Weighted Priority Election drop-down list.

Note: For more information on Weighted Priority Election, see [About Weighted Priority Election on page 2-6](#).

Note: Cluster IP address does not support IPv6.

- If enabled, the HA pair launches an election to choose the maximum-weighted machine.
 - If disabled, the HA pair only launches an election when the current active (primary) machine is not available.
-

Note: The HA mode displays as Active/Passive and the Deployment mode always shows Bridge to indicate Transparent Bridge Mode - High Availability.

- e. Using the information in the Interface Status section, select the HA Interface from the drop-down list (eth0, eth1, eth2, eth3, etc.)

Active and passive IWSVAs are connected directly through the HA or “Heartbeat” interface. The interface, labeled H in the interface status graphic, has two functions:

- Active and passive virtual appliances send a package per second to notify each other they are up and running.
- The interface is used in the synchronization process.

See [Figure](#) on page 2-28 and [Table 2-2](#) on page 2-28 for more information on using the Interface Status graphic. Also see [Determining the Status of the Interfaces on page 2-27](#).

- f. Enter the Weight value. (Default 128)
- The member with the higher weighting has higher priority and becomes the parent member.
7. Click **Next**.
8. Set up the [Network Interface on page 2-26](#) to continue the deployment.

Join an Existing Cluster

To join an existing cluster:

1. Go to **Administration > Deployment Wizard**.

Note: The Deployment Wizard launches automatically the first time an administrator logs in.

2. Click **Start** on the Welcome page.
3. Click the **Transparent Bridge Mode - High Availability** option on the Deployment Mode page.
4. Click the **Join a Cluster** option.
5. Click **Next**.
6. Set the Cluster settings, which include:
 - a. Using the information in the Interface Status section, select the HA Interface from the drop-down list (eth0, eth1, eth2, eth3, etc.)

Active and passive IWSVAs are connected directly through the HA or “Heartbeat” interface. The interface, labeled H in the interface status graphic, has two functions:

 - Active and passive virtual appliances send a package per second to notify each other they are up and running.
 - The interface is used in the synchronization process.

See [Figure](#) on page 2-28 and [Table 2-2](#) on page 2-28 for more information on using the Interface Status graphic. Also see [Determining the Status of the Interfaces on page 2-27](#).
 - b. Enter the Weight value. (Default 64)
7. Click **Next**. A progress bar displays, showing connection to the existing cluster.
8. Review the cluster information page that displays after connecting to the cluster and click **Next**.
9. Set up the [Network Interface on page 2-26](#) to continue the deployment.

Forward Proxy Mode

IWSVA can act as an upstream proxy for network clients. Client browser settings must be configured to redirect traffic to IWSVA. IWSVA scans HTTP and FTP traffic and there is no separate need for another dedicated proxy server. Content is scanned in both the inbound and outbound directions. The Application Control reports and polices also function in the proxy mode because IWSVA recognizes the HTTP, HTTPS, and FTP protocols.

Forward Proxy Mode also provides the following additional capabilities:

- Forwards all traffic to another upstream proxy server
- Participates in a proxy chain configuration with other proxy servers and supports X-Forwarded-For functionality

Note: For more information on setting up IWSVA in Forward Proxy mode, see [Network Configuration and Load Handling](#) on page 6-11.

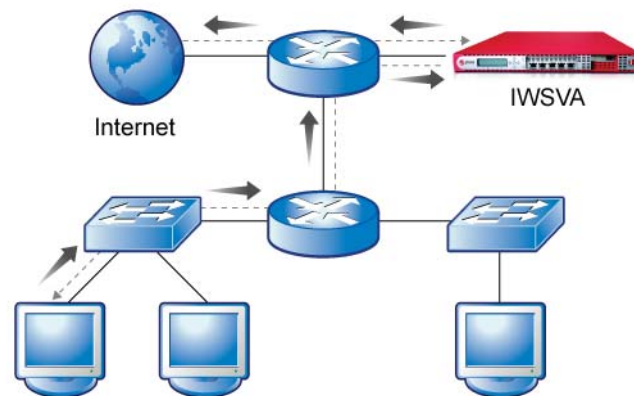

FIGURE 2-4. Forward Proxy Mode

To deploy IWSVA in Forward Proxy Mode:

1. Go to **Administration > Deployment Wizard**.

Note: The Deployment Wizard launches automatically the first time an administrator logs in.

2. Click **Start** on the Welcome page.
3. Click the **Forward Proxy Mode** radio button on the Deployment Mode page.
4. Click **Next**.
5. Go to [Mode-specific Settings on page 2-15](#) to continue.

Reverse Proxy Mode

In this deployment mode, IWSVA is deployed in front of a Web server. IWSVA scans HTTP and FTP content from the clients that are uploaded to a web server as well as content that is downloaded from the Web server to the clients and helps secure the Web server.

WARNING! The HTTPS decryption functionality along with the DLP functionality will be disabled in this mode.

Note: For more information on setting up IWSVA in Reverse Proxy mode, see [Network Configuration and Load Handling](#) on page 6-11.

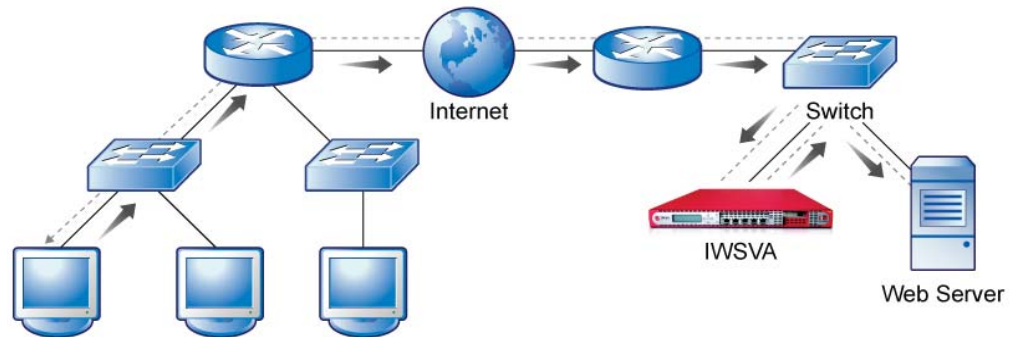

FIGURE 2-5. Reverse Proxy Mode

To deploy IWSVA in Reverse Proxy Mode:

1. Go to **Administration > Deployment Wizard**.

Note: The Deployment Wizard launches automatically the first time an administrator logs in.

2. Click **Start** on the Welcome page.
3. Click the **Reverse Proxy Mode** radio button on the Deployment Mode page.
4. Click **Next**.
5. Go to [Mode-specific Settings](#) on page 2-15 to continue.

ICAP Mode

IPv6 support is not currently provided for this deployment mode. In this deployment mode, IWSVA acts as an ICAP server and accepts ICAP connections from an ICAP v1.0 compliant cache server (acting as a client to IWSVA). Cache servers can help reduce

the overall bandwidth requirements and reduce latency by serving cached content locally. IWSVA scans and secure all content returned to the cache server and to the end-user clients.

Note: To enable and configure ICAP mode, see [Network Configuration and Load Handling on page 6-11](#) and [Setting Up IWSVA ICAP on page 2-43](#).

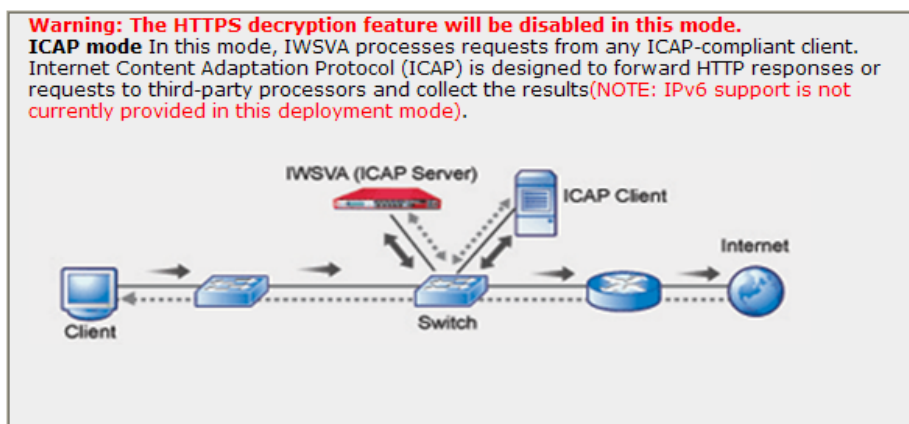

FIGURE 2-6. ICAP Mode

Deploying IWSVA in ICAP Mode in the Deployment Wizard

To deploy IWSVA in ICAP mode:

1. Go to **Administration > Deployment Wizard**.

Note: The Deployment Wizard launches automatically the first time an administrator logs in.

2. Click **Start** on the Welcome page.
3. Click the **ICAP Mode** radio button on the Deployment Mode page.
4. Click **Next**.
5. Go to [Mode-specific Settings on page 2-15](#) to continue.

Simple Transparency Mode

IPv6 support is not currently provided for this deployment mode. IWSVA's Forward Proxy Mode supports simple transparency with popular Layer 4 load balancing switches and provides HTTP scanning without the need to modify the client's browser settings. The HTTPS decryption feature is disabled in this mode.

Note: For more information on setting up IWSVA in Simple Transparency mode, see [Network Configuration and Load Handling on page 6-11](#).

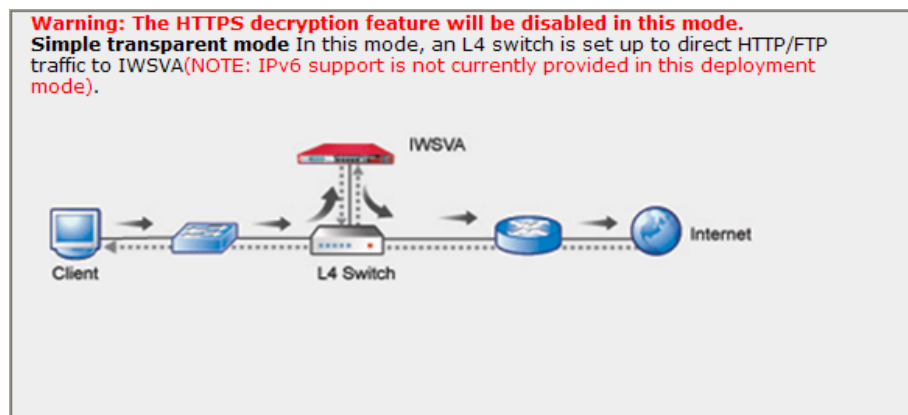

FIGURE 2-7. Simple Transparency Mode

To deploy IWSVA in Simple Transparency Mode:

1. Go to **Administration > Deployment Wizard**.

Note: The Deployment Wizard launches automatically the first time an administrator logs in.

2. Click **Start** on the Welcome page.
3. Click the **Simple Transparency Mode** radio button on the Deployment Mode page.
4. Click **Next**.
5. Go to [Mode-specific Settings on page 2-15](#) to continue.

Web Cache Coordination Protocol (WCCP) Mode

IPv6 support is provided for this deployment mode. IWSVA works with Cisco's WCCP protocol to provide content scanning for Web and FTP traffic without the need to modify client configurations and allows redundancy and scalability to be designed into the architecture without additional hardware.

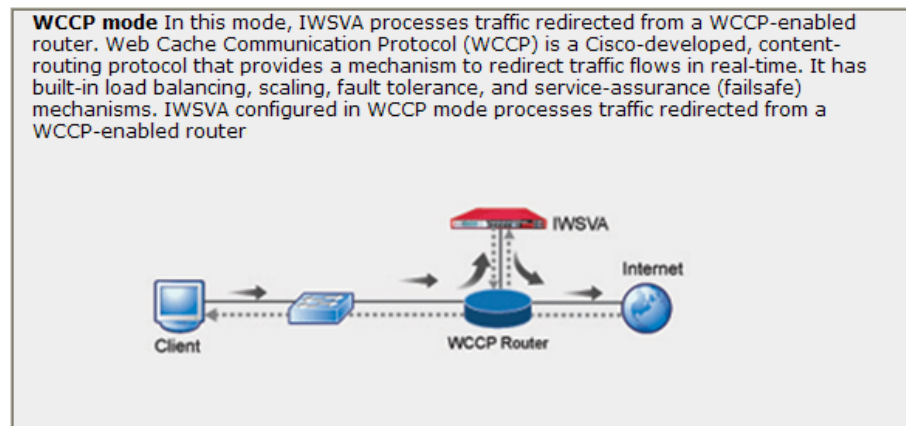

FIGURE 2-8. WCCP Mode

Note: For more information on setting up your WCCP server for use with IWSVA, see [Network Configuration and Load Handling on page 6-11](#) and your Cisco product documentation.

To deploy IWSVA in WCCP Mode:

1. Go to **Administration > Deployment Wizard**.

Note: The Deployment Wizard launches automatically the first time an administrator logs in.

2. Click **Start** on the Welcome page.
3. Click the **WCCP Mode** radio button on the Deployment Mode page.

4. Click **Next**.
5. Go to [Mode-specific Settings on page 2-15](#) to continue.

Mode-specific Settings

Some deployment modes have settings that are unique to that mode. The second step in the Deployment Wizard allows you to configure those settings. The Transparent Bridge Mode has no mode-specific settings.

TABLE 2-1. Mode-specific Settings

MODE	MODE-SPECIFIC SETTINGS	PAGE
Transparent Bridge	None	N/A
Transparent Bridge for HA	New: <ul style="list-style-type: none"> • Cluster settings • Weighted Priority Election (Y/N) • HA Interface • Weight Existing: <ul style="list-style-type: none"> • HA Interface • Weight 	New: 2-6 Existing: 2-8
Forward Proxy	Proxy settings	2-16
Reverse Proxy	Proxy settings	2-16
ICAP	ICAP settings	2-19
Simple Transparency	Transparency settings	2-21
WCCP	WCCP settings	2-22

Proxy Settings

Proxy settings must be configured if you are installing in the following modes:

- Forward Proxy, Standalone Mode - See [Standalone Proxy Mode Settings on page 2-16](#)
- Forward Proxy, Upstream Proxy Mode -See [Upstream Proxy \(Dependent\) Mode Settings on page 2-17](#)
- Reverse Proxy Mode - See [Reverse Proxy Settings on page 2-18](#)

Forward Proxy Mode

Depending on your network configuration, you can either specify:

- [Standalone Proxy Mode Settings on page 2-16](#)
- [Upstream Proxy \(Dependent\) Mode Settings on page 2-17](#)

Standalone Proxy Mode Settings

To configure the proxy settings for Standalone Mode:

1. Select the **Forward Proxy mode** radio button on the Deployment Mode page. See [Forward Proxy Mode on page 2-9](#) for details.
2. Click **Next**.
3. Follow the configuration recommendations in [Table 2-1](#).

TABLE 2-1. Standalone settings in Forward Proxy Mode

CONFIGURATION PARAMETER	DETAILS	RECOMMENDED VALUE
HTTP Listening port	This is the port that IWSVA listens on to receive connections.	8080
Enable upstream proxy (check box)	Enable / disable upstream proxy	Leave unchecked if you do not use another proxy device upstream of IWSVA.

TABLE 2-1. Standalone settings in Forward Proxy Mode (Continued)

CONFIGURATION PARAMETER	DETAILS	RECOMMENDED VALUE
Proxy server	The IP address of the preferred proxy server.	Enter either IPv4 or IPv6 addresses.
Port number	This is the port that IWSVA listens on to receive connections.	8080

4. Click **Next**.
5. Set up the [Network Interface on page 2-26](#) to continue the deployment.

Upstream Proxy (Dependent) Mode Settings

To configure the Proxy Settings for Upstream Mode:

1. Select the **Forward Proxy mode** radio button on the Deployment Mode page. See [Forward Proxy Mode on page 2-9](#) for details.
2. Click **Next**.
3. Follow the configuration recommendation in [Table 2-2](#).

TABLE 2-2. Upstream Proxy (Dependent) settings in Forward Proxy Mode

CONFIGURATION PARAMETER	DETAILS	RECOMMENDED VALUE
HTTP Listening port	This is the port that IWSVA listens on to receive connections	8080
Enable upstream proxy (check box)	Enable / Disable upstream proxy	Check (enable)
Proxy Server	IP address of the upstream proxy server	Type in the value of the upstream proxy server

TABLE 2-2. Upstream Proxy (Dependent) settings in Forward Proxy Mode (Continued)

CONFIGURATION PARAMETER	DETAILS	RECOMMENDED VALUE
Port	Port of the upstream proxy server	Type in the port number of the upstream proxy server

4. Click **Next**.
5. Set up the [Network Interface on page 2-26](#) to continue the deployment.

Reverse Proxy Settings

To configure the Proxy Settings for Reverse Proxy Mode:

1. Select the **Reverse Proxy mode** radio button from the Deployment Mode page. See [Reverse Proxy Mode on page 2-10](#) for details.
2. Click **Next**.
3. Follow the configuration recommendation in [Table 2-3/](#)

TABLE 2-3. Reverse Proxy Mode Proxy Settings

CONFIGURATION PARAMETER	DETAILS	RECOMMENDED VALUE
HTTP Listening port	This is the port that IWSVA listens on to receive connections for reverse proxy.	8080
Protected server	This is the IP address of the Web server IWSVA is protecting.	Type in the IP address of the protected server.
Port number	This is the port of the Web server IWSVA is protecting.	Type in the port number of the server being protected.

TABLE 2-3. Reverse Proxy Mode Proxy Settings (Continued)

CONFIGURATION PARAMETER	DETAILS	RECOMMENDED VALUE
SSL Port number	This is the SSL port of the Web server IWSVA is protecting.	Default is 80, the SSL port number of the server being protected.
Enable SSL Port (check box)	Enable / Disable SSL.	Leave disabled unless required. Check to enable.

4. Click **Next**.
5. Set up the [Network Interface on page 2-26](#) to continue the deployment.

ICAP Settings

Deploying in ICAP Mode requires addition configuration settings.

IWSVA can return four optional headers from the ICAP server whenever a virus is found or information about users and groups. These headers are not returned by default for performance reasons, because many ICAP clients do not use these headers. They must be enabled in the IWSVA Web console.

- **X-Virus-ID:** Contains one line of US-ASCII text with a name of the virus or risk encountered. For example:

```
X-Virus-ID: EICAR Test String
```

- **X-Infection-Found:** Returns a numeric code for the type of infection, the resolution, and the risk description.

For more details on the parameter values, see:

<http://www.icap-forum.org>

- **X-Authenticated - User:** If enabled, IWSVA requests the username sent in the X-Authenticated-User ICAP header. The username obtained from the ICAP header allows IWSVA to identify of the user issuing the request if you configure IWSVA to use the user/groupname method of user identification.

- **X-Authenticated - Group:** If enabled, IWSVA requests the group membership information sent in the X-Authenticated-Groups ICAP header if you configure IWSVA to use the user/groupname method of user identification. If disabled, IWSVA queries LDAP for the group membership information.

Note: Some ICAP clients do not offer the recursive group membership search. For example, if a user belongs to group A, and group A belongs to group B, the ICAP client only sends group A information in the header. If you require recursive group membership information, Trend Micro recommends disabling the x_authenticated_groups header.

To configure the ICAP settings:

1. Select the **ICAP mode** radio button from the Deployment Mode page of the Deployment Wizard.
See [ICAP Mode on page 2-11](#) for details.
2. Click **Next**.
3. Follow the configuration recommendations in [Table 2-4](#).

TABLE 2-4. ICAP Mode-specific Settings

CONFIGURATION PARAMETER	DETAILS	RECOMMENDED VALUE
HTTP Listening port	This is the port that IWSVA listens on to receive connections for ICAP.	1344
Enable X-Virus-ID ICAP header (check box)	Enable / Disable ICAP details about malware detected being recorded.	Disable
Enable X-Infection-Found ICAP header (check box)	Enable / Disable ICAP details about malware detected and passing details back to the ICAP device.	Disable

TABLE 2-4. ICAP Mode-specific Settings (Continued)

CONFIGURATION PARAMETER	DETAILS	RECOMMENDED VALUE
Enable X-Authenticated-User ICAP header	Enable / Disable ICAP details about username information.	Enable
Enable X-Authenticated-Groups ICAP Header	Enable / Disable ICAP details about group membership information.	Enable

4. Click **Next**.
5. Set up the [Network Interface on page 2-26](#) to continue the deployment.

Note: Complete all steps in the Deployment Wizard to deploy in ICAP mode. After receiving a successful deployment message, configure the IWSVA ICAP set up as shown in [Setting Up IWSVA ICAP](#) on page 2-43.

Simple Transparency Settings

Simple Transparency Mode requires mode-specific settings.

To configure mode-specific settings for Simple Transparency Mode:

1. Select the **Simple Transparency mode** radio button from the Deployment Mode page.
See [Simple Transparency Mode on page 2-13](#) for details.
2. Click **Next**.

3. Enter the following settings on the Simple Transparency Settings page. (See [Table 2-5](#).)

TABLE 2-5. Simple Transparency Mode-specific Settings

CONFIGURATION PARAMETER	DESCRIPTION	RECOMMENDED VALUE
HTTP Listening port	This is the port that IWSVA listens on to receive connections.	80
Anonymous FTP over HTTP	The email address passed to FTP sites.	Type in an appropriate email address

4. Click **Next**.
5. Set up the [Network Interface on page 2-26](#) to continue the deployment.

WCCP Settings

WCCP Mode requires mode-specific settings.

To configure mode-specific settings for WCCP Mode:

1. Select the **Web Cache Coordination Protocol (WCCP) mode** radio button from the Deployment Mode page.
See [Web Cache Coordination Protocol \(WCCP\) Mode on page 2-14](#) for details.
2. Click **Next**.
3. Enter the following settings on the WCCP Settings page. (See [Table 2-6](#).)

TABLE 2-6. WCCP Mode-specific Settings

CONFIGURATION PARAMETER	DETAILS	RECOMMENDED VALUE
HTTP Listening port	This is the port that IWSVA listens on to receive connections.	80

TABLE 2-6. WCCP Mode-specific Settings (Continued)

CONFIGURATION PARAMETER	DETAILS	RECOMMENDED VALUE
Router IP address	Detail which router or switch to communicate with via WCCP	Type in the router or switch IP address
Password	Password for WCCP authentication	Type in the password for the WCCP authentication
Auto-negotiate	Provides automatic negotiation of the forwarding method and the assignment method.	Select Enable (default.)
<p>Note: If you select Enable, the Forwarding and Assignment Methods parameters are grayed out since they are automatically configured. After the Deployment Wizard finishes, you can see the values of the auto-negotiated parameters at: Administration > Network Configuration > WCCP.</p> <ul style="list-style-type: none"> - If the route supports L2/GRE as a forwarding method, IWSVA should select L2 when the router and IWSVA are in the same network segment. (This takes performance into account.) - If one route supports L2/GRE as forwarding method, IWSVA should select GRE when the router and IWSVA are not in the same network segment. - If one route supports HASH/MASK as assignment method, IWSVA should select MASK. (This takes performance into account.) 		
WCCP forwarding method	The WCCP forwarding method determines how intercepted traffic is transmitted from the WCCP server (IOS) to the WCCP client.	Select the Generic Routing Encapsulation (GRE) or Layer 2 (L2) as the WCCP forwarding method

TABLE 2-6. WCCP Mode-specific Settings (Continued)

CONFIGURATION PARAMETER	DETAILS	RECOMMENDED VALUE
<p>Note: - GRE forwarding, which is the default forwarding method, encapsulates the intercepted packet in an IP GRE header with a source IP address of the WCCP server (IOS) and a destination IP address of the target WCCP client. This has the effect of a tunnel, allowing the WCCP server (IOS) to be multiple Layer 3 hops away from the WCCP client. - L2 forwarding simply rewrites the destination MAC address of the intercepted packet to equal the MAC address of the target WCCP client. L2 forwarding requires that the WCCP server (IOS) is Layer 2 adjacent to the WCCP client</p>		
<p>Assignment method</p>	<p>WCCP provides packet distribution through two algorithms, Hash tables and Mask/value sets.</p>	<p>Select Hash tables or Mask/value sets as the WCCP assignment method.</p>
<p>With hash assignment, the router runs a value in the header of the packet it is redirecting through a hashing function.</p> <p>With mask assignment, each router/switch in the service group has a table of masks and values that it uses to distribute traffic across the proxy appliances in the service group.</p>		

TABLE 2-6. WCCP Mode-specific Settings (Continued)

CONFIGURATION PARAMETER	DETAILS	RECOMMENDED VALUE
Service Group	Standard or Dynamic	<ul style="list-style-type: none"> • Standard—Well-known services, also referred to as static or standard services, have a fixed set of characteristics that are known by both IOS and WCCPv2 client devices. • Dynamic—Dynamic services are initially only known to the WCCPv2 clients within the service group.
<p>Note: For example, a single well-known (standard) service called web-cache has a Service ID is 0. This service redirects all TCP traffic with a destination port of 80.</p> <p>The characteristics of a dynamic service are initially only known to the WCCPv2 clients within the service group. The characteristics of the service group are communicated to the IOS devices by the first WCCPv2 client device to join the service group.</p>		
Unique Service ID	Identifies service groups Default: <ul style="list-style-type: none"> • Standard service = 0 • Dynamic service = 80 	Range: <ul style="list-style-type: none"> • Standard = 0-50 • Dynamic = 51-255
Anonymous FTP over HTTP	The email address passed to FTP sites.	Type in an appropriate email address

4. Click **Next**.
5. Set up the [Network Interface on page 2-26](#) to continue the deployment.

Network Interface

All modes need the relevant network interface settings configured. Some modes require slightly different information than other modes. The following procedures call out the different settings needed.

Network interface settings include:

- [Host Information on page 2-26](#)
- [Data Interface on page 2-29](#)
- [Separate Management Interface on page 2-31](#)
- [Miscellaneous Settings \(IPv4 and IPv6\) on page 2-32](#)

Host Information

All modes require the host information to be entered. Before starting this procedure, be sure you have:

- Selected your deployment mode
- Configured any mode-specific settings

To enter the host information:

1. Using the Deployment Wizard, select the appropriate deployment mode radio button and click **Next**.
2. Set any mode-specific settings and click **Next**.
3. Type the applicable Fully Qualified Domain name (FQDN) for the IWSVA host.

Note: A fully qualified hostname is required. Trend Micro recommends creating a DNS entry for the IWSVA server's hostname in their DNS server.

4. Continue to the section about the [Interface Status starting on page 2-27](#).

Interface Status

IWSVA provides a graphical representation of the physical Ethernet ports on the IWSVA server to simplify the configuration of the network ports. The Interface Status graphic shows the status and function of the available interfaces.

Use [Figure](#) on page 2-28 to interpret the status and function of the Ethernet ports used for configuration purposes in the Interface Status section.

Determining the Status of the Interfaces

IWSVA is a software virtual appliance that can be installed on all types of hardware. As such, the network information displayed in IWSVA's Web UI may not directly relate to the physical network interfaces installed in the server running IWSVA. For example, if the server came with two network interfaces installed on the motherboard and then an additional four-port Ethernet card was installed in the server to increase the network interfaces available, the IWSVA Web UI may display the first network port as Eth0 when it is actually mapped to physical network interface Eth2 on the new Ethernet card.

In order to positively identify the IWSVA Web UI network interface to the physical network interface, IWSVA provides a command line interface (CLI) command to display the real time status of the physical network interfaces and the Interface Status graphic in the Deployment Wizard.

By using the `show network interfaces status` CLI command from the IWSVA console, you can quickly see the link status of the physical interface. In the example below, you can see that Eth0 and Eth1 is up with a physical link connection.

```
enable# show network interfaces status

Network interface link status [press 'q' to quit]
  eth0: up
  eth1: up
  -
```





FIGURE 2-9. “show network interfaces status” CLI command



FIGURE 2-10. Interface Status

Figure 2-10 depicts the interface status information displays in the Deployment Wizard. *Table 2-2* defines the icons used in the interface status graphic.

TABLE 2-2. Interface Status Icons

CALLOUT	POINTS TO
M	Management interface
D	Data interface
H	HA or Heartbeat Interface
	Link not detected. Could be an empty port, cable may be loose or broken, or the peer machine may be down.
	Link ok
	Link error
	Link disabled

About Interface Mapping

Trend Micro recommends mapping the interfaces with physical interfaces before configuring or modifying your interface settings.

After rebooting IWSVA, the numbering for unused interfaces may change, however the occupied interfaces (for data, management, or HA) will not change.

Before dissolving a cluster, interfaces might be mapped as shown in [Table 2-7](#).

TABLE 2-7. Original Interface Mapping

PHYSICAL INTERFACE	A	B	C	D
RELATIVE INTERFACE	eth1	eth2	eth0	eth3
PURPOSE	D (internal)	H	D (external)	M

After dissolving a cluster, joining a cluster, or rebooting, the interface mapping might change as shown in [Table 2-8](#).

TABLE 2-8. Changed Interface Mapping

PHYSICAL INTERFACE	A	B	C	D
RELATIVE INTERFACE	eth2	eth1	eth0	eth3
PURPOSE	(internal)	(unused)	D (external)	M

Data Interface

The Data Interface supports end-user Internet traffic to and from the internal network. Use the following procedure to configure the host name and IP settings for the data (bridge or proxy) interfaces. You can use both IPv4 and IPv6 addresses.

WARNING! Do NOT configure the data interface and the management interface in the same network subnet. If they are in the same network segment, the IWSVA internal firewall will prevent proper forwarding of HTTP and FTP traffic.

Before starting this procedure, be sure you have:

- Selected your deployment mode
- Configured any mode-specific settings
- Configured the IWSVA host information

To configure the Data Interface settings:

1. Continue working from the **Network Interface** page of the Deployment Wizard.
2. Configure the Data Interface settings:
 - a. **All modes except Transparent Bridge mode:** Select the appropriate Ethernet port from the **Ethernet Interface** drop-down list for the data interface.
The dynamic Interface Status graphic displays your selection.
 - b. **Transparent Bridge Mode and Transparent Bridge Mode - High Availability only:** Select the appropriate Ethernet ports from the drop-down lists for the Internal and External interfaces.
The Interface Status graphic displays your selection.
 - c. Select the IP address type from the drop-down list:
 - **Static IP address** - to configure IP settings for the interface manually.
 - **Obtain from (DHCP)** - to have a DHCP server assign IP settings to the interface. (IPv6 addresses, gateways, and DNS can be obtained from DHCPv6.
 - d. Enter the IP address and Netmask.
 - e. Check the **Enable Ping** check box to allow the connection to be checked with the ping utility.
 - f. (Optional) **Transparent Bridge Mode and Transparent Bridge Mode - High Availability only:** Click the check box to enable the VLAN ID (1-4094)

Note: The HA parent unit and the HA child unit have separate, unique VLAN ID settings.

- g. Do one of the following:
 - Continue with the deployment mode settings, if you are setting up IWSVA for the first time or
 - Click **Next** and click through the remaining screens if you have already setup your deployment mode and are only modifying the data interface.
- 3. If needed, set up Data Interface access control list. See [Configuring Internet Access Control Settings on page 6-12](#).
- 4. Continue to the section about [Separate Management Interface starting on page 2-31](#).

Separate Management Interface

The separate management interface offers administrators an independent interface to log into the IWSVA device, either through the Web console or via SSH.

Enabling and disabling the separate management interface is done by setting the values and enabling them through the Network Settings page of the Deployment Wizard. You can use both IPv4 and IPv6 addresses.

Note: The separate management interface must be enabled for HA environments.

Before starting this procedure, be sure you have:

- Selected your deployment mode
- Configured any mode-specific settings
- Configured the IWSVA host information
- Configured the Data Interface information

To setup the separate management interface:

1. Continue working from the **Network Interface** page of the Deployment Wizard.
2. Check the check box for the **Enable Management Interface**.
3. Select an **Ethernet interface** from the drop-down list.

4. Enter a **Static IP address** for the management interface device.
5. Enter the **Netmask** for the management interface device.
6. Check the Enable Ping check box to allow the connection to be checked with the ping utility.
7. Do one of the following:
 - Continue with the deployment mode settings, if you are setting up IWSVA for the first time or
 - Click **Next** and click through the remaining screens if you have already setup your deployment mode and are just adding the separate management interface.

Miscellaneous Settings (IPv4 and IPv6)

The Miscellaneous Settings (IPv4 and IPv6) sections allow you to obtain the dynamic information from DHCP or enter static information for:

- Gateway IP addresses
- Primary DNS server IP addresses
- Secondary DNS server IP addresses

Before starting this procedure, be sure you have:

- Selected your deployment mode
- Configured any mode-specific settings
- Configured the IWSVA host information
- Configured data and management interface information

To configure the Miscellaneous settings:

1. Continue working from the **Network Interface** page of the Deployment Wizard.
2. Scroll to the **Miscellaneous Settings** section.

3. Do one of the following:
 - Check the **Obtain from DHCP** check box to have IWSVA obtain the dynamic Gateway, Primary, and Secondary DNS information OR
 - Type in the Gateway, Primary, and Secondary DNS information if it is static.

TABLE 2-9. Miscellaneous Settings information

PARAMETER	DESCRIPTION
Gateway	For static IP address configuration of the network device, type in the applicable (IPv4 or IPv6) IP address used as the gateway for this IWSVA installation.
Primary DNS	For static IP address configuration of the network device, type in the applicable IP address used as the primary DNS server for this IWSVA installation.
Secondary DNS	For static IP address configuration of the network device, type in the applicable IP address used as the secondary DNS server for this IWSVA installation.

4. Click **Next**.
5. Continue to the section on [Static Routes starting on page 2-33](#).

Static Routes

Static routes allow IWSVA to overcome problems routing traffic to and from network segments beyond the next router hop to which IWSVA connects. Static routes allow you to manually control the router connection used to send traffic to the Internet or back to the end users.

For example, if IWSVA updates patterns with an internal ActiveUpdate (AU) server through a different router, a static route should be added for AU server.

Note: If you bind a static route to an interface, the router port must be in the same network segment as the interface.

Before starting this procedure, be sure you have:

- Selected your deployment mode
- Configured any mode-specific settings
- Configured the network interface information

To configure settings for Static Routes:

1. From the Static Routes page in the Deployment Wizard, go to the Settings section and configure the following:
 - Network ID
 - Netmask
 - Router
 - Interface

Note: You can also add IPv6 routes into these static routes.

2. Click **Add to List**.
The static route displays in the Static Routes list.
3. Add additional static routes.
4. Click **Next**.
5. Continue to [Product Activation starting on page 2-34](#).

Product Activation

After completion of the registration process, performed during deployment, you must activate (or enable) your software. Trend Micro products do not scan traffic or enforce policy settings unless a valid Activation Code is entered.

To receive your Activation Code, you must enter your registration key with the Trend Micro Product Registration server.

To activate IWSVA:

1. Go to the Product Activation page in the Deployment Wizard.
2. Type the Activation Code for IWSVA.
3. Click **Next**.
4. Continue with *System Time Settings* on page 2-38.

About Licenses

A license to the Trend Micro software usually includes the right to product updates, pattern file updates, and basic technical support (“Maintenance”) for one (1) year from the date of purchase only. After the first year, Maintenance must be renewed on an annual basis according to Trend Micro’s Maintenance Fee pricing.

A Maintenance Agreement is a contract between your organization and Trend Micro, regarding your right to receive technical support and product updates in consideration for the payment of applicable fees. When you purchase a Trend Micro product, the License Agreement you receive with the product describes the terms of the Maintenance Agreement. The Maintenance Agreement expires but your License Agreement will not.

Note: The Maintenance Agreement expires but your License Agreement will not. If the Maintenance Agreement expires, your system will continue scanning, but you will not be able to update the virus pattern file, scan engine, or program files (even manually). Nor will you be entitled to receive technical support from Trend Micro.

Typically, ninety (90) days before the Maintenance Agreement expires, you will start to receive email notifications, alerting you of the upcoming discontinuation. You can update your Maintenance Agreement by purchasing renewal maintenance from your reseller, Trend Micro sales, or on the Trend Micro Online Registration URL:

<https://olr.trendmicro.com/registration/>

Third-party Licensing Agreements

Access third-party licensing agreements in the following directory:

`/usr/share/doc`

Registering Online

Registration must take place prior to activating the product.

There are several ways to register IWSVA:

- [To register if you are a new customer: on page 2-36](#)
- [To register if you are a registered user: on page 2-36](#)

To register if you are a new customer:

1. Click the **Trend Micro Product Registration Server** link in your product at **Administration > Product License**.
2. In the Enter Registration Key screen, use the Registration Key that came with your product (Trend Micro Enterprise Protection DVD or License Certificate).
3. Click **Continue**, and then **I CONFIRM**.

The Confirm Product Information screen appears.

4. Click **Continue with Registration** to confirm all the product information.
5. Next, type all the required contact information in the fields provided and click **Submit**.
6. From the Confirm Registration Information screen, click **Edit** to update your contact information and click **OK** to continue.

The Activation Code screen appears. Your Activation Code will be sent to your registered email address.

7. Click **OK** to finish.

To register if you are a registered user:

1. Click the **Trend Micro Product Registration Server** link in your product at **Administration > Product License**.
2. Type your Logon ID and password in the fields provided, and then click **Login**.
You will be prompted to change your password the first time you log on.
3. In the My Products screen, click **Add Products** and type the Registration Key.
4. To edit your company profile, click **View/Edit Company Profile**.
Your Activation Code appears on the next screen.
5. To receive a copy of your Activation Code at your registered email address, click **Send Now**.

Note: For maintenance renewal, contact Trend Micro sales or your reseller. Click Check Status Online at Administration > Product License to update the maintenance expiration date on the Product License screen manually.

About Activation Codes

An Activation Code is required to enable scanning and product updates. You can activate IWSVA during Setup or anytime thereafter. Register IWSVA during installation to receive an Activation Code.

Note: After registering IWSVA, you will receive an Activation Code via email. An Activation Code has 31 characters (including the hyphens) and looks like:

xx-xxxx-xxxxxx-xxxxxx-xxxxxx-xxxxxx-xxxxxx

A Registration Key has 22 characters (including the hyphens) and looks like:

xx-xxxx-xxxx-xxxx-xxxx

- You automatically receive an evaluation Activation Code if you download IWSVA from the Trend Micro Web site
- You can use a Registration Key to obtain an Activation Code online

You can find an evaluation Registration Key on the Trend Micro Enterprise Protection DVD. Use this key to obtain an Activation Code. You will get an evaluation Activation Code by email when you download IWSVA from the Web.

Before starting this procedure, be sure you have:

- Selected your deployment mode
- Configured any mode-specific settings
- Configured the network interface information
- Configured the static routes

To activate IWSVA:

1. Go to the **Product Activation** page in the Deployment Wizard.
2. Type the **Activation Code** for IWSVA.

3. Click **Next**.
4. Continue with [System Time Settings starting on page 2-38](#).

System Time Settings

System Time and Time Zone settings allow you to:

- Use the current system time
- Synchronize with your NTP server
- Enter the date and time manually
- Select your time zone

Before starting this procedure, be sure you have:

- Selected your deployment mode
- Configured any mode-specific settings
- Configured the network interface information
- Configured the static routes
- Entered product activation information

To set the system time and time zone settings:

1. Access the System Time page of the Deployment Wizard.
2. Select from one of the following options:
 - Current system time - keep the time already set on the system
 - Synchronize with NTP server (should support both IPv4 and IPv6 servers) -
 - Manually - Set the date and time manually
3. Set the appropriate time zone.
 - Select your continent from the drop-down list.
 - Select your city (or a city near you with the same time as your location) from the drop-down list.
4. Click **Next**.

Results

The results page will let you know if your settings were entered successfully and that IWSVA has been deployed. It will also indicate if your settings were not accepted.

The system checks deployment settings at the time of entry, before you move from one page in the Deployment Wizard to the next. Successful results are the most common outcome.

Deployment Status

This messages displays if your IWSVA deployment was successful with a status bar that reflects the on-going deployment your mode settings.

“Congratulations! Your appliance has been set up and deployed.”

You will be redirected to <IWSVA Web Console IP address> shortly. It may take several minutes for the system to implement the new configuration changes and to restart before allowing you to log in.”

Note: Trend Micro recommends you apply the latest software and/or OS updates for IWSVA as soon as you receive this message. For more information, see [Chapter 4 Updates starting on page 4-1](#).

Even if your deployment is successful, you could receive a message indicating a problem accessing the Web console. The message contains a suggestion on how to fix the problem. See the following example:

“You designated DHCP protocol to configure the IWSVA network interface, which prohibits the Deployment Wizard from finding the Web console IP address automatically. The IP address and port number can be obtained from the IWSVA server display.”

Post Deployment

After the Deployment Wizard is successfully configured, IWSVA automatically reboots. When rebooting the machine, the CLI shell login page should prompt all access addresses including the IPv4 and IPv6 URLs if you have configured an IPv6 address.

If you have configured an IPv6 address for IWSVA, you can access the Web console and CLI using the very IP address (IPv4 or IPv6 addresses) configured during the installation process. After IWSVA reboots, Trend Micro recommends you update IWSVA as soon as possible. See [Updates on page 4-1](#) for details.

Also:

- If you deployed in Transparent Bridge mode, see [LAN Bypass Function on page 2-40](#) for details on failopen NIC support.
- If you deployed in ICAP mode, see [Setting Up IWSVA ICAP on page 2-43](#) for details on setting up an ICAP-compliant cache server to work with IWSVA.
- See [Testing and Configuring IWSVA on page 15-1](#) for step-by-step processes to validate your installation.

LAN Bypass Function

The LAN bypass function allows the customer to install a Trend Micro supported fiber or Gigabit network interface card (NIC) into the supported server platform to allow the network traffic to be bypassed on specific error conditions.

Note: IWSVA only supports LAN bypass functionality in Transparent Bridge Mode.

Note: The IWSVA 6.0 Admin console contains a bypass button that allows users to bypass traffic manually without having the LAN-Bypass card in bridge mode.

Setup the by-pass function in one of three settings:

- **Auto**—Bypass is OFF when the system is in a normal state; Bypass mode is ON when system detects an abnormal state such as kernel panic issue or when power is cut off from the IWSVA unit
- **On**—Always bypass traffic
- **Off**—Never bypass traffic

Note: When the LAN bypass function is set to ON, the data interface is not available. However, the customer can still access IWSVA via the separate management interface, if configured.

The LAN bypass function supports two port Silicom cards:

- **SD:** PXG2BPFIL-SD, PXG2BPI-SD, PE2G4BPI35-SD
- **Non-SD:** PEG2BPFID, PEG2BPI

Enabling the LAN Bypass Function

The following procedure allows you to change the default settings for the LAN bypass feature. Change parameters when:

- Installing a new LAN bypass card
- Selecting NICs supporting LAN bypass for the data interface
- Changing the default LAN bypass mode

If you select one of the supported NICs that can perform hardware bypass in the Deployment Wizard, it will be enabled with the AUTO setting. Under the AUTO setting, the IWSVA monitors the critical services and OS kernel for crashes. If it detects an unrecoverable error, it will open the NIC into “fail open” or bypass mode.

Use the `show network lanbypass` command to check the LAN bypass status on IWSVA.

To display/enable/disable/change the LAN bypass service on the IWSVA unit:

1. Login to the CLI interface.
2. Execute one of the following commands in [Table 2-10](#).

TABLE 2-10. LAN Bypass CLI Commands

COMMAND	DESCRIPTION
<code>show network lanbypass</code>	Displays the current configuration status of LAN bypass function.

TABLE 2-10. LAN Bypass CLI Commands (Continued)

COMMAND	DESCRIPTION
<code>configure network lanbypass on</code>	Always bypasses traffic. After running this command, all traffic will be bypassed by LAN bypass card. Administrators may not be able to access the IWSVA device from the network data interface. The system will not adjust the LAN bypass status at any time.
<code>configure network lanbypass off</code>	Never bypasses traffic. The system will not adjust the LAN bypass status at any time.
<code>configure network lanbypass auto</code>	The system will auto-adjust the LAN bypass status. For example, when system starts and stops, the bypass will be turned off and turned on. When system is in an abnormal state (such as kernel panic), the bypass will be turned on. After recovery, the bypass will be turned off automatically.

The LAN bypass card configuration is saved at: `/etc/lanbypass.conf`. Migration updates the mapping table to import or export the LAN bypass configuration.

Note: The “ByPass Traffic” option allows an administrator to bypass traffic manually (without the LAN-Bypass card) in bridge mode.

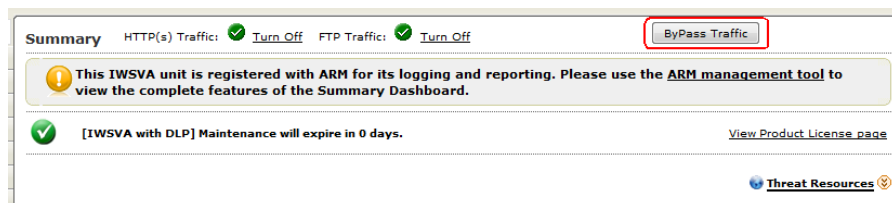
**FIGURE 2-11. ByPass Traffic Option**

Setting Up IWSVA ICAP

Perform these configuration steps if you are running IWSVA with an ICAP handler.

1. [Setting up an ICAP 1.0-compliant Cache Server on page 2-43](#)
2. [Flushing Existing Cached Content from the Appliance on page 2-50](#)

Note: The ICAP setup procedures below apply to the ICAP versions listed under [X-Authenticated ICAP Headers Support on page 1-14](#). They are provided for your convenience; consult the native documentation for complete information.

Setting up an ICAP 1.0-compliant Cache Server

Configure an ICAP client (for example, Network Appliance NetCache appliance/Blue Coat Port 80 Security Appliance cache server/Cisco ICAP server) to communicate with the ICAP server.

See the appropriate process for your ICAP client:

- [To set up ICAP for NetCache Appliance: on page 2-43](#)
- [To set up ICAP for the Blue Coat Port 80 Security Appliance: on page 2-45](#)
- [To set up Cisco CE ICAP servers: on page 2-48](#)

To set up ICAP for NetCache Appliance:

1. Log onto the NetCache console by opening `http://{SERVER-IP}:3132` in a browser window.
2. Click the **Setup** tab, then click **ICAP > ICAP 1.0** on the left menu.
3. Click the **General** tab, then select **Enable ICAP Version 1.0**.
4. Click **Commit Changes**.

Note: An error message “icap: This service is not licensed.” appears if you have not provided the required ICAP license key for NetCache.

5. Enter an ICAP license key:
 - a. Click the **Setup** tab, and then click **System > Licenses** in the left menu. The **System Licenses** screen opens.
 - b. Type your license under the **ICAP license** section.
 - c. Click **Commit Changes**.
6. Select the **Service Farms** tab on the **ICAP 1.0** screen, then click **New Service Farm** to add ICAP servers. Assign the service farm name in the **Service Farm Name** field.
 - For response mode, select **RESPMOD_PRECACHE** in the **Vectoring Point** field.
 - For request mode, select **REQMOD_PRECACHE** in the **Vectoring Point** field.
7. Select **Service Farm Enable**.
8. In the **Load Balancing** field, choose the proper algorithm to use for load balancing (if you have more than one ICAP server in the service farm). Clear **Bypass on Failure**.

Note: Disable **Bypass on Failure** if your priority is to limit virus propagation within your network. Otherwise, enable **Bypass on Failure** to guarantee an unblocked connection to the Internet.

9. Under the **Consistency** field, choose **strong** from the drop-down menu and leave the **lbw Threshold** field empty.

Note: For multiple ICAP servers within a service farm with **strong** consistency selected, make sure that all ICAP servers have identical `intscan.ini` and other configuration files and the same virus pattern. The service farm will not work properly if the ICAP servers have different configurations.

10. Under the **Services** text box (for response mode), type:
`icap://{ICAP-SERVER-IP}:1344/RESP-Service` on
where `ICAP-SERVER-IP` is the IP address of IWSVA ICAP for response mode.

-
- a. For multiple IWSVA ICAP server services, type the additional entries for response mode:
icap://{ICAP-SERVER1-IP}:1344/resp on
icap://{ICAP-SERVER2-IP}:1344/resp on
 11. Under the **Services** text box (for request mode), type
icap://{ICAP-SERVER-IP}:1344/REQ-Service on
where ICAP-SERVER-IP is the IP address of IWSVA ICAP for request mode.
 - a. For multiple IWSVA ICAP server services, type the additional entries for request mode:
icap://{ICAP-SERVER1-IP}:1344/REQ-Service on
icap://{ICAP-SERVER2-IP}:1344/REQ-Service on
 12. Click **Commit Changes**.
 13. Click the **Access Control Lists** tab, then select **Enable Access Control Lists**.
 14. Type “icap (Service Farm name of the ICAP Server) any” in **HTTP ACL**.
 15. Click **Commit Changes**.
 16. To configure scanning FTP over HTTP traffic, go to **Access Control List** and add “icap (service farm name)” into the **FTP ACL** field.

To set up ICAP for the Blue Coat Port 80 Security Appliance:

1. Log onto the Web console by typing `https://{SERVER-IP}:8082` in the address bar of your Web browser.

Note: The procedure for setting up ICAP on a Blue Coat appliance might vary depending on the product version.

2. Select **Management**.
Type the logon user name and password, if prompted.
3. Click **ICAP** in the left menu, then click the **ICAP Services** tab.
4. Click **New**.
The **Add ICAP Service** screen opens.
5. In the **ICAP service name** field, type an alphanumeric name. Click **Ok**.

6. Highlight the new ICAP service name and click **Edit**.
The **Edit ICAP Service name** screen opens.
7. Type or select the following information:
 - a. The ICAP version number (that is, 1.0)
 - b. The service URL, which includes the virus-scanning server host name or IP address, and the ICAP port number. The default ICAP port number is 1344.
 - Response mode:
`icap://{ICAP-SERVER-IP}:1344`
 - Request mode:
`icap://{ICAP-SERVER-IP}:1344/REQ-Service`
where `ICAP-SERVER-IP` is the IP address of IWSVA ICAP.
 - c. The maximum number of connections (ranges from 1-65535). The default value is 5.
 - d. The connection time-out, which is the number of seconds the Blue Coat Port 80 Security Appliance waits for replies from the virus-scanning server. The range is an interval from 60 to 65535. The default time-out is 70 seconds.
 - e. Choose the type of method supported (response or request modes).
 - f. Use the default preview size (bytes) of zero (0).
 - g. Click **Sense settings** to retrieve settings from the ICAP server (recommended).
 - h. To register the ICAP service for health checks, click **Register** under the **Health Check Options** section.
8. Click **Ok**, then click **Apply**.

Note: You can edit the configured ICAP services. To edit a server configuration again, select the service and click **Edit**.

9. Add the response or request mode policy.
The Visual Policy Manager requires the Java 2 Runtime Environment Standard Edition v.1.3.1 or later (also known as the Java Runtime or JRE) from Sun™ Microsystems, Inc. If you already have JRE on your workstation, the Security

Gateway opens a separate browser window and starts the Visual Policy Manager. The first time you start the policy editor, it displays an empty policy.

If you do not have JRE on your workstation, a security warning window opens. Click **Yes** to continue. Follow the instructions.

To add the response mode policy:

1. Select **Management**.
Type the logon user name and password if prompted.
2. Click **Policy** on the left menu, then click the **Visual Policy Manager** tab.
3. Click **Start**. If the **Java Plug-in Security Warning** screen appears, click **Grant this session**.
4. On the menu bar, click **Edit > Add Web Content Policy**. The **Add New Policy Table** screen opens.
5. Type the policy name under the **Select policy table name** field. Click **OK**.
6. Under the **Action** column, right-click **Bypass ICAP Response Service** and click **Set**. The **Add Object** screen opens. Click **New** and select **Use ICAP Response Service**. The **Add ICAP Service Action** screen opens.
7. Choose the ICAP service name under the **ICAP Service/Cluster Names** field. Enable **Deny the request** under the **On communication error with ICAP service** section. Click **OK**, then click **OK** again.
8. Click **Install Policies**.

To add the request mode policy:

1. Follow Step 1 through Step 5 in the previous procedure.
2. Under the **Action** column, right-click **Deny** and click **Set**. The **Add Object** screen opens. Click **New** and select **Use ICAP Request Service**. The **Add ICAP Service Action** screen opens.
3. Choose the ICAP service name under the **ICAP Service/Cluster Names** field.
4. Enable **Deny the request** under the **On communication error with ICAP service** section.
5. Click **OK** and then **OK** again.
6. Click **Install Policies**.
7. Configure both the request and response mode ICAP services.

To check the current policy, go to the Policy screen, click the **Policy Files** tab, and then click **Current Policy**.

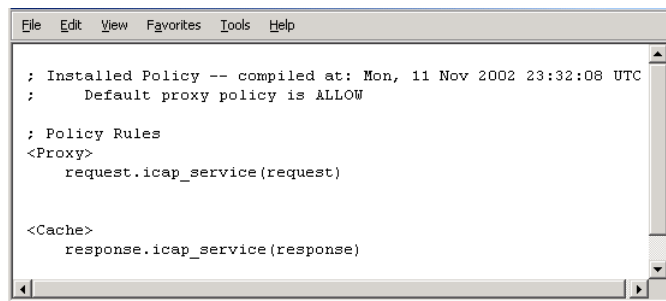

```

File Edit View Favorites Tools Help
; Installed Policy -- compiled at: Mon, 11 Nov 2002 23:32:08 UTC
;   Default proxy policy is ALLOW

; Policy Rules
<Proxy>
  request.icap_service(request)

<Cache>
  response.icap_service(response)

```

FIGURE 2-12. Install Policies screen

To set up Cisco CE ICAP servers:

IWSVA supports Cisco ICAP servers (CE version 5.1.3, b15). All ICAP settings are performed through a command line interface (CLI); there is no user interface associated with the Cisco ICAP implementation.

1. Open the Cisco CE console.
2. Type **config** to enter the configuration mode.
3. Type **icap?** to display a list of all ICAP-related commands.
4. Create a response modification service, by typing:

```
icap service RESPMOD SERVICE NAME
```

This takes you into the ICAP service configuration menu. Type **?** to display a list of all available commands. Type the following commands:

```
server icap://ICAP SERVER IP:1344/resp (to assign a server type)
```

```
vector-point respmod-precache (to assign the proper vector point type)
```

```
error-handling return-error (to assign the proper error-handling type)
```

```
enable (to enable the ICAP multiple server configuration)
```

5. Type **exit**.
 6. Create a request modification service, by typing
- ```
icap service REQUESTMOD SERVICE NAME
```

This command takes you into the ICAP service configuration menu. Type **?** to display a list of all available commands. Issue the following commands:

```
server icap://ICAP SERVER IP:1344/REQ-Service (to assign a server type)
vector-point reqmod-precache (to assign the proper vector point type)
error-handling return-error (to assign the proper error-handling type)
enable (to enable the ICAP multiple server configuration)
```

7. Type **exit**.
8. For additional configuration steps, type the following:

```
icap append-x-headers x-client-ip (to enable X-client headers for reports)
icap append-x-headers x-server-ip (to enable X-server headers for reports)
icap rescan-cache IStag-change (to turn on IStag rescan for updates)
icap bypass streaming-media (to exclude streaming media from ICAP scanning)
icap apply all (to apply all settings and activate ICAP type)
show icap (to display current ICAP configuration at root CLI menu)
```

## Configuring Virus-scanning Server Clusters

For the Blue Coat Port 80 Security Appliance to work with multiple virus-scanning servers, configure a cluster in the Security Gateway (add the cluster, and then add the relevant ICAP services to the cluster).

### To configure a cluster using the Web console:

1. Select **Management**.  
Type the logon user name and password if prompted.
2. Click **ICAP** on the left menu, then click the **ICAP Clusters** tab.
3. Click **New**.  
The **Add ICAP Cluster** screen opens.
4. In the **ICAP cluster name** field, type an alphanumeric name and click **Ok**.
5. Highlight the new ICAP cluster name and click **Edit**.  
The **Edit ICAP Cluster name** screen opens.
6. Click **New** to add an ICAP service to the cluster.

The **Add ICAP Cluster Entry** screen opens. The pick list contains a list of any services available to add to the cluster.

7. Choose a service and click **Ok**.
8. Highlight the ICAP cluster entry and click **Edit**.  
The **Edit ICAP Cluster Entry name** screen opens.
9. In the **ICAP cluster entry weight** field, assign a weight from 0-255.
10. Click **Ok**, click **Ok** again, and then click **Apply**.

## Deleting a Cluster Configuration or Entry

You can delete the configuration for an entire virus-scanning server cluster, or you can delete individual entries from a cluster.

---

**Note:** Do not delete a cluster used in a Blue Coat Port 80 Security Appliance policy if a policy rule uses a cluster name.

---

### To delete a cluster configuration using the Web console:

1. Select **Management**.  
Type the logon user name and password if prompted.
2. Click **ICAP** on the left menu, then click the **ICAP Clusters** tab.
3. Click the cluster you want to delete.
4. Click **Delete**, then click **Ok** to confirm.

## Flushing Existing Cached Content from the Appliance

There is a potential risk of infection from content cached to the NetCache appliance, Blue Coat Port 80 Security Appliance, or the Cisco ICAP servers before IWSVA ICAP started scanning HTTP traffic. To safeguard against this possibility, Trend Micro recommends flushing the cache immediately after configuring IWSVA ICAP. All new requests for Web content are then served from the Internet and scanned by IWSVA ICAP before caching. Scanned content is then cached on the NetCache appliance, Blue Coat Port 80 Security Appliance, or the Cisco ICAP servers. The NetCache appliance,

the Blue Coat Port 80 Security Appliance, or the Cisco ICAP servers serve future requests for the same Web content by your network users. Because the request is not sent to the Internet, download time is accelerated.

**To flush the cache in NetCache:**

1. Click the **Utilities** tab, then click **Cache Objects** on the left menu.
2. Click **Flush** under the **Flush the Cache** section.

**To flush the cache in the Blue Coat Port 80 Security Appliance:**

1. Select **Management**.  
Type the logon user name and password if prompted.
2. Click **Maintenance**.
3. Click the **Tasks** tab and click **Clear**. Click **OK** to confirm.

**To flush the cache in the Cisco ICAP server:**

1. Telnet to Cisco CE.
2. At the root CLI menu, type **cache clear**.
3. Press **Enter**.

## Verifying that InterScan Web Security Virtual Appliance is Listening for ICAP Requests

To verify that IWSVA is listening on the correct port, use PuTTY to access IWSVA via SSH as the “admin” user.

After logging in as the “admin” user, issue the CLI command `show network connections all` CLI command to show all active network connections through IWSVA. There should now be a TCP port access available on port **1344**.

Sample of command and output:

```
enable# show network connections all
Active Internet connections (servers and established)
Proto Recv-Q Send-Q Local Address Foreign Address
State
tcp 0 0 0.0.0.0:9091 0.0.0.0:* LISTEN
tcp 0 0 127.0.0.1:8005 0.0.0.0:* LISTEN
tcp 0 0 0.0.0.0:1812 0.0.0.0:* LISTEN
tcp 0 0 0.0.0.0:22 0.0.0.0:* LISTEN
tcp 0 0 0.0.0.0:5432 0.0.0.0:* LISTEN
```

```

tcp 0 0 10.204.170.156:22 10.204.170.158:2665
ESTABLISHED
udp 0 0 0.0.0.0:514 0.0.0.0:*
udp 0 0 0.0.0.0:21273 0.0.0.0:*
udp 0 0 0.0.0.0:35739 0.0.0.0:*
udp 0 0 0.0.0.0:7068 0.0.0.0:*
udp 0 0 0.0.0.0:17437 0.0.0.0:*
udp 0 0 0.0.0.0:22688 0.0.0.0:*
udp 0 0 0.0.0.0:9911 0.0.0.0:*
udp 0 0 0.0.0.0:30138 0.0.0.0:*
udp 0 0 0.0.0.0:60733 0.0.0.0:*
udp 0 0 0 127.0.0.1:9925 127.0.0.1:9925
ESTABLISHED
udp 0 0 0.0.0.0:36946 0.0.0.0:*
udp 0 0 0.0.0.0:41560 0.0.0.0:*
udp 0 0 0.0.0.0:29294 0.0.0.0:*
udp 0 0 0.0.0.0:12655 0.0.0.0:*
udp 0 0 0.0.0.0:38390 0.0.0.0:*
udp 0 0 0.0.0.0:7036 0.0.0.0:*

```

## Active UNIX domain sockets (servers and established)

| Proto | RefCnt | Flags   | Type   | State     | I-Node  | Path                             |
|-------|--------|---------|--------|-----------|---------|----------------------------------|
| unix  | 2      | [ ACC ] | STREAM | LISTENING | 6643358 | /tmp/ssh-ddgvf12499/agent.12499  |
| unix  | 2      | [ ACC ] | STREAM | LISTENING | 634599  | /var/run/nscd/socket             |
| unix  | 2      | [ ACC ] | STREAM | LISTENING | 7249    | /var/run/dbus/system_bus_socket  |
| unix  | 2      | [ ACC ] | STREAM | LISTENING | 7368    | @/var/run/hald/dbus-uIGJbIMMam   |
| unix  | 2      | [ ]     | DGRAM  |           | 6421523 | /tmp/tmsyslog                    |
| unix  | 2      | [ ]     | DGRAM  |           | 6421525 | /tmp/log                         |
| unix  | 2      | [ ACC ] | STREAM | LISTENING | 3065236 | /tmp/.s.PGSQL.5432               |
| unix  | 2      | [ ]     | DGRAM  |           | 1274    | @/org/kernel/udev/udev           |
| unix  | 2      | [ ]     | DGRAM  |           | 7379    | @/org/freedesktop/hal/udev_event |
| unix  | 2      | [ ACC ] | STREAM | LISTENING | 7369    | @/var/run/hald/dbus-0oDgnh6zwa   |
| unix  | 5      | [ ]     | DGRAM  |           | 6430159 | /dev/log                         |
| unix  | 2      | [ ]     | DGRAM  |           | 6643350 |                                  |
| unix  | 2      | [ ]     | DGRAM  |           | 6603791 |                                  |
| unix  | 2      | [ ]     | DGRAM  |           | 6430163 |                                  |
| unix  | 2      | [ ]     | DGRAM  |           | 065234  |                                  |
| unix  | 3      | [ ]     | STREAM | CONNECTED | 8017    | /var/run/dbus/system_bus_socket  |
| unix  | 3      | [ ]     | STREAM | CONNECTED | 8016    |                                  |
| unix  | 3      | [ ]     | STREAM | CONNECTED | 8003    | @/var/run/hald/dbus-uIGJbIMMam   |
| unix  | 3      | [ ]     | STREAM | CONNECTED | 8002    |                                  |
| unix  | 3      | [ ]     | STREAM | CONNECTED | 7872    | @/var/run/hald/dbus-uIGJbIMMam   |
| unix  | 3      | [ ]     | STREAM | CONNECTED | 7870    |                                  |



```
unix 3 [] STREAM CONNECTED 7835 @/var/run/hald/dbus-uIGJbIMMam
unix 3 [] STREAM CONNECTED 7834
unix 3 [] STREAM CONNECTED 7372 @/var/run/hald/dbus-0oDgnh6zwa
unix 3 [] STREAM CONNECTED 7371
unix 3 [] STREAM CONNECTED 7257
unix 3 [] STREAM CONNECTED 7256
enable#
```

## Understanding the Differences between Request Mode and Response Mode

**ICAP Request Mode:** When a new request is received, the request is sent to the scanning server to ensure it is a valid access request.

**ICAP Response Mode:** When the new request is valid, any returned content is scanned.

It is possible to use only one scanning vector; however, this reduces the ability to scan all appropriate traffic by 50%.

### Triggering a Request Mode Action

The steps outlined below are specifically for the triggering of a request mode action through IWSVA:

1. Log into a client that is passes traffic through IWSVA.
2. Open a Web browser and open the site [www.goodclup.com/caiink/t1.exe](http://www.goodclup.com/caiink/t1.exe)

The outbound URL is passed to InterScan Web Security Suite and is blocked. Damage Cleanup Services is still configured to perform an automatic cleanup, the workstation also has an automatic remediation attempt performed against it.

### Triggering a Response Mode Action

The steps outlined below are specifically for the triggering of a response mode action through IWSVA.

1. Log into a client that is passes traffic through IWSVA.
2. Open a Web browser and open the site [www.eicar.org](http://www.eicar.org).
3. Click on the button labeled **AntiMalware Testfile**.

4. Scroll to the bottom of the page where it details **Download area using the standard protocol http**.
5. Select the **eicar.com.txt** file to download.

The outbound URL is valid, thus the request mode allowed the URL to pass. The response of the traffic — the actual download triggers InterScan Web Security to block the download from occurring.

# Chapter 3

## High Availability and Cluster Management for Transparent Bridge Mode

This chapter discusses how High Availability functions in Transparent Bridge mode and how to use the Cluster Management interface.

Topics in this chapter include the following:

- [High Availability Overview on page 3-2](#)
- [HA Agent and Interfaces on page 3-4](#)
- [About Cluster Management on page 3-10](#)

## High Availability Overview

IWSVA provides native High Availability (HA) to ensure business continuity using active/passive pairs deployed in Transparent Bridge mode.

---

**Note:** The IWSVA HA solution currently only supports active/passive pairs in “Transparent Bridge mode” for High Availability. It only supports two HA nodes in one HA cluster. Redundancy among multiple IWSVAs deployed in the other supported deployment modes is handled externally to the IWSVA. Specifically, load balancers support redundancy in any of the proxy modes. The Cisco WCCP device can manage traffic to redundant IWSVAs in WCCP mode. The ICAP client can manage traffic to redundant IWSVAs in ICAP mode.

---

The four terms to describe HA cluster members are:

- **Active member**—The IWSVA unit providing real-time content scanning.
- **Passive member**—The IWSVA unit in passive standby mode.
- **Parent member**—The IWSVA unit responsible for accepting all configuration changes and synchronizing the policy and configuration with the child member.
- **Child member**—The IWSVA unit that is receiving the policy and configuration changes in the background.

HA switchover can be automatic (failover) or manual.

For failover:

- IWSVA's HA service monitors the critical services of the IWSVA application and the underlying OS for failures. If an abnormality occurs on the active unit, the HA service switches from the active node to the passive node automatically.
- Some of the administrator's HA management operations—like joining of a node or the shutdown of the parent—can trigger an automatic switchover. HA handles this type of switchover gracefully and automatically.

For manual switchover:

- Administrators can manually force an HA switch over using the Web console on the parent node.

- 
- Note:**
- 1) HA disables the LAN By-pass feature. It is not required with HA.
  - 2) HA requires the enabling of the Spanning Tree Protocol (STP). This prevents the creation of Layer 2 loops in the network.
  - 3) If the switch used by the HA solution supports Rapid Spanning Tree Protocol (RSTP), then this requires that STP be disabled on the IWSVA to provide faster switching.
  - 4) Enabling STP/RSTP requires disabling the PortFast Bridge Protocol Data Unit (BPDU) guard on both switches because BPDU disables the ports on the switches and prevents HA from functioning.
- 

## About Active/Passive Pairs

The active/passive pair can be connected directly together or through a dedicated switch. The active/passive pair requires two private IP addresses and a private reserved subnet for proper configuration. These private IP addresses are reserved for the HA function's internal use and are used for HA heartbeat information and data synchronization. No user devices are allowed on this private subnet.

IWSVA uses a cluster IP address for the active/passive pair, which is used for managing the HA cluster. This cluster management IP address floats between the two HA units and is always associated with the active member of the HA pair.

The active node scans HTTP, HTTPS, and FTP traffic. The passive node works as stand-by device which does not scan traffic in normal conditions. The passive node can become the active node if an abnormal condition occurs in the active node, such as:

- Data link failure
- OS kernel panic
- Critical services of the IWSVA application fail

IWSVA triggers a failover when the active unit goes down, whether it is caused by a heartbeat down, application down, or system down condition. When a failed unit is brought back online, a user-defined policy determines which unit becomes the newly elected active unit. Administrators can configure the election policy to allow the passive unit to remain as the active unit (normal mode), or configure the election policy with node weighting to always allow a specific HA member to regain control as the active unit.

## The HA Agent Handles Status Changes

The IWSVA device that joins the cluster as the first member becomes the active parent node by default.

If the Weighted Priority Election feature is not enabled, the second IWSVA device that joins an existing cluster becomes the passive child node by default.

If the Weighted Priority Election feature is enabled, and a second IWSVA device joins an existing cluster with a higher weighting than the first cluster member, that higher weighted, second machine becomes the active parent member and the original member becomes the passive child member.

## Failover vs. Switchover

Failover occurs when the active node crashes or fails to handle traffic normally. IWSVA automatically switches over to the passive standby machine in the cluster and elects the new machine to be the active member.

Switchover occurs when a manual role change is forced through the parent's web management interface—allowing the original child/passive unit to become the new parent/active unit.

## HA Agent and Interfaces

The HA Agent can be configured with the following management features:

- [About the Deployment Wizard on page 3-4](#)
- [About the Application Health Monitor on page 3-5](#)
- [About Central Management on page 3-6](#)
- [About Cluster Management on page 3-10](#)

## About the Deployment Wizard

Use the Deployment Wizard to access the following operations:

- [Creating a Cluster on page 3-5](#)
- [Joining a Cluster on page 3-5](#)

---

**Note:** For more about using the Deployment Wizard, see Chapter 2, *Deployment Wizard*.

---

## Creating a Cluster

A new HA cluster is created through the Deployment Wizard interface. When a new HA cluster is created, the management system configures the HA Agent with the desired policy settings and stores it on the parent member. Parent members are the only units that can be actively configured. A child member receives regular updates from the parent member to stay synchronized with the latest configuration and policy information. See step-by-step instructions for creating a cluster at [Create a New Cluster on page 2-6](#).

---

**Note:** HA Cluster IP's do not support IPv6 addresses.

---

## Joining a Cluster

When HA members are added to the HA cluster, the Deployment Wizard captures and configures each member with the appropriate network and weight information to setup the parent and child members.

The member with the higher weighting becomes the parent member. This allows you to manually elect the machine that will become the primary active unit.

The HA Agent is responsible for synchronizing the information between the cluster members and for initiating the failover or switchover.

See step-by-step details at [Join an Existing Cluster on page 2-8](#).

## About the Application Health Monitor

The Application Health Monitor is a separate service that monitors the IWSVA application and operating system health. It also communicates all necessary information with the HA Agent to allow rapid failover between the active and passive members.

## Link Loss Detection

The parent node monitors the Layer 2 switch connection for failures. If network connectivity is lost on the data port, a switchover is automatically generated to allow a rapid failover to the passive standby member.

The `linkloss_timeout` parameter controls the amount of downtime for the link loss detection. When the timer value set in the `linkloss_timeout` parameter is reached, the failover process is initiated.

The Health Monitor configuration file allows you to configure the `linkloss_timeout` value. The default is 10 seconds. It is located at in the Health Monitor configuration file at: `/etc/iscan/intscan.ini`.

```
[monitor]
linkloss_timeout=10
```

## About Central Management

Central Management is the feature used to manage two HA nodes as a single device. This allows configuration changes to take place on the parent unit and be automatically synchronized with the child unit.

---

**Note:** Central Management only applies to the active/passive pair scenario. It cannot be used for single devices.

---

Central Management automatically synchronizes configuration information between the parent and child members every five minutes. Administrators can also manually trigger synchronization by clicking the “Synchronize Now” button on the title bar of the IWSVA Web console Summary page accessed through the parent node.

IWSVA supports two synchronization mechanisms:

- **Automatic synchronization**—The parent node runs a scheduled task every five minutes to synchronize policies and configurations to the child node.
- **Manual synchronization**—Users can force a synchronization by clicking **Synchronize Now** on the **Administration > IWSVA Configuration > Summary** page of the Web console of the parent node.



Users cannot perform a manual switchover if the configurations on the two nodes are not synchronized. If the configurations are not synchronized during a switchover attempt, IWSVA displays a warning message instructing you to manually synchronize the two members first.

For automatic failovers, the switchover happens immediately without a forced synchronization, and any configuration changes made since the last completed synchronization are lost.

### Synchronizing Nodes Manually

Synchronization from the parent member to the child member occurs every five minutes. Administrators can manually trigger an immediate synchronization between the cluster members from the Cluster Management page.

#### To manually synchronize two nodes:

1. Go to the **System Status** page in the parent member Web console.
2. Click **Synchronize Now** at the top of the System Status page.
3. Click **OK** in the confirmation to immediately synchronize your policies and deployment settings from the parent member to the child member.

## Centrally Managed and Non-centrally Managed Features

Some features may be managed centrally, while others require administrators to log into the Web console of the parent or child node. See [Table 3-1](#) for details.

**TABLE 3-1. Centrally Managed vs. Non-centrally Managed Features**

| CLUSTER-LEVEL SETTINGS AVAILABLE THROUGH THE PARENT NODE | INSTANCE-LEVEL SETTINGS AVAILABLE THROUGH THE PARENT OR CHILD NODE                                             |
|----------------------------------------------------------|----------------------------------------------------------------------------------------------------------------|
| Enable/disable HTTP/HTTPS/FTP traffic                    | <ul style="list-style-type: none"> <li>• Dashboard /Virus/Malware/URL/Spyware/ Security Risk Report</li> </ul> |

**TABLE 3-1. Centrally Managed vs. Non-centrally Managed Features (Continued)**

| <b>CLUSTER-LEVEL SETTINGS AVAILABLE THROUGH THE PARENT NODE</b>                                                                                                                                                                                                      | <b>INSTANCE-LEVEL SETTINGS AVAILABLE THROUGH THE PARENT OR CHILD NODE</b>                                                                                                                                            |
|----------------------------------------------------------------------------------------------------------------------------------------------------------------------------------------------------------------------------------------------------------------------|----------------------------------------------------------------------------------------------------------------------------------------------------------------------------------------------------------------------|
| All HTTP/HTTPS policies and settings (under HTTP/HTTPS section) <ul style="list-style-type: none"> <li>• Includes HTTPS certifications</li> </ul>                                                                                                                    | Reports (features and data) <ul style="list-style-type: none"> <li>• Report Template</li> <li>• Manual Reports data</li> <li>• Scheduled Reports data</li> </ul>                                                     |
| All FTP policies and settings (under FTP section)                                                                                                                                                                                                                    | Logs (features and data) <ul style="list-style-type: none"> <li>• Log Analysis</li> </ul>                                                                                                                            |
| Report Settings <ul style="list-style-type: none"> <li>• Report Templates</li> </ul>                                                                                                                                                                                 | Updates (manual update)                                                                                                                                                                                              |
| Log Settings <ul style="list-style-type: none"> <li>• Syslog Configuration</li> <li>• Log Settings</li> </ul>                                                                                                                                                        | Test database connection feature (under Administration > IWSVA Configuration > Database Connection)                                                                                                                  |
| Update Settings <ul style="list-style-type: none"> <li>• Scheduled Update Settings</li> <li>• Connection Settings</li> </ul>                                                                                                                                         | Interface Configuration for data port and management port <ul style="list-style-type: none"> <li>• Hostname</li> <li>• IP address and net mask</li> <li>• Port for data interface or management interface</li> </ul> |
| Notification settings <ul style="list-style-type: none"> <li>• Notification page</li> <li>• Threshold Alert Settings on Summary page</li> <li>• SMTP settings</li> <li>• SNMP settings under Administration &gt; Network Configuration &gt; SNMP Settings</li> </ul> | TCMC Registration                                                                                                                                                                                                    |

**TABLE 3-1. Centrally Managed vs. Non-centrally Managed Features (Continued)**

| <b>CLUSTER-LEVEL SETTINGS AVAILABLE THROUGH THE PARENT NODE</b>                                                                                                                                                  | <b>INSTANCE-LEVEL SETTINGS AVAILABLE THROUGH THE PARENT OR CHILD NODE</b> |
|------------------------------------------------------------------------------------------------------------------------------------------------------------------------------------------------------------------|---------------------------------------------------------------------------|
| Quarantine Management (under Administration > Quarantine Management)                                                                                                                                             | System patch                                                              |
| System Time                                                                                                                                                                                                      | Update OS                                                                 |
| Network Settings (Except Hostname, IP, net mask, and port) <ul style="list-style-type: none"> <li>• Enable Ping for each interface</li> <li>• DNS</li> <li>• Default Gateway</li> <li>• Static Routes</li> </ul> | Support                                                                   |
| <b>Note:</b> DHCP is removed in HA                                                                                                                                                                               |                                                                           |
| Web Console settings (under Administration > Network Configuration > Web Console)                                                                                                                                |                                                                           |
| Remote CLI settings (under Administration > Network Configuration > Remote CLI)                                                                                                                                  |                                                                           |
| User accounts (under Administration)                                                                                                                                                                             |                                                                           |
| Configuration backup/restore                                                                                                                                                                                     |                                                                           |
| Product License                                                                                                                                                                                                  |                                                                           |

**TABLE 3-1. Centrally Managed vs. Non-centrally Managed Features (Continued)**

| CLUSTER-LEVEL SETTINGS AVAILABLE THROUGH THE PARENT NODE                                                                                                                                                                    | INSTANCE-LEVEL SETTINGS AVAILABLE THROUGH THE PARENT OR CHILD NODE                                                                                             |
|-----------------------------------------------------------------------------------------------------------------------------------------------------------------------------------------------------------------------------|----------------------------------------------------------------------------------------------------------------------------------------------------------------|
| <b>DEPLOYMENT WIZARD CONFIGURATIONS</b>                                                                                                                                                                                     |                                                                                                                                                                |
| System time<br>Deployment Mode<br>Static Routes<br>Data Interface & Management Interface <ul style="list-style-type: none"> <li>• DNS</li> <li>• Default gateway</li> <li>• Static Router</li> <li>• Enable PING</li> </ul> | Data Interface and Management Interface <ul style="list-style-type: none"> <li>• Hostname</li> <li>• IP address and net mask</li> <li>• Port number</li> </ul> |

## About Cluster Management

The Cluster Management screen is located at **Administration > IWSVA Configuration > Cluster Management** and is used to configure the HA cluster. The cluster settings are saved in the cluster configuration file and used by the Central Management feature and the HA Agent to create the HA policies and failover priorities. Changing the weight values of the cluster members allow manual parent/active member selection, but may also cause a switchover to occur. See [About Weighted Priority Election on page 2-6](#) for details.

## Cluster Configuration

Cluster configurations are settings that are replicated cluster-wide and every HA member is configured with the same cluster configuration information. The Central Management and Cluster Management components use cluster information to provide rapid failover without loss to critical policy and configuration information.

The cluster configuration file, `cluster.ini`, is stored in the `/etc/iscan` folder and is used to store the HA cluster settings. You can configure the following elements of a cluster through the Web console Cluster Management page:

- **Cluster Name**—The name of the cluster
- **Cluster Description**—The description of the cluster
- **Cluster IP Address**—The floating management IP address of the cluster is always associated with the active node. IWSVA can show both IPv4 and IPv6 addresses if configured for cluster, parent, and child, for example, as 172.16.2.200/2001:10::101.
- **Weighted Priority Election**—Enable or disable (default)
- **Cluster Members**—The list of the nodes (IPv4 or IPv6) belonging to the HA cluster with login access provided to the child nodes.

---

**Note:** For this version of IWSVA, the following items are not configurable:

- Cluster Deployment Mode—Always Transparent Bridge mode.
- HA Mode—Always active/passive.
- HA Cluster IP's do not support IPv6 addresses.

---

## Node Configuration

Node configuration settings are applied to a specific HA member and are not cluster-wide settings. These node-specific settings are never synchronized between the HA members. Node specific settings include the following:

- **Hostname**—The name of the node
- **Role**—Either parent or child
- **IP Address**—The IP address used on the heartbeat port. If this is empty, a new IP will be negotiated between the cluster members and written to the IP address parameter.
- **Weight**—The weight of the node. Valid values are 1-255. The higher the weight, the greater the chance the node will be selected to act as the parent node.
- **Status**—Status of the node. Green is up, red is down.
- **Last Synchronization**—Gives the date and time of the last successful synchronization
- **Synchronization Status**—Green is successful, red is failed. If failed, a reason displays in the tooltip.

## Cluster Logs and Notifications

The HA cluster logs and records the following events:

- Creating a cluster
- Dissolving or breaking apart an existing cluster
- Adding a member to a cluster
- Changing the configuration of a cluster
- Removing a member from a cluster
- Changing the role of a cluster member
- Performing manual synchronization
- Failing over
- Detecting an abnormality

Cluster notifications are issued when:

- Abnormalities are detected
- A failover occurs
- A member is restored
- A failover or switchover cannot be performed

## Accessing the Cluster

### To access the parent node:

Administrators can access the parent member's Web management interface through one of two IP addresses:

- Parent member's management IP address and port number
- Cluster IP address and port number

Example:

```
http://<parent management IP address>:<portnumber>
```

```
http://<cluster IP address>:<portnumber>
```

**To access the child node:**

Administrators can log into the Web management console of the child node two ways:

- Through the link on the Cluster Management page (**Administration > IWSVA Configuration > Cluster Management > Login** button for child node)
- Through the management port IP address of the child node

Example:

`http://<child node IP address>:<portnumber>`

To protect against accidental configuration, all cluster-level features are hidden or blocked in the child member's Web management interface. (Compare the parent node left menu in [Figure 3-1](#) with the child node left menu in [Figure 3-2](#).) Only the child member applicable configuration parameters that apply specifically to the child member are exposed and configurable through the child member's Web management interface. [Table 3-1](#) gives a detailed list of child-level settings and features.

Current Server: iwsva60-40 (parent) Synchronize Now

Cluster Management

**Cluster Settings** Modify

Cluster Name : iwsesi  
 HA Mode : Active/Passive  
 Cluster IP Address : 10.204.151.179  
 Deployment Mode : Bridge  
 Weighted Priority Election : Disabled  
 Description : HANAHAN

**Cluster Member** Refresh

Switch Roles

| Hostname   | Role   | IP address     | Weight | Status                              | Last synchronized   | Synchronized status                 |
|------------|--------|----------------|--------|-------------------------------------|---------------------|-------------------------------------|
| iwsva60-40 | parent | 10.204.151.178 | 128    | <input checked="" type="checkbox"/> | N/A                 | N/A                                 |
| iwsva60-43 | child  | 10.204.151.177 | 64     | <input checked="" type="checkbox"/> | 2013-04-08 20:02:16 | <input checked="" type="checkbox"/> |

Cluster Management Page has Child Node Login Access

**FIGURE 3-1.** Parent Node Cluster Management Page has Child Node Login Access

If administrators need to change cluster-level settings while logged into the child member, they can simply login to the parent member through the **Login** button posted beside the parent member on the Cluster Management screen.

IWSVA HA uses single sign-on technology to pass authentication credentials between cluster members so typing a password to access other members are not necessary.



**FIGURE 3-2.** Child node Cluster Management page with access to the parent node.

**Note:** CLI commands for centrally managed features are not available on the child node.



## Cluster Management Web Console Page

From the Cluster Management page at **Administration > IWSVA Configuration > Cluster Management**, administrators can configure the following:

- [Deleting a Child Member from a Cluster on page 3-15](#)
- [Dissolving a Cluster on page 3-15](#)
- [Performing a Manual Switchover on page 3-16](#)
- [Synchronizing Nodes Manually on page 3-7](#)
- [Modifying a Cluster on page 3-17](#)

### Deleting a Child Member from a Cluster

If you delete a child node from a cluster, the cluster still exists with the parent node as the only member. Another node can be added later as a child node.

#### To delete a child node:

1. Go to **Administration > IWSVA Configuration > Cluster Management** in the parent member Web console.
2. Go the **Cluster Member** section of the page.
3. Click the delete icon (  ) in the child row to delete the child member.
4. Click **OK** to confirm the deletion. A progress bar displays.
5. If, after a few second, if the deletion has not completed, click your browser's **Refresh** button.

The child member no longer displays in the Cluster Member list and the former child node will return to Forward Proxy mode.

### Dissolving a Cluster

Dissolving an HA cluster breaks apart the HA cluster and occurs after the child member and parent member have been deleted. Dissolving an HA cluster returns the active HA member to a standalone IWSVA device operating in Transparent Bridge mode.

**To dissolve a cluster:**

1. Go to **Administration > IWSVA Configuration > Cluster Management** in the parent member Web console.
2. Delete the child member of the cluster as shown in [Deleting a Child Member from a Cluster on page 3-15](#).
3. In the **Cluster Member** section of the page, click the delete icon (  ) to delete the parent member.
4. Click **OK** to confirm the dissolution. A progress bar displays.
  - a. If, after five minutes, if the dissolution has not completed, click your browser's **Refresh** button.

The parent member become a standalone IWSVA unit in Transparent Bridge mode and the Cluster Management page no longer displays.

### Performing a Manual Switchover

Administrators can manually switch the parent/child roles of the two members in an HA cluster. After a successful switchover, the original parent member becomes the child member and goes into passive mode. The original child member becomes the parent member and goes into active mode.

---

**Note:** Administrators can only perform a manual switchover if the Weighted Priority Election process is disabled. To perform a switchover with Weighted Priority Election mode enabled, administrators must modify the weight of each member to trigger an HA switchover. See [Modifying a Cluster on page 3-17](#) for details on changing the weight value for a cluster member.

---

**To perform a manual switchover with Weighted Priority Election mode disabled:**

**Note:** If IWSVA is performing a synchronization, either a manually or a scheduled synchronization, the Synchronized Status shows “Syncing ...”, and manual switchovers are prevented. This applies to switchovers when the Weight Priority Election mode is disabled (by switching roles) or if attempting to change the weight value of a node with the Weighted Priority Election mode enabled. Automatic failovers still occur even if synchronization is in progress, reverting to the policies and deployment settings that existed after the most recent successful synchronization.

1. Go to **Administration > IWSVA Configuration > Cluster Management** in the parent node Web console.
2. In the Cluster member section, click **Switch Roles**.
3. Click **OK** in the confirmation to switch roles and be re-logged into the new parent node.

**Modifying a Cluster**

The Cluster Management page allows administrators to view cluster settings, modify cluster settings, and to switch roles between parent and child servers.

*Table 3-2* shows the Cluster Settings displayed on the Cluster Management page.

**TABLE 3-2. Cluster Settings**

| VALUE              | DESCRIPTION                                                                                                                                                      |
|--------------------|------------------------------------------------------------------------------------------------------------------------------------------------------------------|
| Cluster Name       | This is the name assigned to the cluster when it was first created in the Deployment Wizard. (Modifiable)                                                        |
| HA Mode            | Active/Passive (Not modifiable)                                                                                                                                  |
| Cluster IP Address | The floating IP address used to log into the cluster from the Web console or CLI. This IP address remains the same, even after a switchover occurs. (Modifiable) |
| Description        | Displays the (optional) description entered when the cluster was added through the Deployment Wizard. (Modifiable)                                               |



**TABLE 3-2. Cluster Settings (Continued)**

| VALUE                      | DESCRIPTION                                                                                                                                  |
|----------------------------|----------------------------------------------------------------------------------------------------------------------------------------------|
| Deployment Mode            | Currently, this parameter always displays “Bridge” because IWSVA HA clusters are only supported in Transparent Bridge mode. (Not modifiable) |
| Weighted Priority Election | Displays either Enabled or Disabled. (Modifiable)                                                                                            |
| Switch Roles               | Allows administrators to switch roles between parent and child members.                                                                      |
| Refresh                    | Updates the status of cluster members                                                                                                        |



This Cluster Members section of the Cluster Management page displays the cluster members (parent and child members), gives status details, and allows login access to the child node.

*Table 3-3* shows the parameters displayed for both parent and child nodes.

**TABLE 3-3. Cluster Member Settings**

| PARAMETER  | DESCRIPTION                                                                                                                                                                                                                       |
|------------|-----------------------------------------------------------------------------------------------------------------------------------------------------------------------------------------------------------------------------------|
| Hostname   | Displays the server name                                                                                                                                                                                                          |
| Role       | Displays either Parent or Child                                                                                                                                                                                                   |
| IP Address | Displays the IP address of the device.                                                                                                                                                                                            |
| Weight     | Displays the weight entered when the cluster was configured.<br>(Default: parent 128/child 64- Modifiable)                                                                                                                        |
| Status     | Displays the following icons:<br> Up status<br> Down status |

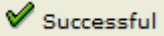
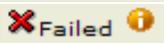
**TABLE 3-3. Cluster Member Settings (Continued)**

| PARAMETER              | DESCRIPTION                                                                                                                                                                                                                                                                                                                                                                                                                                                                                                                                                                                                                                                                                                                                                                                               |
|------------------------|-----------------------------------------------------------------------------------------------------------------------------------------------------------------------------------------------------------------------------------------------------------------------------------------------------------------------------------------------------------------------------------------------------------------------------------------------------------------------------------------------------------------------------------------------------------------------------------------------------------------------------------------------------------------------------------------------------------------------------------------------------------------------------------------------------------|
| Last Synchronized      | Displays the date and time (hours: minutes: seconds) when the child server was last synchronized with the parent.                                                                                                                                                                                                                                                                                                                                                                                                                                                                                                                                                                                                                                                                                         |
| Synchronization Status | Displays the following:<br><div style="display: flex; justify-content: space-around; align-items: flex-start;"> <div style="text-align: center;"> <br/>N/A </div> <div style="text-align: center;"> <br/>Successful </div> <div style="text-align: center;"> <br/>Failed </div> <div style="text-align: center;"> <br/>           Success<br/>           Failed. If failed, an information tool tip displays the reason why the synchronization failed. </div> </div> |
| Dissolve               | Displays an icon (  ) to delete the child member. The icon only displays for the parent member if the child member has been deleted. Deleting the parent member dissolves the whole cluster.                                                                                                                                                                                                                                                                                                                                                                                                                                                                                                                             |

**To modify cluster settings:**

1. Go to **Administration > IWSVA Configuration > Cluster Management**.
2. Click the **Modify** link by the Cluster Settings heading.
3. In the Cluster Settings page, modify the following parameters as needed:
  - **Cluster Name**—Displays the name assigned to the cluster when it was first created in the Deployment Wizard. (Modifiable)
  - **Description**—Displays the (optional) description, if any, entered when the cluster was added through the Deployment Wizard. (Modifiable)
  - **Floating IP Address**—Displays the floating management (or cluster) IP address used to log into the cluster from the Web console or CLI. The floating IP address is always associated with the active node in the cluster. (Modifiable)
  - **Weighted Priority Election**—Displays either Enabled or Disabled. If the Weighted Priority Election value is set to enable, the HA pair launches an election to choose the maximum weighted machine. If the Weighted Priority Election value is set to disable, the HA pair only launches an election when the current active (or primary) machine is not available. (Modifiable)

- **HA Mode**—Active/Passive (Display only)
  - **Deployment Mode**—Currently, this parameter always displays “Bridge” because IWSVA HA clusters are only supported in Transparent Bridge mode. (Display only)
4. Click **Save**.

**To change the weight value of a node:**

---

**Note:** The Weighted Priority Election mode must be set to Enable to perform the following procedure. (To enable the Weight Priority Election mode, see [To modify cluster settings: on page 3-19](#), Step 3.) Roles can be switched manually if the Weighted Priority Election is disabled. See [Performing a Manual Switchover on page 3-16](#) for details.

---

1. Go to **Administration > IWSVA Configuration > Cluster Management**.
2. In the “Cluster Members” section, click the **weight value** to be changed.
3. In the Weight screen, change the weight value to reflect the appropriate value. (1-255, higher value = higher priority.)
4. Click **Save**.

If you change a child member’s weight value to be greater than the parent member’s weight value, and the Weighted Priority Election has been enabled, roles for the two members will be switched.

# Chapter 4

## Updates

Because new malicious programs and offensive Web sites are developed and launched daily, it is imperative to keep your software updated with the latest pattern files and engines, as listed on the Updates Schedule page on the InterScan™ Web Security Virtual Appliance (IWSVA) Web console.

Topics in this chapter include the following:

- [Product Maintenance on page 4-2](#)
- [About ActiveUpdate on page 4-3](#)
- [Proxy Settings for Updates on page 4-4](#)
- [Updatable Program Components on page 4-5](#)
- [Manual Updates on page 4-10](#)
- [Scheduled Updates on page 4-12](#)
- [Maintaining Updates on page 4-13](#)
- [Controlled Virus Pattern Releases on page 4-14](#)

## Product Maintenance

From time to time, Trend Micro might release a patch for a reported known issue or an upgrade that applies to your product. To find out whether there are any patches available, visit the following URL:

<http://downloadcenter.trendmicro.com>

Clicking the link for IWSVA takes you to the Update Center page for IWSVA.

Enter the following search criteria:

- **Category:** Internet Gateway
- **Product:** InterScan Web Security Virtual Appliance
- **Version:** Current product version

Patches are dated. If you find a patch that you have not applied, open the readme document to determine whether the patch applies to you. If so, follow the upgrade instructions in the readme.

## Renewing Your Maintenance Agreement

Trend Micro or an authorized reseller provides technical support, virus pattern downloads, and program updates for one (1) year to all registered users, after which you must purchase renewal maintenance.

If your Maintenance Agreement expires, scanning is still possible, but virus pattern and program updates stop. To prevent this, renew the Maintenance Agreement as soon as possible.

To purchase renewal maintenance, contact the same vendor from whom you purchased the product. A Maintenance Agreement, extending your protection for a year, is sent by post to the primary company contact listed in your company's Registration Profile.

To view or modify your company's Registration Profile, log into the account at the Trend Micro online registration Web site:

<https://olr.trendmicro.com/registration>

To view your Registration Profile, type the Logon ID and Password created when you first registered your product with Trend Micro (as a new customer), and click **Login**.



## About ActiveUpdate

ActiveUpdate is a service common to many Trend Micro products. ActiveUpdate connects to the Trend Micro Internet update server to enable downloads of the latest pattern files and engines.

ActiveUpdate does not interrupt network services, or require you to reboot your computers. Updates are available on a regularly scheduled interval that you configure, or on demand.

## Updating From the IWSVA Web Console

If you are not using Trend Micro Control Manager for centralized administration of your Trend Micro products, IWSVA polls the ActiveUpdate server directly. Updated components are deployed to IWSVA on a schedule you define, such as the following:

- Minutes (15, 30, 45, 60)  
These 15-minute interval updates only apply to virus, spyware, phishing, URL Filtering page analysis, and IntelliTrap patterns.
- Hourly
- Daily
- Weekly
- On demand (manually)

---

**Note:** Trend Micro recommends hourly updates of the pattern files and daily and weekly updates of engines. All updates include the following patterns: virus, spyware, phishing, URL Filtering page analysis, and IntelliTrap patterns.

---

## Proxy Settings for Updates

If you use a proxy server to access the Internet, you must enter the proxy server information into the IWSVA Web console before attempting to update components. Any proxy information that you enter is used for the following:

- Updating components from Trend Micro's update servers
- Product registration and licensing
- Web reputation queries

### To configure a proxy server for component and license updates:

1. Open the IWSVA Web console and click **Updates > Connection Settings**.
2. Select **"Use a proxy server for pattern, engine, license updates and Web Reputation queries"** to specify a proxy server or port. IWSVA supports both the IPv4 and IPv6 AU servers. The Update Proxy also supports the IPv6 proxy, or the IPv4 proxy by hostname or IPv4/IPv6 address.

3. If your proxy server requires authentication, type a user ID and password in the fields provided.

Leave these fields blank if your proxy server does not require you to authenticate.

4. In the **Pattern File Setting** section, type the number of pattern files to keep on the IWSVA device after updating to a new pattern (default and recommended setting is three pattern files).

Keeping old pattern files on your server allows you to roll back to a previous pattern file in the event of an incompatibility with your environment; such as excessive false positives. When the number of pattern files on the server exceeds your configuration, the oldest pattern file is automatically deleted.

5. Click **Save**.

---

**Note:** In transparent bridge mode, the IWSVA has an internal interface and an external interface. To ensure updates function properly, the configuration of the ActiveUpdate proxy and server settings must be done on the same side. If IWSVA is deployed with other proxy servers, the next hop proxy settings for the ActiveUpdate proxy and server should be the same server on the same side of the interface.

---

## Updatable Program Components

To ensure up-to-date protection against the latest risks, there are several components you can update:

- **Pattern files**—These files are: Virus, phish spyware/grayware, URL filtering page analysis, IntelliTrap, and IntelliTrap Exceptions. These files contain the binary “signatures” or patterns of known security risks. When used in conjunction with the scan engine, IWSVA is able to detect known risks as they pass through the Internet gateway. New virus pattern files are typically released at the rate of several per week, while the Phish and grayware/spyware pattern files are updated less frequently.
- **Virus scan engine**—This module analyzes each file’s binary patterns and compares them against the binary information in the pattern files. If there is a match, the file is determined to be malicious.
- **URL Filtering Engine**—IWSVA utilizes the Trend Micro URL Filtering Engine to perform URL categorization and reputation rating based on the URL data supplied from the cloud-based Smart Protection Network. Trend Micro recommends using the default setting of a weekly update check to ensure that your installation has the most current URL Filtering Engine.

### Virus Pattern File

The Trend Micro scan engine uses an external data file, called the virus pattern file, to keep current with the latest viruses and other Internet risks such as Trojans, mass mailers, worms, and mixed attacks. New virus pattern files are created and released several times a week, and any time a particularly pernicious risk is discovered.

All Trend Micro antivirus programs using the ActiveUpdate feature (see [About ActiveUpdate starting on page 4-3](#) for details) can detect whenever a new virus pattern is available at the server, and can be scheduled to automatically poll the server every hour, day, week, and so on, to get the latest file. Virus pattern files can also be manually downloaded from the following Web site:

<http://www.trendmicro.com/download/pattern.asp>

There, you can find the current version, release date, and a list of the new virus definitions included in the file.

## How it Works

The scan engine works together with the virus pattern file to perform the first level of detection, using a process called pattern matching. Because each virus contains a unique binary “signature” or string of tell-tale characters that distinguishes it from any other code, the virus experts at TrendLabs capture inert snippets of this code to include in the pattern file. The engine then compares certain parts of each scanned file to the data in the virus pattern file looking for a match.

Pattern files use the following naming format:

```
lpt$vpn.###
```

where `###` represents the pattern version (for example, 400). To distinguish a given pattern file with the same pattern version and a different build number, and to accommodate pattern versions greater than 999, the IWSVA Web console displays the following format:

```
roll number.pattern version.build number (format: xxxxx.###.xx)
```

- `roll number`—This represents the number of rounds when the pattern version exceeds 999 and could be up to five digits.
- `pattern version`—This is the same as the pattern extension of `lpt$vpn.###` and contains three digits.
- `build number`—This represents the patch or special release number and contains two digits.

If multiple pattern files exist in the same directory, only the one with the highest number is used. Trend Micro publishes new virus pattern files on a regular basis (typically several times per week), and recommends configuring a hourly automatic update on the **Updates > Schedule** screen. Updates are available to all Trend Micro customers with valid maintenance contracts.

---

**Note:** There is no need to delete the old pattern file or take any special steps to “install” the new one.

---

## Page Analysis Pattern

URL filtering page analysis pattern is used by the URL filtering engine to perform local page analysis and adjust the final reputation score of a visited Web page. If the result of the analysis indicates that the Web page contains malicious content, IWSVA automatically decreases its reputation score and returns the revised score to the reputation server.

The URL filtering page analysis pattern file is stored in the following directory:

```
/etc/iscan/Ctx#####.###
```

## Spyware/Grayware Pattern File

As new hidden programs (grayware) that secretly collect confidential information are written, released into the public, and discovered, Trend Micro collects their tell-tale signatures and incorporates the information into the spyware/grayware pattern file. The spyware/grayware pattern file is stored in the following directory:

```
/etc/iscan/ssaptn.###
```

where ### represents the pattern version. This format distinguishes a given pattern file with the same pattern version and a different build number. It also accommodates pattern versions greater than 999. The IWSVA Web console displays the following format:

```
roll number.pattern version.build number (format: xxxxx.###.xx)
```

- `roll number`—This represents the number of rounds when the pattern version exceeded 999 and could be up to five digits.
- `pattern version`—This is the same as the pattern extension of `ssaptn.###` and contains three digits.
- `build number`—This represents the patch or special release number and contains two digits.

## IntelliTrap Pattern and IntelliTrap Exception Pattern Files

IntelliTrap detection uses a scan option in the Trend Micro's virus scanning engine with IntelliTrap pattern (for potentially malicious files) and IntelliTrap Exception pattern (as an allowed list). IWSVA uses the IntelliTrap option and patterns available for detecting malicious compressed files, such as bots in compressed files. Virus writers often attempt

to circumvent virus filtering by using different file compression schemes. IntelliTrap provides a heuristic evaluation of compressed files to help reduce the risk that a bot or any other malicious compressed file might cause to a network.

IntelliTrap pattern `tblack.###` and IntelliTrap exception pattern `tmwhite.###` are saved in the `/etc/iscan/` directory.

## Scan Engine

At the heart of all Trend Micro antivirus products lies a proprietary scan engine. Originally developed in response to the first computer viruses the world had seen, the scan engine today is exceptionally sophisticated. It is capable of detecting Internet worms, mass-mailers, Trojan horse risks, network exploits and other risks, as well as viruses. The scan engine detects the following types of risks:

- “in the wild,” or actively circulating
- “in the zoo,” or controlled viruses that are not in circulation, but are developed and used for research and “proof of concept”

In addition to having perhaps the longest history in the industry, the Trend Micro scan engine has also proven in tests to be one of the fastest—whether checking a single file, scanning 100,000 files on a desktop machine, or scanning email traffic at the Internet gateway. Rather than scan every byte of every file, the engine and pattern files work together to identify not only tell-tale characteristics of the virus code, but the precise location within a file where the virus would hide. If a virus is detected, it can be removed and the integrity of the file restored.

To help manage disk space, the scan engine includes an automatic clean-up routine for old viruses, spyware, and IntelliTrap pattern files as well as incremental pattern file updates to help minimize bandwidth usage.

In addition, the scan engine is able to decode all major internet encoding formats (including MIME and BinHex). It also recognizes and scans common compression formats, including Zip, Arj, and Cab. Most Trend Micro products also allow administrators to determine how many layers of compression to scan (up to a maximum of 20), for compressed files contained within a compressed file.

It is important that the scan engine remains current with the latest risks. Trend Micro ensures this in two ways:

- Frequent updates to the scan engine's data file, called the virus pattern file, which can be downloaded and read by the engine without the need for any changes to the engine code itself.
- Technological upgrades in the engine software prompted by a change in the nature of virus risks, such as the rise in mixed risks like Italian Job.

In both cases, updates can be automatically scheduled, or an update can be initiated on demand.

The Trend Micro scan engine is certified annually by international computer security organizations, including the International Computer Security Association (ICSA).

## About Scan Engine Updates

By storing the most time-sensitive virus information in the virus pattern file, Trend Micro is able to minimize the number of scan engine updates, while at the same time keeping protection up-to-date. Nevertheless, Trend Micro periodically makes new scan engine versions available. New engines are released, for example, when:

- New scanning and detection technologies have been incorporated into the software
- A new, potentially harmful virus is discovered that cannot be handled by the current engine
- Scanning performance is enhanced
- Support is added for additional file formats, scripting languages, encoding, and/or compression formats

To view the version number for the most current version of the scan engine, visit:

<http://downloadcenter.trendmicro.com/engine.asp>

## Web Reputation Database

The Web Reputation database resides in the cloud with rest of the Trend Smart Protection Network servers. When a user attempts to access a URL, IWSVA retrieves information about this URL from the Web Reputation database and stores it in the local cache. Having the Web Reputation database in the cloud and building the local cache with this database information reduces the overhead on IWSVA and improves performance.

The following are the information types the Web Reputation database can retrieve for a requested URL:

- Web category
- Pharming and phishing flags used by anti-pharming and anti-phishing detection
- Web Reputation scores used to block URL access, based on a specified sensitivity level (see [Specifying Web Reputation Rules on page 8-42](#))

The Web Reputation database is updated with the latest categorization of Web pages.

If you believe the reputation of a URL is misclassified or you want to know the reputation of a URL, please use the link below to notify Trend Micro:

<http://global.sitesafety.trendmicro.com/>

## Incremental Updates of the Pattern Files and Engines

ActiveUpdate supports incremental updates of the latest pattern and engine files. Rather than downloading the entire file each time, ActiveUpdate can download only the portion of the file that is new and append it to the existing file. This efficient update method can substantially reduce the bandwidth needed to update your antivirus software, deploy pattern, and engine files throughout your environment.

## Component Version Information

To know which pattern file, scan engine, or application build you are running, click **Updates > Manual** on the main menu and select an item in the *Patterns and Signatures* list. The version in use is displayed in the Current Version column on the **System Dashboard** tab.

## Manual Updates

The effectiveness of IWSVA depends upon using the latest pattern and engine files. Signature-based virus and spyware/grayware scanning works by comparing the binary patterns of scanned files against binary patterns of known risks in the pattern files. Trend Micro frequently releases new versions of the virus pattern and spyware pattern in response to newly identified risks. Similarly, new versions of the Phish pattern are released as new phishing URLs are identified.



New versions of the Trend Micro scan engine are updated as performance is improved and features added to address new risks.

---

**Note:** If Internet connections on your network pass through a proxy server, you need to configure your proxy information. Click **Updates > Connection Settings** from the main menu and enter your proxy server information.

---

**To update the engines and pattern files:**

1. Click **Updates > Manual**.
2. For all of the components listed on the Manual Update screen, click one of the following:
  - **Update All**—Updates all components
  - **Update**—Updates only the selected component

If IWSVA is already using the latest version of the component and no update is available, no component is updated. Forcing an update (by clicking **Update**) is not necessary unless the components on the IWSVA device are corrupt or unusable.

## Forced Manual Updates

IWSVA provides an option to force an update to the pattern file and the scan engine when the version on IWSVA is greater than or equal to its counterpart on the remote download server (normally IWSVA would report that no updates are available). This feature is useful when a pattern file or scan engine is corrupt and you need to download the component again from the update server.

**To force an update of a pattern file or scan engine:**

1. Click **Updates > Manual** on the main menu to display the Manual Update screen.
2. For all of the components listed, click **Update** to update only the selected component(s)

A message box appears if the version of the pattern file or scan engine on IWSVA is greater than or equal to the counterpart on the remote download server. If the pattern file on IWSVA is older than the one on the remote download server, the newer pattern file is downloaded.

3. Click **OK** in the message box to start the forced update.

## Scheduled Updates

IWSVA can perform scheduled updates for the following pattern files:

- Virus (includes Trojan and worm signatures)
- Spyware
- Bot pattern
- URL page analysis
- IntelliTrap

Likewise, IWSVA can perform scheduled updates for the Scan and URL Filtering engines.

### To schedule automatic pattern file and engine updates:

1. Click **Updates > Schedule** on the main menu.
2. For each type of updatable component, select the update interval.

The following are your options:

- Every  $x$  minutes (pattern files only; select the number of minutes between update interval)
- Hourly (pattern files only)
- Daily
- Weekly (select a day from the drop-down menu; this is the recommended setting for the latest engine updates)

---

**Note:** Scheduled updates for a given component can be disabled by selecting **Manual updates only** in each component section.

---

3. For each component, select a **Start time** for the update schedule to take effect.
4. Click **Save**.

---

**Note:** If your network configuration includes a cache server, Trend Micro recommends that you clear the cache and reboot the cache server after updating the pattern file. This forces all URL requests to be scanned, ensuring better network protection. Consult your cache server documentation for information on how to clear the cache and reboot the server.

---

## Maintaining Updates

### Update Notifications

IWSVA can issue notifications to proactively inform an administrator about the status of a pattern or engine update. For more information about configuring update-related notifications, see [Enabling Pattern File Updates Notifications starting on page 13-33](#) and [Enabling Notifications for URL Filtering Engine and Scan Engine Updates starting on page 13-39](#).

### Rolling Back an Update

IWSVA checks the program directory and uses the latest pattern file and engine library file to scan inbound/outbound traffic. It can distinguish the latest pattern file by its file extension; for example, `1pt$vpn.401` is newer than `1pt$vpn.400`.

Occasionally, a new pattern file might incorrectly detect a non-infected file as a virus infection (known as a “false positive”). You can revert to the previous pattern file or engine library file.

---

**Note:** IWSVA does not support rollback for the URL filtering engine.

---

#### To roll back to a previous pattern file or scan engine:

1. Click **Updates > Manual** on the main menu.
2. Select the component to roll back and click **Rollback**.

A progress bar indicates the rollback progress, and a message screen then displays the outcome of the rollback.

### Deleting Old Pattern Files

After updating the pattern file, IWSVA keeps old pattern files (Virus, Spyware, IntelliTrap, and IntelliTrap Exception pattern files) on the server so they are available to accommodate a roll back. The number of pattern files kept on the server is controlled by the “**Number of pattern files to keep**” setting on the **Updates > Connection Settings** page.

If you need to manually delete pattern files, they can be found in the `/etc/iscan/` directory of IWSVA.

## Controlled Virus Pattern Releases

There are two release versions of the Trend Micro virus pattern file:

- The Official Pattern Release (OPR) is Trend Micro's latest compilation of patterns for known viruses. It is guaranteed to have passed a series of critical tests to ensure that customers get optimum protection from the latest virus risks. Only OPRs are available when Trend Micro products poll the ActiveUpdate server.
- A Controlled Pattern Release (CPR) is a pre-release version of the Trend Micro virus pattern file. It is a fully tested, manually downloadable pattern file, designed to provide customers with advanced protection against the latest computer viruses and to serve as an emergency patch during a virus risk or outbreak.

---

**Note:** After you apply a CPR, incremental updates are not possible. This means that subsequent updates require downloading the entire pattern file rather than just the new patterns, resulting in a slightly longer pattern download time.

In order for IWSVA to access the new pattern file, ensure that it has the same permission and ownership as the previous pattern file.

---

### To apply the latest CPR to IWSVA:

1. Open <http://www.trendmicro.com/download/pattern-cpr-disclaimer.asp> and click **Agree** to signify your agreement with the terms and conditions of using a Trend Micro CPR.
2. Download the CPR to a temporary folder on the IWSVA device. The filename is in the form `lptXXX.zip`.
3. Stop all IWSVA services.
4. Extract the contents of the files that you downloaded to the `/etc/iscan/` directory of IWSVA.
5. Restart all IWSVA services.

# Chapter 5

## Application Control

InterScan Web Security Virtual Appliance (IWSVA) provides a way to control application usage by protocol and displays useful traffic statistics about inbound and outbound application traffic.

---

**Note:** To use the Application Control feature, IWSVA must be deployed in Transparent Bridge Mode, Transparent Bridge Mode-High Availability, or Forward Proxy Modes. For more information, see [Transparent Bridge Mode on page 2-3](#), [Transparent Bridge Mode - High Availability on page 2-4](#), or [Forward Proxy Mode on page 2-9](#).

---

Topics in this chapter include the following:

- [Application Control Overview on page 5-2](#)
- [Application Control Policy List on page 5-2](#)
- [Traffic Monitoring Overview on page 5-9](#)

## Application Control Overview

Internet-based applications have grown in popularity over the last few years beyond using the browser to surf websites. Even with corporate usage policies, many companies are unable to curb and regulate the use of those applications. Recent findings show that 75% to 80% of corporate users ignore their company's computer usage policies. To avoid significant risk, the Application Control feature provides a security technology that automates the discovery of popular Internet applications and allows administrators to control them by using policies.

IWSVA provides both visibility and control for over 800 application types running across any port, including applications using custom clients (for example, Skype, bitTorrent, P2P) or leveraging Web 2.0 technologies within the browser (for example, social networking, webmail, and streaming media sites).

---

**Note:** Application Control is available in Transparent Bridge Mode, Transparent Bridge Mode - High Availability, and Forward Proxy Mode.

---

Enabling or disabling of the Application Control will not affect policies already created. They will be synchronized between HA nodes and are included in migration packages.

Change actions in Application Control policies and settings are recorded in the Audit Log.

## Application Control Policy List

The Application Control feature allows more than a simple allow-or-block option for all examples of applications within a category. This flexibility is provided because many companies have found specific functions of these applications are effective for conducting business. Granular application control allows you to not only block and allow an application like Facebook, for example, but you could also allow the application, and still block newly posted messages.

Administrators may want to allow the two most popular IM applications, but block the rest. For P2P, administrators may want to allow the transfer of files between employees within the corporate network, but prohibit external use.

Creating Application Control policies allows granular control of the functionality within the supported Internet-based application categories.



The Application Control policy list shows all policies on the system (for IPv4 and IPv6 addresses)—enabled as well as disabled. Go to **Application Control > Policies**. Click **Add** to create a new policy, or click a policy name to edit an existing one.

- **Enable Application Control**—Globally controls the enabled status of all policies; overrides the status of an individual policy. Click **Save** after enabling or disabling Application Control. Enabling or disabling of the Application Control will not affect policies already created. They will be synchronized between HA nodes and are included in migration packages.
- **Add**—Opens the Add Policy wizard that will take you through the steps of defining a new policy.
- **Priority**—Sets the order of precedence—if two conflicting policies overlap in their scope, the policy with the higher priority (closer to 1) will be applied and the other ignored.

---

**Note:** The Application Control Global Policy is the default policy. It automatically applies to all users, but also always takes the lowest priority. Any policy above it in the list will take precedence.

---

- **Deploy Policies**—Click this button after creating or modifying an Application Control policy to have it immediately take effect. This avoids waiting for the policy deployment interval.
- **Schedule objects**—Click these objects and select from the drop-down box to sort by the blocked or allow option, so you can display your policies for each time by action.
- **Collapse and expand category**—The Expand icon () allows you to see the contents of all the application category. The Collapse icon () allows you to close all application categories.
- **Search**—When creating policies, you can use the search field to find the applications you want to add to your policy rules.

**To view Application Control policies:**

1. Go to **Application Control > Policies**.
2. Click the name of an existing policy to see the details about that policy.  
The Global Application Control policy is the default policy.
3. To add a policy, see [Adding an Application Control Policy on page 5-5](#).

## Add Policies: Select Accounts

IWSVA has default global and guest policies for the following activities: HTTPS decryption, Advanced Threat Protection, Applets and Active X, URL Filtering, and Application Control.

- **Global Policy**—For all clients who access through IWSVA.
- **Guest Policy**—For those clients, typically temporary workers, contractors, and technicians who proxy through IWSVA using a special guest account.

The Global Application Control policy is the default policy.

- **Enable policy**—Enables or disables the individual policy; the global Application Control setting overrides the specifications of an individual policy.
- **IP Range**—Use to specify the range of IP addresses (IPv4 and/or IPv6) that will be affected by the Application Control policy.
- **IP Address/(User or Group possible)**—Use to specify the single IP address (IPv4 or IPv6) that will be affected by the Application Control policy.

---

**Note:** The options on this page depend upon the user identification method that you are using—either IP address or User/group name authentication, if you enable LDAP authentication. For more information about configuring the user identification method and defining the scope of a policy, see [Configuring the User Identification Method on page 7-6](#) and [Configuring the Scope of a Policy on page 7-17](#).

---

- **Add**—Click to add a single or range of IP addresses to the list of addresses that will be affected by the Application Control policy.



## Adding an Application Control Policy

### To add an Application Control policy:

1. Go to **Application Control > Policies**.
2. Click the **Add** link at above the policy list.
3. Type a descriptive new policy name. This will help you remember the policy.
4. You can also create a new policy based on the settings of an existing policy by clicking the “Copy from existing policy” option and selecting a policy from the drop-down list.
5. Type a single IP address, a range of IP addresses, or a user/group name to signify the users affected. Alternatively, choose the user or group name if LDAP integration has been set up.
6. Click **Add** to move the newly entered IP address, range, or user/group name to the Type & Identification table.
7. Check the **Enable Policy** check box at the top of the screen to enable the policy after it is created.
8. Click **Next** to continue.
9. See [Specifying Application Control Policy Rules on page 5-6](#) to set up the rules of the policy which apply to specified accounts.

## Add or Edit Policies: Specify Rules for Application Control Policies

You add or edit policy rules in two locations:

- **Application Control > Policies | Add > Select Account > Specify Rules**
- **Application Control > Policies | Policy Name | Rule** (to edit an existing policy)

Adding an Application Control policy is a two-step procedure. First, create an account to specify the users to which the policy will apply, then assign Application Control rules to the policy.

---

**Note:** Use the search field to find a specific application on the Rules page. For more information about an application, click the name of the application to go to a separate page that contains information describing the supported applications, versions and other details.

---

## Specifying Application Control Policy Rules

Editing an Application Control policy requires clicking on the policy name, then clicking the Rule tab.

- **Enable policy**—Enables or disables the individual policy; the global Application Control policy settings override the specifications of an individual policy.
- **Application Category**—Choose an action for the protocols to which you want to restrict access. There are over 420 protocols segmented in 32 logical groups. Use the search field to find specific application names.
  - Click on the “+” sign to expand a category and select specific protocols.
  - Click the protocol name to access a page with descriptions of the protocols.

---

**Note:** When you create a policy, current connections will not be blocked by the new policy. For example: If a user is logged on to Skype while an admin creates a policy to block Skype, the user can continue to use Skype. However, once the user logs off, he cannot log back on to Skype again because the policy will be in effect.

---

Use the following available filtering actions:

- Deny Instant Messages
- Deny Upload File
- Deny Download File
- Deny Transfer File
- Deny Post Message
- Deny Update Status
- Deny Play Media

Selecting the “allow” or “block” action can be supported by all applications, and other actions can be supported by part of the applications. As a result, the policy setting process is:

- **Option 1:** Group settings
  - Go to the action filters, select the granular application control actions, then the applications that can support selected granular application control actions will be filtered out.
  - Select the applications that need actions set.
  - Go to Action, select the actions that apply to the selected application.
- **Option 2:** Single application settings
  - Select one application that needs an action.
  - Select an action from the application action list, and apply it.
- **Allow**—User accounts can use the application normally. Application Control events are recorded if the administrator enables that setting. (See [Application Control Settings](#) for details.)
- **Block**—User accounts cannot use this application. The network packets identified as part of this application will not be delivered. Application Control events can be recorded if the settings is enabled. (See [Application Control Settings on page 5-8](#) for details.) A log entry can also be created for this event.
- **Scheduling**—Select the time object for the protocol for which you want to apply the action. To select all the protocols of a group, click the check box for the group. The group does not need to be expanded for you to select all protocols in a group. (Restricted days and hours are defined at **Administration > IWSVA Configuration > Schedule Time**. (See [Scheduled Times on page 14-14](#) for details.) Click **Save** to apply the filtering action to the selected protocols.

---

**Note:** Settings will take effect after the HTTP service is restarted.

---

- **Notes**—Use to create policy notes, for example, to summarize the intent or justification for the policy. It can serve as a simple reminder or as a communication to others who could later administer this feature.
- Click **Finish** at the end of the rules list to return to the policy list.
- In the policy list, check the check box by the appropriate policy name(s) and click **Deploy Policies** when you are ready for the policy/policies to be deployed.

## Application Control Settings

Administrators can configure the following setting:

- Selecting the time interval for the violation log record (Default: 5 minutes)

---

**Note:** If the Application Control feature is not enabled, no logs are recorded and the Dashboard's Application Bandwidth (**Application Control > Settings**) will not display data.

---

### To configure the Application Control settings:

1. Go to **Application Control > Settings**.
2. Select one or more of the following by checking the check box:
  - **Log Application Control events for bandwidth statistic** — Selecting this option allows you to monitor and report all application activity that is allowed by the Application Control policies. (Logging activity is normally turned off by default.)
  - **Logging interval XX seconds** — Changing this option defines when to write to an application log record. For example, the default interval is 300 seconds (five minutes). No matter how many times one client accesses the same application in that five-minute interval, there will be only one log entry.

A user accessing the Internet using one of the tracked applications may create many sessions in a very short time. In order to prevent a flooding of events into the log database, this option can limit how often one event record is written for the activity. This limitation technique keeps the violation log from becoming too large and affecting performance. Admins may change the logging interval if they want to record to the violation log more frequently or less frequently.

3. Click **Save**.

## Traffic Monitoring Overview

Traffic Monitoring combines the HTTP and Application Connections traffic to show:

- Application Bandwidth
- Top blocked applications
- Top allowed applications
- Top policy enforcement - Application Control

Application Control can be enabled in Proxy mode, Transparent Bridge Mode, and Transparent Bridge Mode - High Availability.

---

**Note:** Traffic monitoring statistics will only display if the Application Control feature is enabled at **Application Control > Policies**.

---

---

**Note:** On the Dashboard, time is measured as follows:  
Last 1 Hour: From current time to current time - 60 minutes.  
Last 1 Day: From current time to current time - 24 hours

---

Traffic Monitoring combines the HTTP and Application Connections traffic to show the following data:

- **Application Bandwidth**—Shows the traffic trend of bandwidth (kbps) by Application usage for a specified range of time. Default time period: Last 1 Day. This widget display bandwidth in/out information based on IP addresses. Mouse-over a point on a colored lines to display details for specific interfaces. Data is real-time data, but the widget itself also accumulates data. The average value calculation is based on the same time period from the previous day. For example, if the current value is 10:05, then the corresponding average value is calculated using the last seven day's values from the same time. You can refresh the data manually by clicking the Refresh Dashboard icon in the upper right corner of the page.
- **Top Blocked Applications**—Shows the application categories being blocked the most for a specified range of time to provide high-level view of potential security, bandwidth, and productivity problems. Defaults: Top 5, Last 1 Day

- **Payload**—This is a dynamic display that can have two graphs: one for FTP and the other for HTTP(S). For FTP, the connection measured is the session for both commands and data. For HTTP(S), the connection measured is the session for both requests and responses. Default: Last 1 Day
- **Top Allowed Applications**—Shows the total number of access instances for the top allowed applications within a specific period of time.

**Note:** Other statistics about bandwidth and users are available at **Report > Internet Access > Top N Applications Visited Report > Bandwidth > Top N Applications by Bandwidth Report > Policy Enforcement > Top N Applications Blocked**.

## Notification for Denying HTTP/HTTPS Access with Application Control

IWSVA notifies users when an previously established Application Control policy has denied access to an unauthorized website. You can use the default notification to message users, or create a customized message of your own.

**To modify the default HTTP/HTTPS Application Control notification page:**

1. Go to **Notifications > HTTP/HTTPS Access Denied by Application Control**.

The following screen appears.

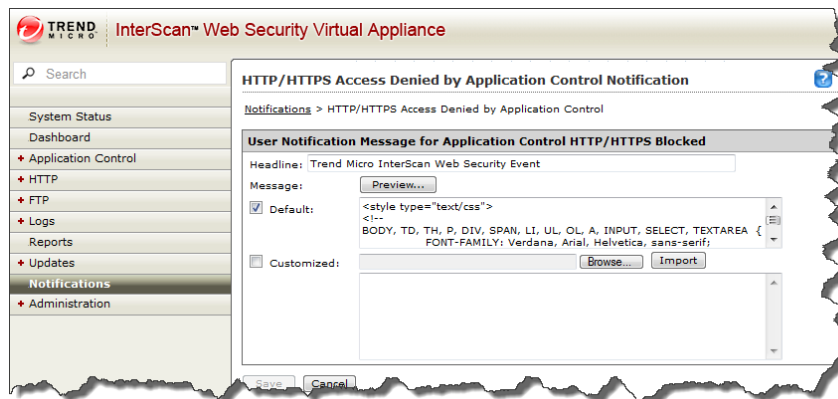

2. Copy the default HTML code used for the default notification and modify it with an HTML editor.
3. Save the edited content and message.
4. Click **Customized** and Browse for the HTML file you modified.
5. Click **Import**.
6. Check the notification's appearance by clicking **Preview**.
7. Modify if necessary.





# Chapter 6

## HTTP Configuration

Before you start using InterScan Web Security Virtual Appliance (IWSVA) to scan for malicious HTTP/HTTPS downloads, filter or block URLs, and apply access quotas for your clients, you need to configure some HTTP settings that control the HTTP traffic flow. IWSVA can be used in conjunction with another proxy server on your network; alternatively, you can configure IWSVA to use its native proxy.

---

**Note:** - To enable and configure WCCP, see [Network Configuration and Load Handling on page 6-11](#) and your Cisco product documentation.  
- To enable and configure Full Transparency (Transparent Bridge mode), see [Network Configuration and Load Handling on page 6-11](#).

---

Topics in this chapter include the following:

- [Enabling the HTTP/HTTPS Traffic Flow starting on page 6-2](#)
- [Specifying a Proxy Configuration and Related Settings starting on page 6-2](#)
- [Network Configuration and Load Handling starting on page 6-11](#)
- [Configuring Internet Access Control Settings starting on page 6-12](#)

## Enabling the HTTP/HTTPS Traffic Flow

The deployment mode is originally configured with the IWSVA Deployment Wizard. If you would like to change the deployment mode after the installation, you can use the **Administration > Deployment Wizard** to make the changes.

### To enable or disable the HTTP/HTTPS traffic flow through IWSVA:

1. Select **System Status** on the main menu.
2. Select one of the following:
  - If HTTP(s) traffic is turned off, click the **Turn On** link to enable it.
  - If HTTP(s) traffic is turned on, click the **Turn Off** link to disable it.

When HTTP/HTTPS traffic is turned off, your clients cannot access Web sites or any other services carried through HTTP/HTTPS.

## Specifying a Proxy Configuration and Related Settings

If you would like to change the deployment mode after the installation, you can use the **Administration > Deployment Wizard** to make changes.

- **Transparent bridge**—IWSVA acts as a Layer 2 network bridge between the devices it is deployed between and transparently scans HTTP, HTTPS, and FTP traffic between the clients and external services. No configuration changes to the network devices are required. Transparent bridge settings apply to both HTTP and FTP traffic, and if selected, FTP proxy settings are disabled. By default, SSL (HTTPS) traffic is passed through IWSVA, but not scanned. To allow IWSVA to scan SSL-encrypted traffic, you can configure HTTPS decryption policies to decrypt the content before scanning.

If the clients and IWSVA are in the same segment, no configuration is required.

Otherwise, see the following list for mixed segment configuration considerations.

If the network device and IWSVA device are on different network segments, use the IWSVA routing table to point IWSVA to the device. Requires two NICs.

- **Transparent bridge - high availability** — Requires a minimum of four NICs.
- **Forward Proxy**—This configuration is used to protect clients from receiving malicious HTTP/HTTPS/FTP-borne risks from a server. This is the most common configuration, and the typical use case is to protect Web users on your network from receiving malicious Internet downloads. IWSVA and the clients that it protects are typically in the same LAN.
- **Reverse proxy**—This configuration is used to protect Web servers from attacks or malware introduced by public or private users.
- **ICAP**—Choose this topology if you have an ICAP client on the network and you want it to pass traffic to IWSVA for scanning. IWSVA acts as an ICAP server.
- **Simple Transparency**—An L4 switch is set up to direct HTTP/FTP traffic to IWSVA. IPv6 support is not available with this option.
- **WCCP**—The WCCP configuration allows customers that have WCCP enabled routers and switches to redirect Web and FTP traffic to IWSVA to create a high-performance scalable and redundant architecture.

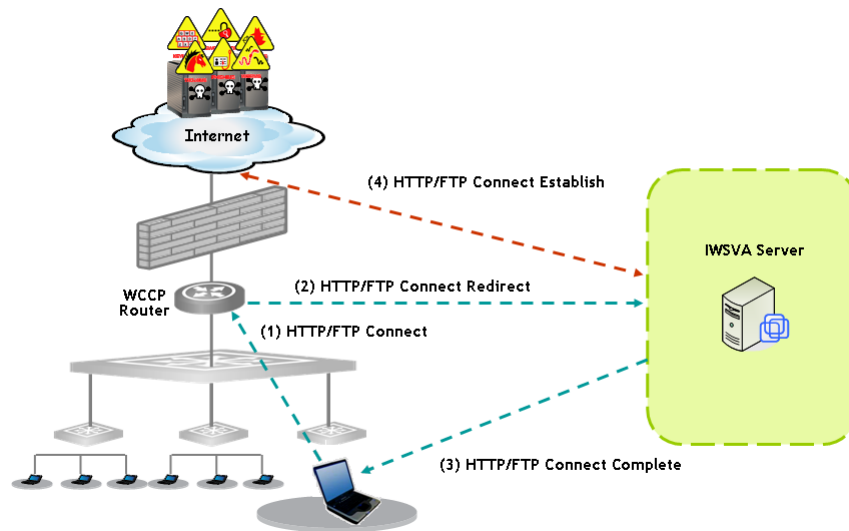

FIGURE 6-1. WCCP configuration and Web and FTP traffic

## Proxy Configurations

There are several types of proxy configurations:

- No upstream proxy (stand-alone mode)
- Upstream proxy (dependent mode)
- Simple transparency
- Reverse proxy
- WCCP

### No Upstream Proxy (Stand-alone Mode)

The simplest configuration is to install IWSVA in stand-alone mode, with no upstream proxy. In this case, IWSVA acts as a proxy server for the clients. The advantages of this configuration are its relative simplicity and that there is no need for a separate proxy server. A drawback of a forward proxy in stand-alone mode is that each client must configure the IWSVA device as their proxy server in their browser's Internet connection settings. This requires cooperation from your network users, and also makes it possible for users to exempt themselves from your organization's security policies by reconfiguring their Internet connection settings.



**FIGURE 6-2.** Forward, no upstream proxy

---

**Note:** If you configure IWSVA to work in stand-alone mode, each client on your network needs to configure Internet connection settings to use the IWSVA device and port (default 8080) as their proxy server.

---

**To configure a stand-alone installation:**

1. Click **Administration > Deployment Wizard** from the main menu.  
The Deployment Wizard displays.
2. Ensure that **Forward proxy mode** is selected, can click **Next**.
3. Verify that **Enable upstream proxy** is not selected.
4. Click **Next** until the Submit button displays. Click **Submit**. Click **Close**.

**Upstream Proxy (Dependent Mode)**

IWSVA can be configured to work in conjunction with another proxy server on your network. In this configuration, IWSVA passes requests from clients to another proxy server, which forwards the requests to the requested server.

Like the stand-alone mode, the dependent mode proxy configuration also requires client users to configure the IWSVA device as their proxy server in their Internet connection settings. One benefit of using an upstream proxy is improved performance through content caching on the upstream proxy server. IWSVA only performs content caching in forward proxy mode (if enabled.) When enabled, IWSVA performs content caching, or if another cache server is available, it could be configured for content caching. For other modes or if content caching is not enabled in Forward Proxy mode, every client request needs to contact the Internet server to retrieve the content. When using an upstream proxy, pages cached on the proxy server are served more quickly.

**Note:** If IWSVA is configured to operate in upstream proxy mode with a designated proxy server, Trend Micro recommends that the proxy settings for Updates also be configured to the same designated proxy server (see [Proxy Settings for Updates on page 4-4](#)). Certain types of update events utilize the Updates proxy settings to retrieve important information. If proxy settings are not configured properly, IWSVA will not be able to access the Internet for these services.

---



**FIGURE 6-3. Forward, upstream proxy**

**Note:** When IWSVA is configured in HTTP Forward Proxy mode with Upstream Proxy enabled, pharming sites cannot be effectively blocked.

When you configure IWSVA to work in Forward Proxy mode and enable Upstream Proxy, the Server IP White List will not take effect. Content from servers that you configure on the Server IP White List still will be scanned or filtered.

---

**To configure IWSVA to work with an upstream proxy:**

1. Click **Administration > Deployment Wizard** from the main menu.  
The Deployment Wizard displays.
2. Ensure that **Forward proxy mode** is selected, can click **Next**.
3. Check **Enable upstream proxy** and enter the IP address or host name of the upstream **Proxy server**, and the **Port number**.
4. Click **Next** until the Submit button displays. Click **Submit**. Click **Close**.

**Transparent Proxy**

*Transparency* is the functionality whereby client users do not need to change their Internet connection's proxy settings to work in conjunction with IWSVA. Transparency is accomplished with a Layer 4 switch that redirects HTTP packets to a proxy server, which then forwards the packets to the requested server.

IWSVA supports a “simple” type transparency. Simple transparency is supported by most Layer 4 switches. While it is compatible with a wide variety of network hardware from different manufacturers, configuring simple transparency does impose several limitations:

- When using simple transparency, the User Identification method to define policies is limited to IP address and/or host name; configuring policies based on LDAP is not possible.
- FTP over HTTP is not available; thus, links to ftp:// URLs might not work if your firewall settings do not allow FTP connections. Alternatively, links to ftp:// URLs might work, but the files are not scanned.
- Simple transparency is not compatible with some older Web browsers when their HTTP requests do not include information about the host.
- Do not use any source NAT (IP masquerade) downstream of IWSVA, because IWSVA uses the IP address of the client to scan and clean the malicious traffic.

The benefit of enabling transparency is that the clients' HTTP/HTTPS requests can be processed and scanned by IWSVA without any client configuration changes. This is more convenient for your end users, and prevents clients from exempting themselves from security policies by simply changing their Internet connection settings.



**FIGURE 6-4. Forward proxy with transparency**

---

**Note:** In simple transparency mode, IWSVA does not accept SSL (HTTPS) traffic. Configure the router not to redirect port 443 traffic to IWSVA.

If you configure IWSVA in simple transparency mode and the IWSVA server is connected to a layer-4 switch, you should set the HTTP listening port to 80 and enable PING on the data interface to allow users to access the Internet through IWSVA.

---

**To configure simple transparency:**

1. Click **Administration > Deployment Wizard** from the main menu.  
The Deployment Wizard displays.
2. Check **Simple Transparency mode** and click **Next**.
3. Change the **HTTP Listening port** to the same port that the Layer 4 switch is configured to use.
4. Click **Next** until the Submit button displays. Click **Submit**. Click **Close**.



## Reverse Proxy

IWSVA can be used to scan content that clients upload to a Web server. When IWSVA is installed using either the forward or reverse proxy scan configuration, traffic in both directions is scanned (uploading and downloading).

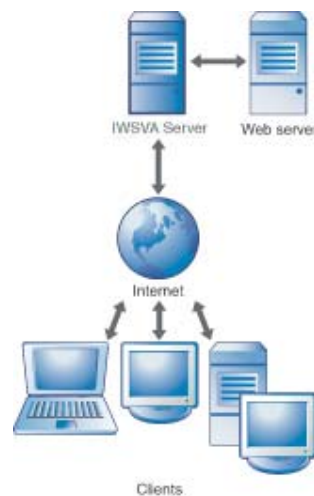

**FIGURE 6-5.** Reverse proxy protects Web server from clients

### To configure IWSVA as a reverse proxy:

1. Click **Administration > Deployment Wizard** from the main menu. The Deployment Wizard displays.
2. Select **Reverse proxy** mode and click **Next**.
3. Enter the **HTTP Listening Port** number, the IP address or host name of the **Protected server**.
4. If you want to enable HTTPS access, check **Enable SSL Port** and enter the **Port Number**.
5. Click **Next** until the Submit button displays. Click **Submit**. Click **Close**.

---

**Note:** If communication with your internal Web servers is through SSL, you must configure the HTTPS port(s). For more information, see [HTTPS Ports starting on page 6-16](#).

In reverse proxy mode, IWSVA tunnels HTTPS traffic. HTTPS decryption is not supported in Reverse Proxy Mode.

---

To complete your reverse proxy configuration, the IWSVA device's IP address must be registered in the DNS as the host name of the Web server that the reverse proxy is protecting. In this way, the IWSVA device appears to be the Web server, as far as the clients are concerned.

## Proxy-related Settings

In addition to specifying the type of proxy configuration you want, you can also set the following parameters for the configuration:

- HTTP listening port
- Anonymous FTP logon over HTTP email address

### HTTP Listening Port

If you enable HTTP scanning, be sure to specify the appropriate listening port number of a given HTTP handler so the traffic will go through.

---

**Note:** It is not necessary to configure an HTTP Listening Port in Transparent Bridge mode.

---

#### To configure the listening port number:

1. Open the IWSVA Web console and click **Administration > Deployment Wizard**.
2. Select your mode and click **Next**.
3. In the **HTTP Listening port** text box, type the port number (default values are 1344 for ICAP and 8080 for HTTP Proxy).
4. Click **Save**.

---

**Note:** IWSVA handles HTTPS connections differently from HTTP connections. Because the data is encrypted, you can configure HTTPS decryption policies to decrypt the content which can then traverse filtering and scanning policies as “normal” HTTP traffic. IWSVA examines the initial CONNECT request, and rejects it if it does not match the set parameters (such as the target URL is on the Block List or contained in the Phish pattern file, or the port number used is not defined in the `HttpsConnectACL.ini` file).

---

## Anonymous FTP Logon Over HTTP Email Address

FTP over HTTP enables users to access hyper links to ftp:// URLs in Web pages and enter a URL starting with ftp:// in the address bar of their browser. If the user omits the user name when accessing this type of URL, anonymous login is used, and the user's email address is conventionally used as a password string that is passed to the FTP server.

### To configure the email address to use for anonymous FTP logon over HTTP:

1. Select **Administration > Deployment Wizard** from the main menu.
2. Select **Simple Transparency mode**.
3. Type the **Email address to use** for an anonymous FTP log on.
4. Click **Save**.

## Network Configuration and Load Handling

The number of users supported by each IWSVA instance depends on the hardware where IWSVA is installed, the average number of concurrent sessions used per user, the bandwidth used by each users' sessions, and the percentage of the user population that is using the Internet simultaneously. In general, the more powerful the IWSVA server platform, the larger IWSVA's capacity will be.

In general, a two processor dual core server with 4GB of memory and fast hard disk drives will be able to support up to 4000 users. A two processor quad core server with 8GB of memory and fast hard disk drives will be able to support up to 9500 users.

Trend Micro's general capacity planning rules make the assumption that each user opens an average of two concurrent sessions and approximately 20 percent of the user population is actively accessing the Internet.

---

**Note:** For more information on capacity sizing, refer to the IWSVA Sizing Guide.

---

You can install IWSVA on the network in the following modes:

- **Transparent Bridge**—Run a cable from the external (Internet-facing) network device to an IWSVA external port, and from an IWSVA internal port, to an internal network device.
- **Forward Proxy**—Run a cable from the interface configured in the CLI to the internal network device.
- **ICAP**—Connect IWSVA to the ICAP client using the interface configured in the CLI.
- **WCCP**—Trend Micro recommends using the following Cisco IOS versions when configuring WCCP with IWSVA:
  - 12.2(0) to 12.2(22). Avoid using releases 23 and above within the 12.2 family
  - 12.3(10) and above. Avoid using releases 0-9 in the 12.3 family
  - IOS 12.4(15)T3 or later should be used

After setting up the IWSVA server, open the IWSVA Web console and click **Administration > Deployment Wizard** to set the corresponding IWSVA scan mode.

## Configuring Internet Access Control Settings

IWSVA includes several configurations to control your clients' HTTP/HTTPS access. These settings are separate from any scanning or URL filtering policies that you might configure for your user base.

- HTTP access can be selectively enabled for client users with a given IP address, IP range, or IP mask.
- To improve performance when client users request content from “trusted” sites, scanning, URL filtering, and URL blocking can be disabled for servers with a given IP address, or servers within a given IP range or IP mask.

- HTTP and HTTPS requests to ports or port ranges can be selectively allowed or denied for all users whose Internet access passes through IWSVA. This feature is convenient if you want to prevent certain types of Internet transfers. In addition, you can configure HTTPS decryption policies to decrypt HTTPS traffic for scanning.

## Identifying Clients and Servers

For controlling client Web access or configuring servers as trusted, there are three ways to identify the client or server:

- IP address: a single IP address, for example, 123.123.123.12
- IP range: clients that fall within a contiguous range of IP addresses, for example, from 123.123.123.12 to 123.123.123.15
- IP mask: a single client within a specified subnet, for example, entering IP = 192.168.0.1 and Mask = 255.255.255.0 identifies all machines in the 192.168.0.x subnet. Alternatively, the Mask can be specified as a number of bits (0 to 32)

## Client IP

In addition to the default setting that allows all clients on your network to access the IWSVA proxy, IWSVA can be configured to allow HTTP access only to those clients that you explicitly specify. If your organization does not allow everyone on your network to access the Internet, this is a convenient way to block HTTP access by default.

Client Access Control supports both IPv4 and IPv6 clients. When selecting policies, both IPv4 and IPv6 policies will appear. Client Access Control accepts a single IPv6 address, an IPv6 range, or an IPv6 mask similar to what has been supported with IPv4.

### To allow HTTP access based on client IP:

1. Select **HTTP > Configuration > Access Control Settings** from the main menu.

In transparent bridge mode, the destination and HTTPS ports are not available; therefore, when in this mode the **Destination Ports** and **HTTPS Ports** tabs are not present in the **Internet Access Control** screen.

2. Ensure that the **Client IP** tab is active.
3. Check **Enable HTTP Access Based On Client IP**.

4. Select the option that describes how clients are allowed HTTP access—either **IP/Hostname**, **IP range**, or **IP Subset**.

---

**Note:** If you specify a single IP address and then an IP address range containing the single IP address, the IP address range is negated if a user attempts to access a URL at the single IP address.

---

For more information about identifying the clients, see [Identifying Clients and Servers starting on page 6-13](#).

To delete a client IP or IP range, click the corresponding **Delete** icon next to it.

5. Type a descriptive name in the **Description** field. (40 characters maximum)
6. Click **Add**.

The client IP that you have configured is added to the list at the bottom of the **Client IP** tab. Access control settings are evaluated according to the order they appear in the list at the bottom of the **Client IP** tab.

7. Click **Save**.

## Approved Server IP List

To maximize the performance of your network, you can configure IWSVA to skip scanning and filtering content from specific servers. For example, if you are protecting your intranet server with IWSVA in a reverse proxy configuration, you can be reasonably assured that its content is safe and you might want to consider adding your intranet servers to the Server IP White List.

After configuring the IP addresses or ranges of trusted servers, the configurations are saved to the `ServerIPWhiteList.ini` configuration file. Overlapping IP ranges are not allowed.

---

**WARNING!** Content from servers that you configure on the Server IP white list is not scanned or filtered. Trend Micro recommends adding only those servers over which you have close control of the contents.

---

In ICAP mode, the server IP white list is only applied to RESPMOD requests. REQMOD activities (such as URL filtering, Webmail upload scanning, and URL blocking) cannot be bypassed by the server IP white list for ICAP installations.

Server Access Control supports both IPv4 and IPv6 clients. When selecting policies, both IPv4 and IPv6 policies will appear. Server Access Control accepts a single IPv6 address, an IPv6 range, or an IPv6 mask similar to what has been supported with IPv4.

**To add servers to the Server IP White List:**

1. Select **HTTP > Configuration > Access Control Settings** from the main menu.
2. Ensure that **Approved Server IP List** tab is active.
3. Check the way you want to specify trusted servers whose content is not scanned or filtered—either **IP/Hostname**, **IP range**, or **IP Subset**.

For more information about identifying the clients, see [Identifying Clients and Servers starting on page 6-13](#).

4. Type a descriptive name in the **Description** field. (40 characters maximum)
5. Click **Add**.

The trusted servers that you have configured appears at the bottom of the **Approved Server IP List** tab.

To delete a trusted server or range, click the corresponding **Delete** icon next to it.

6. Access control settings are evaluated according to the order they appear in the list at the bottom of the **Approved Server IP List** tab.
7. Click **Save**.

## Destination Port Restrictions

IWSVA can restrict the destination server ports to which clients can connect. HTTP requests to a denied port are not forwarded. This approach can lock down your server and prevent clients from using services such as streaming media applications that contravene your network's security policies by denying access to the ports used by these services.

The default post-install configuration is to deny all requests, except for those to ports 80 (HTTP), 70 (Gopher), 210 (TCP), 21 (FTP), 443 (SSL), 563 (NNTPS) and 1025 to 65535.

---

**Note:** To enable FTP over HTTP connections for clients to open FTP links in Web pages, IWSVA must be able to open a command connection to the FTP server on port 21. This requires allowing access to port 21 on the HTTP access control settings.

---

For a list of ports used by various applications and services, see <http://www.iana.org/assignments/port-numbers>.

**To restrict the destination ports to which a client can connect:**

1. Select **HTTP > Configuration > Access Control Settings** from the main menu.
2. Ensure that the **Destination Ports** tab is activated.
3. Choose the **Action** to perform. Choose **Deny** to prevent connections to a specific port or port range on a destination server, or **Allow** to permit connections to a specific port or port range.
4. Check either **Port** or **Port Range** and then enter the corresponding port(s).
5. Type a descriptive name in the **Description** field. (40 characters maximum)
6. Click **Add**. The destination port restrictions are added to the list at the bottom of the **Destination Ports** tab.

To delete a destination port or port range to which you allow or deny access, click the **Delete** icon next to it.

7. Access control settings are evaluated according to the order they appear in the list at the bottom of the **Destination Ports** tab.

To change the order that ports appear in the list, click the up or down arrows in the **Evaluation Order** column.

8. Click **Save**.

## HTTPS Ports

IWSVA can restrict which ports can be used for encrypted HTTP transactions. The default configuration is to allow only HTTPS connections on port 443 (the default HTTPS port) and 563 (the default port for encrypted news groups).



---

**Note:** If you need to access the Web console through HTTPS while connecting through IWSVA itself, allow access to the IWSVA secure console port number (8443 by default).

---

**To restrict the ports that can be used to tunnel encrypted HTTP transactions:**

1. Select **HTTP > Configuration > Access Control Settings** from the main menu.
2. Make the **HTTPS Ports** tab active.
3. Choose to either **Deny** or **Allow** the **HTTPS Ports**.
4. Check either **Port** or **Port Range** and then enter the corresponding port(s).
5. Type a descriptive name in the **Description** field (40 characters maximum.)
6. Click **Add**. The destination port restrictions appear at the bottom of the **HTTPS Ports** tab.

To delete any HTTPS port access restrictions that you might have configured, click the **Delete** icon next to the port or port range to remove.

7. Access control settings are evaluated according to the order they appear in the list at the bottom of the **HTTPS Ports** tab. To change the order that ports are displayed in the list, click the up or down arrows in the **Evaluation Order** column.
8. Click **Save**.



# Chapter 7

## Policies and User Identification Method

InterScan Web Security Virtual Appliance (IWSVA) is able to apply different HTTP virus scanning, HTTPS decryption, Applets and ActiveX security, URL filtering, Application Control and access quota policies to different individuals or groups on your network. In this way, security policies can be customized based on your business need to handle potentially malicious code, view certain categories of Web content or to prevent the consumption of excessive bandwidth for Web browsing.

Topics in this chapter include the following:

- [How Policies Work on page 7-2](#)
- [Default Global and Guest Policies on page 7-4](#)
- [Deploying Policies on page 7-6](#)
- [Configuring the User Identification Method on page 7-6](#)
- [Login Accounts on page 7-20](#)

## How Policies Work

Different security settings can be configured for different users or groups on your network, based on the type of files or Internet resources they need to access. IWSVA policies can be applied to IPv6 clients and servers, much like the HTTP(s) scan policies, URL filtering policies, and so on. All user identification methods function in the IPv6 environment (client IP address is IPv6) as well. Client and server access control should support IPv6 hosts. The following are some examples of the practical applications of different security policies:

- **Virus scanning:** Your organization's acceptable user policy might generally prohibit clients from downloading audio or video files. However, there might be some groups within your company who have a legitimate business purpose for receiving these types of files. By configuring several virus scanning policies, you can apply different file blocking rules in HTTP virus scanning policies for different groups within your company.
- **Applets and ActiveX security:** To prevent clients from running applets that could intercept sensitive information and transmit it over the Internet, you might want to configure a policy for most of your company that prevents applets from connecting to their originating servers. However, if there are users in your company who have a legitimate business purpose to run these sorts of applets (for example, to get quotations through a Java applet stock price ticker), another policy could be configured and applied to a sub-set of your client base.
- **URL filtering:** To discourage your employees from engaging in non-work-related Web surfing, you might want to configure a Global Policy that blocks access to Web sites in the "gambling" category. However, you might need to configure another policy that permits access to these types of sites so your sales organization can learn more about prospects in the gaming industry. In addition to selected pre-defined categories, you can also create new Web categories to apply to URL filtering policies.
- **HTTPS decryption:** To scan encrypted content over HTTPS connections, you can configure HTTPS decryption policies based on the type of sites accessed. Once decrypted, the content can traverse through filtering and scanning policies on IWSVA as "normal" HTTP traffic. HTTPS decryption policies prevent security risks embedded in HTTPS traffic.

Account fields should support IPv6 addresses. You can define one rule for any IPv6 host, and this policy rule is triggered when the client accesses the HTTPS sites through IWSVA.

- When selecting policies, both IPv4 and IPv6 policies will appear.
- In the Account field, acceptable account entries include a single IPv6 address, an IPv6 range, or an IPv6 mask similar to what has been supported with IPv4.
- **Access quotas:** IWSVA allows you to configure access quota policies to limit the volume of files that clients can download during the course of a day, week, and month, to control the amount of bandwidth that your organization uses. For those employees who have a legitimate business need to browse the Internet extensively, you can configure another policy granting them unlimited Internet access.
- **Application Control:** Using a security technology that automates the discovery of popular Internet-based applications, Application Control policies allow administrators to control the use of those applications. Application Control policies allow granular control of the functionality within the supported Internet-based application categories. IWSVA allows more than a simple allow-or-block option, since many companies have found specific functions of these applications are effective for conducting business.
- **HTTP Inspection:** HTTP Inspection allows administrators to identify behavior and filter web traffic according to HTTP methods, URLs, and headers. It also allows them to create filters or use default filters to identify web traffic, as well as import and export filters. After the traffic is identified, IWSVA can control it according to policy settings that determine the appropriate actions for specific traffic.
- IWSVA enables you to block communication provided by certain Instant Message (IM) protocols and certain authentication connection protocols.
- IWSVA provides the flexibility that allows you to configure and apply approved URL or file name lists on a per-policy bases.

In addition to being able to define custom policies that apply to specific users, IWSVA is pre-configured with two default policies, the “Global Policy” and the “Guest Policy,” to provide a baseline level of HTTP virus scanning, Applets and ActiveX security, and URL filtering.

---

**Note:** IWSVA supports the Guest Policy only with Captive Portal and LDAP enabled.

---

## Default Global and Guest Policies

IWSVA has default global and guest policies for the following activities: HTTPS decryption, Advanced Threat Protection, Applets and Active X, URL Filtering, and HTTP Inspection. Application Control has a default global policy.

- **Global Policy**—For all clients who access through IWSVA.
- **Guest Policy**—For those clients, typically temporary workers, contractors, and technicians who proxy through IWSVA using a special “guest access” option. Guest accounts are disabled by default; to enable a guest account go to **Administration > IWSVA Configuration > User Identification > Authentication Method > Captive Portal > Allow Guest Login** only after LDAP has been enabled. Go to [Enabling the Guest Account](#) starting on page 7-5.

---

**Note:** The guest policy is a feature that is available when the administrator has configured IWSVA to use the LDAP “User/Group name authentication” feature as the user identification method. Administrators can opt to provide one “Guest Access” button to users who do not have accounts within the organization's directory servers, (such as contract personnel or visiting vendors) so they can still access the Web.

---

The Global Application Control policy is the default policy.

- **Enable policy**—Enables or disables the individual policy; the global Application Control setting overrides the specifications of an individual policy.
- **IP Range**—Use to specify the range of IP addresses (IPv4 and/or IPv6) that will be affected by the Application Control policy.
- **IP Address/(User or Group possible)**—Use to specify the single IP address (IPv4 and/or IPv6) that will be affected by the URL filtering policy.

---

**Note:** The options on this page depend upon the user identification method that you are using—either IP address or User/group name authentication, if you enable LDAP authentication. For more information about configuring the user identification method and defining the scope of a policy, see [User Identification and URL Filtering Policies](#).

---

- **Add**—Click to add a single or range of IP addresses to the list of addresses that will be affected by the Application Control policy.

**To add an Application Control policy:**

1. Go to **Application Control > Policies**.
2. Click the **Add** link above the policy list.
3. Type a descriptive policy name. This will help you remember the policy.
4. You can also create a new policy based on the settings of an existing policy by clicking the “Copy from existing policy” option and selecting a policy from the drop-down list.
5. Type a single IP address or a range of IP addresses to signify the users affected. Alternatively, choose the user or group name if LDAP integration has been set up.
6. Click **Add** to move the newly entered IP address, range, or user/group name to the Type & Identification table.
7. Click the **Enable Policy** check box at the top of the screen to enable the policy after it is created.
8. Click **Next** to continue.
9. Specify the rules of the policy that apply to the specified accounts.

## About the Guest Policy

The Guest Policy is the only policy applied to guest users.

For more information about enabling the “User/group name authentication” user identification method, see [User/Group Name Authentication starting on page 7-10](#).

## Enabling the Guest Account

To enable Internet connectivity to network users who are not in the LDAP directory and apply guest policies, enable the settings at **User Identification > Authentication Method**.

**To enable the guest account:**

1. From the **User Identification** page, select the Captive Portal (Custom Authentication page delivered by IWSVA to browser) option and the “Allow Guest Access” check boxes. (Unauthenticated users will always see the Captive Portal page).”
2. Click **Save**.

## Policy Queries

When a new policy is added to the client, administrators might find that the policy is not functioning correctly. You might also like to determine which policy is currently functioning on the client server. The policy query feature is designed to help you discover how many policies are currently functioning on a client.

Using the policy queries is as simple as entering a client's IP address, or a username in the search box and clicking the Search icon.

After clicking the Search icon IWSVA provides the query result grouped by the policy type and sorted by the order. This feature is best suited for administrators who need an overview or summary of the policies used in IWSVA, and a list of those policies that can be found in the violation logs.

Every policy has a "notes" field, and administrators can use the field to store detailed information about the policy.

## Deploying Policies

After configuring a policy, the settings are written to the database after you click **Save**. Clicking **Deploy Policies** applies the new policy configuration immediately. Otherwise, the policy changes go into effect when IWSVA reads the information from the database after the time intervals specified under **Policy Deployment Settings (in minutes)** on the **Administration > IWSVA Configuration > Policy Deployment** screen.

---

**Note:** When policies are being applied, either after the cache expiration interval or from clicking **Deploy Policies**, HTTP(S) and FTP connections are interrupted for a short time (about ten seconds).

---

## Configuring the User Identification Method

You need to configure how IWSVA identifies clients to define the scope of HTTP virus scanning, URL filtering, Applets and ActiveX security, Application Control, and access quota policies. Your choice of user identification method also determines how security events are traced to the affected systems in the log files and reports.



IWSVA provides three user identification methods to identify clients and apply the appropriate policy:

- IP address (default option)
- User/Group name authentication (LDAP)

The following table lists the different user identification method IWSVA supports in various deployment modes:

**TABLE 7-1. Supported User Identification Method in Different Deployment Modes**

|                       | <b>IP ADDRESS</b>               | <b>USER/GROUP NAME AUTHENTICATION</b>                                                                                                                                                                                                                        |
|-----------------------|---------------------------------|--------------------------------------------------------------------------------------------------------------------------------------------------------------------------------------------------------------------------------------------------------------|
| Bridge Mode           | Yes                             | Yes                                                                                                                                                                                                                                                          |
| Standalone/ Dependant | Yes                             | Yes                                                                                                                                                                                                                                                          |
| WCCP                  | Yes                             | Yes                                                                                                                                                                                                                                                          |
| Simple Transparency   | Yes (if source NAT is disabled) | No<br><b>Note:</b> Standard Authentication and Captive Portal do work, but if an end-user inputs a user name and password, others will pass authentication and use the same IWSVA record for the same user. Enable Captive Portal and Cookie Mode work well. |
| Reverse Mode          | Yes                             | No                                                                                                                                                                                                                                                           |

**TABLE 7-1. Supported User Identification Method in Different Deployment Modes (Continued) (Continued)**

|      | <b>IP ADDRESS</b> | <b>USER/GROUP NAME AUTHENTICATION</b>                                                                          |
|------|-------------------|----------------------------------------------------------------------------------------------------------------|
| ICAP | Yes               | Yes<br><b>Note:</b> Only standard authentication is supported. Captive portal authentication is not supported. |

---

**Note:** For users connecting to an HTTP server with integrated Windows authentication through the IWSVA using Internet Explorer 6.0, make sure the **Use HTTP1.1 through proxy connections** option is selected in the **Tools > Internet Options > Advanced** screen for NTLM (NT LAN Manager) authentication to work properly.

---

## IP Address

The IP address is the default identification option and requires the following:

- Client IP addresses are not dynamically assigned through DHCP as DHCP will make the IP address identification less accurate as DHCP leases expire.
- Network address translation (NAT) is not performed on the network path between the affected system and IWSVA.

If the local network meets these conditions, you can configure IWSVA to use the IP address user identification method.

When using the IP address identification method, the scope of scanning policies is defined by defining a range of IP addresses, or a specific IP address, when adding or editing a policy.

**To enable the IP address user identification method:**

1. Select **Administration > IWSVA Configuration > User Identification | User Identification** from the main menu.
2. From the **User Identification** screen, select **None**.
3. Click **Save**.

## Client Registration Utility

The **Host name (modified HTTP headers)** user identification option requires that you run a Trend Micro-supplied program on each Windows client before clients connect to IWSVA and access the Internet. The program file is:

`register_user_agent_header.exe` and is located in the `/usr/iwss/bin` (IWSVA machine). An effective way to deploy this program to your clients is to invoke it from a logon script for the local Windows domain.

The program works by modifying a registry entry:

```
(HKEY_LOCAL_MACHINE\Software\Microsoft\Windows\CurrentVersion\Internet Settings\User Agent\Post Platform)
```

Internet Explorer includes that registry entry in the User-Agent HTTP header. You can find the identifying information logged under the **User ID** column in various log files. It alters Windows configuration values to include the MAC address of the client system and the machine name that made the HTTP requests. The MAC address is a unique and traceable identification method and the machine name is an additional and helpful identifier. For more information, refer to [Enabling MAC Address Client Identification](#) on page 13-42.

After running the `register_user_agent_header.exe` utility, a new registry value is created under the following key:

```
HKEY_LOCAL_MACHINE\SOFTWARE\Microsoft\Windows\CurrentVersion\Internet Settings\User Agent\Post Platform
```

The new registry value called `IWSS25:<host_name>/<MAC address>` is encrypted, where `<host_name>` and `<MAC address>` correspond to the client that ran the utility.

## User/Group Name Authentication

IWSVA can integrate with the following LDAP servers, and supports both the LDAP two and three protocols:

- Microsoft™ Active Directory for Windows Servers 2003 and 2008
- Linux™ OpenLDAP Directory 2.3.39
- Sun Java System Directory Server 5.2 (formerly Sun™ ONE Directory Server)

## LDAP Authentication Method

When you enable the “**User/group name authentication**” method, clients are required to enter their network logon credentials before accessing the Internet.

The following table shows which LDAP authentication methods can be used with each of the supported LDAP servers:

**TABLE 7-2. Authentication Methods for Supported LDAP Servers**

|                                                                           | <b>KERBEROS</b> | <b>SIMPLE AUTHENTICATION</b> | <b>NTLM</b> |
|---------------------------------------------------------------------------|-----------------|------------------------------|-------------|
| Microsoft Active Directory for Windows Servers 2003 and 2008              | yes             | no                           | yes         |
| Linux OpenLDAP 2.3.39                                                     | yes             | yes                          | no          |
| Sun Java System Directory Server 5.2 (formerly Sun™ ONE Directory Server) | no              | yes                          | no          |

---

**Note:** To use the Digest-MD5 authentication method with the Sun Java System Directory Server 5.2, all passwords must be stored as clear text in the LDAP directory.

For increased security protection, IWSVA uses the advanced authentication method (Kerberos or Digest-MD5) for all subsequent user logon authentications from IWSVA to the LDAP server.

---

## LDAP Communication Flows

When clients request Internet content, they are prompted to enter their network credentials. Advanced authentication uses a Kerberos server as a central secure password store. Therefore, the benefit of using Kerberos is that it provides a higher degree of security. After the client's credentials are authenticated with a Kerberos Server, a special encrypted "ticket" certified by the Kerberos server is used to access IWSVA and the Internet.

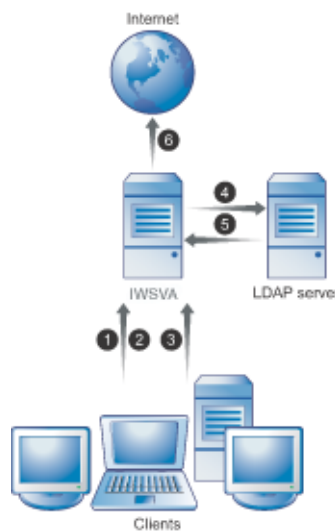

**FIGURE 7-1. LDAP Communication Flow Using Kerberos Authentication**

When User/group authentication is enabled in either forward proxy mode or transparent mode with Active Directory, you can take advantage of the automatic authentication feature provided in the Internet Explorer Web browser. With automatic authentication, clients already logged on the domain network can access the local Intranet without having to enter the logon information (such as the user name and password); that is, no password pop-up screen displays.

---

**Note:** You must configure IE settings to enable automatic authentication on each client computer. By default, automatic authentication is enabled in IE 7.0.

---

IWSVA supports Internet Explorer automatic authentication for the following authentication method:

- Single domain (LAN or 802.11)
- Global catalog enabled in a multi-domain environment (LAN or 802.11)

**To enable automatic authentication in IE:**

1. Open Internet Explorer on a client computer, click **Tools > Internet Options** and then click the **Security** tab.
2. Click **Local intranet** and click **Custom level. . .**
3. Select **Automatic logon only in Intranet zone** and click **OK**.
4. Click **Sites**, select **Automatically detect intranet network**, and click **Advanced**.
5. In the Intranet Network screen, type the IWSVA hostname and click **Add**.
6. Save the settings.

**To enable automatic authentication in Firefox:**

1. Open Firefox on a client computer and type “about:config” in the address field.
2. Type “ntlm” in the **Search** field.
3. Double-click **network.automatic-ntlm-auth.trusted-uris**.
4. A pop-up screen displays. Type the hostname of the IWSVA server and click **OK**.

---

**Note:** For other supported Web browsers and authentication methods not listed above, users will need to type the logon information in a pop-up screen.

---

## LDAP Authentication in Transparent Mode

Before configuring LDAP authentication on IWSVA deployed in transparent mode (bridge and WCCP), review the following criteria to ensure each item is fully met.

- A valid hostname must be assigned in the Deployment Wizard when configuring Transparent Bridge or WCCP modes. The same hostname must also be entered in the corporate DNS server.
- Ensure that the user ID cache is enabled, which is the default setting. This setting must be enabled before enabling transparent mode authentication. You can enable user ID cache using the `configure module ldap ipuser_cache enable` command in the CLI.

- By default, IWSVA keeps user ID cache information for up to 2 hours. To lower the cache timeout value, use the `configure module ldap ipuser_cache <interval>` command in the CLI to set a shorter cache interval.
- If authentication is enabled, IWSVA will block all non-browser applications trying to access the Internet. For example, the MSN application may try to access the Internet before the user has a chance to log in the IWSVA server. If this happens, the application will be blocked as the user has not successfully authenticated to IWSVA. You can perform one of the following:
  - a. Enable the Domain Controller or Windows client query. After enabling either of these options, no authentication is required because IWSVA obtains the username and domain name through domain controller or client query.
  - b. Bypass LDAP authentication for the application by adding the URLs that application accesses to “Global Trusted URLs.” The URLs in this list will bypass both authentication and content scanning.
  - c. Instruct users to open their Web browsers and get authenticated before starting up applications that need Internet access.
  - d. Add the IP address of the client machine to “LDAP authentication White List.” IP address in this list will bypass LDAP authentication.
- When User/group authentication is enabled in either forward proxy mode or transparent mode with Active Directory, you can take advantage of the automatic authentication feature provided in the Internet Explorer Web browser. With automatic authentication, clients already logged on to the domain network can access the local Intranet without having to enter the logon information (such as the user name and password); that is, no password pop-up screen displays.

---

**Note:** You must configure your IE settings to enable automatic authentication on each client computer. By default, automatic authentication is enabled in IE 7.0.

---

## Configuring LDAP Settings

If you want to use LDAP user/group names for authentication and policy configuration purposes, you must set IWSVA’s user identification feature to use your corporate LDAP server.

---

**Note:** If you want to apply the Guest Policy for those network users who are not in your LDAP directory, enable the guest account in the Authentication Method section. For more information about enabling the guest account see [Enabling the Guest Account starting on page 7-5](#).

---

**To configure IWSVA to use the user/group name authentication method:**

1. Select **Administration > IWSVA Configuration > User Identification | User Identification tab** from the main menu.
2. Enter the Domain name, Service Account, and Password of the LDAP server and click **Test Connection** to validate the LDAP connection.
3. Click **Save** to preserve your settings.

---

**Note:** In case future versions of Microsoft Active Directory modify the schema, IWSVA supports changing the attribute names that make up a user's distinguished name. If you're using either Microsoft Active Directory 2003 or 2008, you should select the **Default settings** option.

---

4. If you have multiple LDAP domains or multiple LDAP server types, choose Advanced (other or multiple LDAP servers).
5. Enter the LDAP Domain Name.  
  
Entering the LDAP server hostname's IP address is also acceptable, but FQDN format is recommended due to an incompatibility between Kerberos servers and identifying LDAP servers using their IP address.
6. When the LDAP server is a Microsoft Active Directory, "Auto Detect" will be available to detect and automatically fill the domain settings. Enter the "**Admin account**" and **Password** for a credential with at least read authority to the LDAP server. If the domain is *us.example.com*:
  - For Microsoft Active Directory, use the UserPrincipalName for the admin account, for example, *NT\_Logon\_ID@us.example.com*.
  - For OpenLDAP and the Sun Java System Directory Server 5.2, enter the Distinguished Name (DN) for the admin account (for example, *uid=LOGON\_ID,ou=People,dc=us,dc=example,dc=com*).



7. Enter the **Listening port number** used by the LDAP server that you have chosen (default = 389). If your network has multiple Active Directory servers and you have enabled the Global Catalog (GC) port, change the listening port to 3268.

---

**Note:** If you enable the Global Catalog in Active Directory, you might need to configure your firewall to allow communication through port 3268.

---

8. Enter the LDAP server's hostname using the Fully Qualified Domain Name (FQDN). Ensure the LDAP server's hostname IP address is also acceptable, but the FQDN format is recommended because of an incompatibility between the Kerberos servers and the identifying LDAP servers using their IP addresses.
9. Enter the **Base distinguished name** to specify from which level of the directory tree you want IWSVA to begin LDAP searches.

The base DN is derived from the company's DNS domain components; for example, LDAP server `us.example.com` would be entered as *DC=example, DC=com*.

If you are using Active Directory servers with the Global Catalog (GC) port enabled, use the root domain of the Global Catalog-enabled Active Directory; for example, use *dc=example,dc=com*.

10. Select the LDAP authentication method to use—either **Simple**, **Digest-MD5**, or **Kerberos**.

Additionally, configure the following parameters to use Advanced authentication:

- Default Realm
- Default Domain
- **KDC and Admin Server:** The hostname of the Kerberos key distribution server. If you are using Active Directory, this is typically the same host name as your Active Directory server.
- **KDC port number:** Default port = 88

When using NTLM to authenticate with KDC(s) on a different forest through Internet Explorer or using IWSVA to do referral chasing with Active Directory, Trend Micro recommends enabling “Use HTTP 1.1 through proxy connections.” This setting can be found on the Internet Explorer **Tools** menu > **Internet Options** > **Advanced** tab. Enabling this setting prevents Internet Explorer from cutting off the “Keep-Alive connection” setting. Note that using NTLM is only supported with Microsoft Active Directory.

11. Configure the **Authentication White List** to exempt hosts from the LDAP authentication process.

For example, if you have an application server that access the Internet and you want to permit its access without requiring the server to authenticate, you can include the server's IP address in the LDAP authentication white list.

IWSVA will only apply IP address-based policy settings and bypass user/group name checking.

IWSVA supports LDAP queries from IPv6 with similar behavior to that of IPv4. The LDAP client white list supports IPv6 addresses similar to that of IPv4 as well. The LDAP Authentication request dialog box supports IPv4 and IPv6 with port 9090, and IWSVA can automatically redirect the authentication dialog box to IWSVA's IPv4 or IPv6 address to a client based on the client's IP address version.

- When the client uses an IPv4 address, IWSVA should send the redirect request with IWSVA's IPv4 address.
  - When the client uses an IPv6 address, IWSVA should send the redirect request with IWSVA's IPv6 address.
12. To verify the information has been entered correctly and IWSVA can communicate with the LDAP servers that you configured, click **Test LDAP Connection** on the **User Identification** page.

A message appears, indicating that you have successfully contacted the LDAP server.

13. Click **Save**.

---

**Note:** After the LDAP server has successfully been added, a new button appears that reads “Sync with LDAP servers.” Click this button to do a manual synchronization with your user group information.

---

## Cross Domain Active Directory Object Queries

Trend Micro recommends using the Global Catalog port (3268) as the IWSVA LDAP communication port when using Microsoft Active Directory. Using port 3268 enables cross domain group nesting object queries. This applies when an object's attribute on one domain refers to another object residing on a different domain (for example, cross-domain user or group membership that resides on different domains in a forest).

For retrieving cross-domain group object attribute(s), you must create groups with the “Universal” Group Scope to ensure that cross-domain group memberships within an Active Directory forest are included in the Global Catalog. Using the Universal Group Scope to create groups also allows cross-domain queries. Avoid creating or using Global Group policies when the Global Catalog has been enabled.

---

**Note:** To configure IWSVA to listen on port 3268, the Microsoft Active Directory server that IWSVA uses should have the Global Catalog enabled.

Since the member attribute is not replicated to the Global Catalog for all group types, and because the *memberOf* attribute derives its value by referencing the member attribute (called back links and forward links, respectively), search results for members of groups, and groups in which a member belongs, can vary. Search results depend on whether you search the Global Catalog (port 3268) or the domain (port 389), the kind of groups that the user belongs to (global groups or domain local groups), and whether the user belongs to universal groups outside the local domain.

---

For more information, search for the article “How the Global Catalog Works” at <http://www.microsoft.com>.

## Configuring the Scope of a Policy

Whether configuring HTTPS decryption, HTTP virus scanning, Applets and ActiveX security, URL filtering, Application Control, or access quota policies, the first step is the same—to configure the policy’s scope by identifying the client users to which the policy applies. The following three procedures describe how to select the accounts using the IP address and the User/group name authentication user identification methods.

---

**Note:** Selecting accounts by Host Name is not available for Application Control.

---

Those procedures are:

- [Configuring Policies Using IP Addresses on page 7-18](#)
- [Configuring Policies Using LDAP on page 7-19](#)

---

**Note:** Even if you configure IWSVA to use the Host name (modified HTTP headers) or User/group name authentication user identification method, you can always specify clients by entering an IP address or IP address range.

---

Before adding a policy and configuring its scope, set the user identification method. See [Configuring the User Identification Method starting on page 7-6](#) for more information.

## Configuring Policies Using IP Addresses

Configuring policies using the clients' IP addresses is the simplest identification method and is always available, regardless of the user identification method you have configured to use.

**To configure a policy's scope using the IP address user identification method:**

1. From the main menu, click **HTTP** and choose the type of policy to create (**HTTPS Decryption policies, Advanced Threat Protection Policies, HTTP Inspection Policies, Data Loss Prevention Policies, Applets and ActiveX Policies, URL Filtering Policies, or Access Quota Policies**).

---

**Note:** Access Application Control policies from the **Application Control > Policies** menu.

---

2. In the screen that corresponds to the type of policy selected, click **Add**.
3. Type a descriptive **new policy name**.  
Policy names that include references to the users or groups to which they apply (for example, "Virus Policy for Engineers" or "URL Filtering Policy for Researchers") are easily recognizable.
4. Select the users to which this policy applies by typing the upper and lower bounds of a contiguous range of IP addresses in the **From** and **To** fields. Alternatively, type a single **IP address**. Click the corresponding **Add** button to add the addresses to the policy.

5. When you have named your new policy and defined the IP address(es) to which it applies, click **Next** to proceed with the other policy settings.

## Configuring Policies Using LDAP

Before configuring a policy using users or groups from your LDAP server, set the user identification method and enter the details of your LDAP server. For more information, see [Configuring LDAP Settings starting on page 7-13](#).

### To configure a policy's scope using users and groups from an LDAP server:

1. From the main menu, click **HTTP** and then choose the type of policy to create (**HTTPS Decryption policies, Advanced Threat Protection Policies, HTTP Inspection Policies, Data Loss Prevention Policies, Applets and ActiveX Policies, URL Filtering Policies, or Access Quota Policies**).

---

**Note:** Application Control policies are configured at **Application Control > Policies**.

---

2. In the screen that corresponds to the type of policy that you selected, click **Add**.
3. Type a descriptive **new policy name**.
4. To query your LDAP directory for users or groups to add to your policy:
  - a. Check either **User** or **Group**.
  - b. Type the first part of the user or group name in the **Name** field and click **Search**.
  - c. When the list box displays users or groups that match your search criteria, highlight the user or group to add to the policy and click **Add**.
5. Repeat adding users or groups until your policy's scope is complete.
6. When you have named your new policy and defined the account(s) to which it applies, click **Next** and proceed with configuring the rest of the policy.
7. Configure multiple domains when the user's credentials exist on a different directory server than the one configured.

## Login Accounts

Up to 128 users can access IWSVA using assigned access rights. When in the application, users can make configuration changes that are recorded in the audit log (see [Audit Log on page 14-3](#)).

If you have a team of security administrators who are responsible for different functions and who might also have help desk privileges, then assigning them access rights can be beneficial to your organization. To manage IWSVA, these users can have different logon credentials with different privileges.

Access rights can also give you the ability to audit what is being changed in IWSVA. If you have the need to comply with certain government agency standards, then this function can be critical.

## Adding a Login Account

### To add a login account:

1. From the main menu, click **Administration > Management Console > Account Administration**.
2. In the Account Administration screen, click **Add**.
3. In the **Login Accounts** page, complete the necessary information:
  - **Username**—The name of the user assigned to the login account.
  - **Password**—Should be a mixture of alphanumeric characters between 4 and 32 characters long. Avoid dictionary words, names, and dates.
  - **Description**—The field that briefly describes the login account.
  - **Access Rights**—See [About Access Rights starting on page 7-21](#).
4. Click **Save**.

The new login account appears in the **Account Administration** screen.

## About Access Rights

There are three levels of access:

- **Administrator**—Users have complete and unrestricted access to the system. They can read and modify any settings accessible through the console, including creating, deleting, and modifying user accounts. Administrator can use this account and password to log into the CLI. This is the default access for new users.
- **Auditor**—Users cannot make any configuration changes; they can view configurations, logs, and reports. They can also change their passwords.
- **Reports only**—Users can only view the Dashboard and scheduled reports. They can generate logs and real-time report queries and change their own password.

---

**Note:** Accounts that have administrator privileges can log in to the terminal console through SSH.

---

## Changing a Login Account

**To change a login account:**

1. From the main menu, click **Administration > Management Console > Account Administration**.
2. Click on the desired username.
3. In the Login Accounts screen, change the necessary information:
  - **Username**—The name of the user assigned to the login account.
  - **Password**—Should be a mixture of alphanumeric characters between 4 and 32 characters long. Avoid dictionary words, names, and dates.
  - **Description**—The field that briefly describes the login account.
  - **Access Rights**—See [About Access Rights on page 7-21](#).
4. Click **Save**.

The changed login account appears in the **Login Accounts** screen.

---

**Note:** If an administrator account logs into the terminal console through SSH, and does not close the session, the administrator cannot modify the account directly to “Auditor” or “Reports only.” A warning message will appear.

---





# Chapter 8

## Configuring HTTP Scanning

This chapter describes how to configure HTTPS decryption, HTTP virus scanning, Advanced Threat Protection, and applets and ActiveX security policies in InterScan Web Security Virtual Appliance (IWSVA). Topics in this chapter include:

- [Enabling Advanced Threat Protection and Applets and ActiveX Security on page 8-2](#)
- [Advanced Threat Protection Performance Considerations on page 8-2](#)
- [HTTP Inspection Overview on page 8-3](#)
- [Data Loss Prevention on page 8-25](#)
- [HTTPS Security on page 8-28](#)
- [Creating and Modifying Advanced Threat Protection Policies on page 8-40](#)
- [X-Forwarded-For HTTP Headers on page 8-65](#)
- [Java Applet and ActiveX Security on page 8-75](#)
- [Applet and ActiveX Settings on page 8-86](#)
- [Managing Digital Certificates on page 8-91](#)

## Enabling Advanced Threat Protection and Applets and ActiveX Security

You can enable or disable HTTP scanning from the HTTP Scan Policies page of the IWSVA Advanced Threat Protection page.

---

**Note:** In addition to enabling HTTP scanning and Applet/ActiveX security, ensure that HTTP traffic is turned on, otherwise clients cannot access the Internet. (See [Enabling the HTTP/HTTPS Traffic Flow starting on page 6-2](#).)

---

### To enable HTTP scanning and Applets and ActiveX Security:

1. Go to **HTTP > Advanced Threat Protection > Policies**.
2. At the top of the page, check **Enable virus scanning** and **Enable Web reputation**, then click **Save**.
3. Go to **HTTP > Applets and ActiveX > Policies**.
4. At the top of the page, check **Enable Applet/ActiveX security**, then click **Save**.

## Advanced Threat Protection Performance Considerations

There are trade-offs between performance and security while scanning HTTP traffic for malicious content. When users click a link on a Web site, they expect a quick response. This response, however, might take longer as gateway antivirus software performs virus scanning. Some of the requested files might be large, and determining whether the file is safe requires downloading the entire file before it is relayed to the user. Content might also consist of many small files. In this case, the user's wait is the result of the cumulative time needed to scan the files.

One way to improve the user's experience is to skip scanning large files or files that are not likely to harbor viruses. For example, you can skip all files with an extension of `.gif`, or all files with a MIME type.

When configured to skip scanning a file because of its MIME content-type, IWSVA attempts to determine the file's true-file type (if you have enabled this feature) and match it to the claimed MIME type before skipping it. If the file's true-file type maps to a different MIME type than indicated in the Content-type header attached to the

transaction, the file is scanned. Unfortunately, there is not always a clear mapping between file types and MIME types. If you disable the true file type option, IWSVA does not map the true-file type to a MIME type, it is skipped according to the Content-type header as configured.

You can exclude files from scanning based on the file extension. Trend Micro recommends that you minimize the list of MIME content-types to skip. In general, relying on the scan engine to determine whether a file should be scanned is safer than trying to pick out which file types you want to skip yourself. First, the content-type HTTP header might not accurately represent the true type of the content to download. Second, some types that you might think are safe to skip (for example, text) might not really be safe (because scripts are text, and might possibly be malicious). One more area where you might want to use MIME content-type skipping is where you are consciously making a trade-off in safety versus performance. For example, a lot of Web traffic is text, and the IWSVA scan engine scans all that traffic because the content might contain scripts, which are potentially malicious. But if you are confident that you are browsing an environment that cannot be exploited by Web scripts, you might choose to add text/\* to your MIME content-type skip list so IWSVA does not scan Web pages.

Malicious code within a small file can quickly spread throughout a network. Malicious code that requires a large file for transport propagates more slowly, because the file containing malicious code takes longer to transmit. Therefore, it is important to screen small files efficiently and completely.

---

**Note:** System performance may be adversely affected if the main policy for ActiveX scanning directs all PE (windows executable) files to be scanned (not just COM objects, of which ActiveX controls are a subtype), or if all unsigned PE files are to be blocked. The performance impact occurs because the Javascan daemon—which enforces policy for these files—as well as Java Applets) is invoked more often.

---

## HTTP Inspection Overview

The HTTP Inspection feature in IWSVA provides policy control based on HTTP methods, URLs, and HTTP headers.

Web behavior has become more complicated. IT managers face many challenges, like enforcing browser type policies, blocking large file transfers to save bandwidth, blocking Web file uploads and blocking Web Distributed Authoring and Versioning (WebDAV) traffic. These actions are used to protect company data from loss, block video uploads, filter on keywords in headers and take action, and prevent message posting on social networking service (SNS) sites.

HTTP Inspection allows admins to identify behavior and filter web traffic according to HTTP methods, URLs, and headers. It also allows admins to create filters or use default filters to identify web traffic. After the traffic is identified, IWSVA can control it according to policy settings that allow admins to determine the appropriate actions for specific traffic.

---

**Note:** HTTP Inspection filters cannot inspect the data payload of the HTTP packets. For example, it cannot look for pattern matching inside the text or file of a webmail or social networking site post. It can only identify that a POST action is happening to a defined site or set of sites and prevent that POST.

---

Information about HTTP Inspection is shown in corresponding logs and reports. HTTP Inspection notifications are also available to inform end-users why their actions on the Web are being blocked.

## HTTP Inspection Policies

The HTTP Inspection Policy list at **HTTP > HTTP Inspection > Policies** shows all HTTP Inspection (IPv4 and/or IPv6) policies on the system—enabled as well as disabled. Click Add to create a new policy, or click a policy name to edit an existing one. See the following sections for details:

- [HTTP Inspection: Select Accounts on page 8-5](#)
- [HTTP Inspection: Specify Rules on page 8-6](#)
- [HTTP Inspection: Specify Exception Lists on page 8-8](#)

Editing an HTTP Inspection policy requires clicking on the policy name, then clicking the **Rule** tab.

## HTTP Inspection: Select Accounts

Filters are required to add an HTTP Inspection policy. Several default filters are provided, but to create a policy using a custom filter, you must create the filters first at **HTTP > HTTP Inspection > Filters**. Acceptable accounts include a single IP address, an IP range, or an IP mask for both IPv4 and/or IPv6 accounts.

### To select accounts for an HTTP Inspection policy:

1. Go to **HTTP > HTTP Inspection > Policies**.
2. Click **Add**.
3. Enter or determine the following information:
  - **Enable policy**—Enable or disable the individual policy.

---

**Note:** If you have HTTP Inspection policies disabled at the global level (through **HTTP > HTTP Inspection > Policies**), the enabled status of an individual policy will be ignored.

---

- **Create new policy**—Type a brief but descriptive name for the policy rule. Names must be unique, and will appear in the list of policies that appears when you click **HTTP > HTTP Inspection > Policies**.
- **Select the users to which the policy applies**—The options on this page depend upon the user identification method that you are using—either IP address, Hostname (modified HTTP headers), or User/group name authentication. For more information about configuring the user identification method and defining the scope of a policy, see [Configuring the User Identification Method on page 7-6](#).

---

**Note:** Before choosing a Hostname, you need to prepare all clients on the LAN by running the following program on each client:

```
/usr/iwss/bin/register_user_agent_header.exe
```

This can be done by adding it to your Windows domain login script (or by creating one only for this purpose.)

---

4. Click **Next** to specify the rules and exception, if any, for the new policy.

## HTTP Inspection: Specify Rules

The Rules screen allows you to select the Inspection Filters for HTTP traffic. Adding an HTTP Inspection policy is a three-step procedure. First, create an account, then assign HTTP Inspection filtering rules to the new account, and then specify any exceptions.

### To specify the rules in your HTTP Inspection policy:

1. Complete the steps in [To select accounts for an HTTP Inspection policy: on page 8-5](#).

**HTTP Inspection Policies: Add Policy**

HTTP Inspection Policies: > (New Policy)  Enable policy

1. Select Accounts  
2. Specify Rules  
3. Specify Exception Lists

Create new policy: \*   
 Copy from existing policy: \* Select one

IP range:  
From:   
To:

IP/Hostname:

IP Subset:  
Address:   
Prefix Length: [?]

| Type | Identification |
|------|----------------|
|      |                |

Note: To select accounts by Host name or User/group name, change the User Identification method at **Administration > IWSVA Configuration > User Identification**.

**FIGURE 8-1. Configuring HTTP Inspection policy blocking all content posting to defined social networking sites**

2. Enter information or determine the following:
  - **Enable policy**—Enables or disables the individual policy; the global HTTP Inspection setting overrides the specifications of an individual policy.

- **Inspection Filter**—Choose the Inspection Filter to designate the type of traffic to which the policy will apply. The number of filters available is equal to the default filters plus any custom filters that have been created. [Table 8-1](#) describes the default filters.

---

**Note:** You can create custom filters at **HTTP > HTTP Inspection > Filters > Add**.

---

- The following describes the available filtering actions:
  - **Allow (scan)**—Connection to the target server is allowed and users can access the Web site, but the content is scanned for malware.
  - **Allow (no scan)**—Connection to the target server is allowed and users can access the Web site, but the content is not scanned for malware.
  - **Block**—Connection to the target server is not established and users are not allowed to access the Web site. A log entry is also created for this event.
  - **Monitor**—Connection to the target server is allowed and users can access the Web site. A log entry is also created for this event.

---

**Note:** Note: For the next section, restricted days and hours are defined at **Administration > IWSVA Configuration > Scheduled Times**.

---

- **Action During/Scheduled Times**—Check the check box of the inspection filter name (or names) beside the work time column. (To select all the filters, click the check box at the top of the column.) Select the Action to be applied from the drop-down list. (Default time is **Always**). Click **Apply** to apply the filtering action to the traffic found by the selected inspection filters.
  - **Notes**—Use to create policy notes, for example, to summarize the intent or justification for the policy. It can serve as a simple reminder or as a communication to others who could later administer HTTP Inspection.
3. Click **Next** to continue.

## HTTP Inspection: Specify Exception Lists

There may be URLs or Web sites that you want to exempt from HTTP Inspection filtering (for example, the corporate intranet, business partner sites, and research tool sites). URLs in the exception list will not be blocked or monitored.

You can create exception lists in the **HTTP > Configuration > Approved Lists** page.

### To specify exception to the HTTP Inspection policy:

1. Configure the accounts and rules.
2. On the HTTP Inspection Policies: Add Policy Exceptions page, select the name from the drop-down list of the Approved URL List to be exempted from a HTTP Inspection rule.

---

**Note:** Approved lists are configured at **HTTP > Configuration > Approved Lists**.

---

3. Click **Save**. Your new policy will now appear in the list of policies at **HTTP > HTTP Inspection > Policies**.

## HTTP Inspection Filters

The HTTP Inspection filters provide a general way to identify Web traffic. It allows for the creation of filtering conditionals using the following components:

- URL Host
- URL Path
- URL Query
- HTTP Method
- HTTP Header

## Default HTTP Inspection Filters

Default filters for HTTP Inspection provide filtering for common scenarios, such as blocking social networking services (SNS) uploads or regulating Web access through the use of certain types of browsers.



The default filters provided:

- **Browser-type filter**—Identifies requests sent from the FireFox browser according to the user-agent header
- **Large data download filter**—Identifies large file downloads according to the content-length header
- **Large data upload filter**—Identifies large file uploads according to the content-length header
- **Query keyword filter**—Identifies sensitive keyword querying using search engines like Google, Baidu, etc.
- **SNS site post filter**—Identifies post request (including message posts and video file uploads) for the three popular sites: Facebook, YouTube, and Twitter. Additional sites can be added by the administrator as necessary.
- **WebDAV traffic filter**—Identifies WebDAV special request methods PROPFIND, PROPMATCH, MKCOL, COPY, and MOVE
- **Web file upload filter**—Identifies web file uploads (like BBS or Webmail file uploads) according to the content-type header

- **SNS site post filter**—Identifies post request (including message posts and video file uploads) for the top three sites: Facebook, YouTube, and Twitter. Additional sites can be added by the administrator as needed.

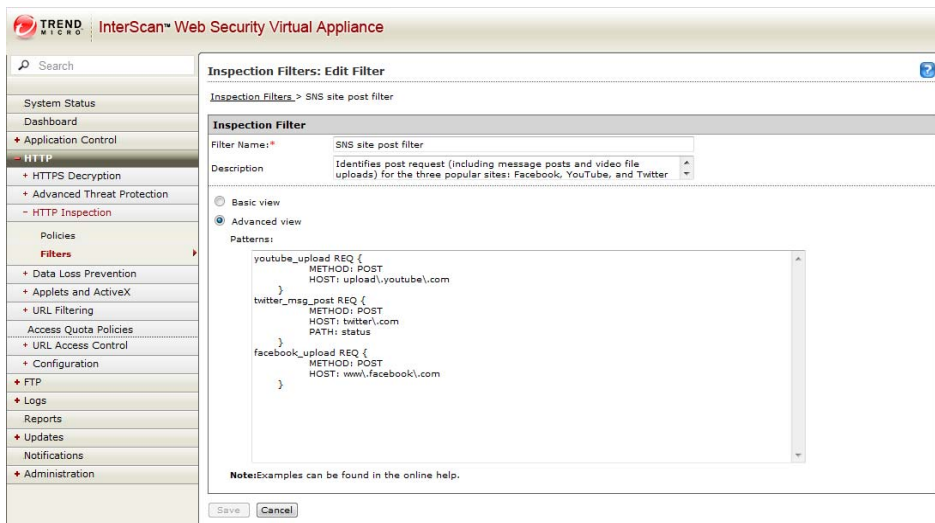

**FIGURE 8-2.** HTTP Inspection filter configuration for preventing POST actions to defined social networking sites

See [Table 8-1](#) for the default filter settings. Admins can make minor adjustments to the default or pre-defined filters to obtain the control capabilities needed.

- **Add**—Opens the Add Filter wizard that will take you through the steps of defining a new filter.
- **Delete**—Allows you to delete a filters.
- **Export**—Allows you to export existing filters.

- **Import**—Allows you to import custom filters created elsewhere or by technical support

**TABLE 8-1. Matrix of Default HTTP Inspection Filters**

| DEFAULT FILTER NAME  | FILTERING TYPE | REQUEST METHOD | URL HOST | URL PATH | URL QUERY  | HEADER (NAME/ OPERATOR/ VALUE)   |
|----------------------|----------------|----------------|----------|----------|------------|----------------------------------|
| BROWSER TYPE         | REQ            | None           | None     | None     | None       | User-Agent/ Contains/ FireFox    |
| LARGE DATA DOWN-LOAD | RESP           | N/A            | None     | None     | None       | Content-length/ $\geq$ / 1048576 |
| LARGE DATA UPLOAD    | REQ            | None           | None     | None     | None       | Content-length/ $\geq$ / 1048576 |
| QUERY KEY-WORD       | REQ            | None           | None     |          | <key-word> | None/None/ None                  |

TABLE 8-1. Matrix of Default HTTP Inspection Filters (Continued)

| DEFAULT FILTER NAME    | FILTERING TYPE | REQUEST METHOD | URL HOST                                                                                                                                                                                                                                                                                                                                       | URL PATH | URL QUERY | HEADER (NAME/ OPERATOR/ VALUE)                     |
|------------------------|----------------|----------------|------------------------------------------------------------------------------------------------------------------------------------------------------------------------------------------------------------------------------------------------------------------------------------------------------------------------------------------------|----------|-----------|----------------------------------------------------|
| <b>SNS SITE POST</b>   | REQ            | POST           | (Added in Advanced View)<br><br><b>youtube_upload</b><br>REQ {<br>METHOD: POST<br>HOST:<br>upload\.you-<br>tube\.com }<br><br><b>twitter_msg_po</b><br><b>st</b> REQ {<br>METHOD: POST<br>HOST: twit-<br>ter\.com<br>PATH: status<br>}<br><br><b>facebook_uploa</b><br><b>d</b> REQ {<br>METHOD: POST<br>HOST:<br>upload\.face-<br>book\.com } | None     | None      | None/<br>None/<br>None                             |
| <b>WEB FILE UPLOAD</b> | REQ            | POST           | None                                                                                                                                                                                                                                                                                                                                           | None     | None      | Content-Type/<br>Contains/<br>multi-part/form-data |

TABLE 8-1. Matrix of Default HTTP Inspection Filters (Continued)

| DEFAULT FILTER NAME | FILTERING TYPE | REQUEST METHOD                           | URL HOST | URL PATH | URL QUERY | HEADER (NAME/ OPERATOR/ VALUE) |
|---------------------|----------------|------------------------------------------|----------|----------|-----------|--------------------------------|
| WEbDAV              | REQ            | PROP-FIND<br>PROP-MATCH<br>MKCOL<br>COPY | None     | None     | None      | None/<br>None/<br>None         |

## Add an HTTP Inspection Filter

There are two ways to add HTTP Inspection filters:

- **Basic view**—Common component of a filter are provided, offering options for the filtering type (HTTP request or response), URL host, URL path, URL query, and request or response header.
- **Advanced view**—Allows you to enter patterns

---

**Note:** New filters can also be added by clicking on the name of an existing filter, then modifying it as needed and saving it under a different name.

---

### Adding a Filter in Basic View

The filter configured in the Basic View defines the following:

- **Filter name and description**—Name and description assigned to the new filter by the user.
- **HTTP request or response**—Denotes the traffic direction
- **Filter scope**—Includes the HTTP method (HTTP request only), path, query, and/or header



**TABLE 8-2. Components shown in the Packet Capture**

| NUMBER | COMPONENT       |
|--------|-----------------|
| 1      | Request method  |
| 2      | URL host        |
| 3      | URL path        |
| 4      | URL query       |
| 5      | Request header  |
| 6      | Response header |

**To add a new HTTP Inspection filter in the basic view:**

1. Go to **HTTP > HTTP Inspection > Filters**.
2. Click **Add**.
3. Enter a filter name and description.
4. Select the **Basic view** radio button. See *Figure 8-2*.
5. Select the filtering type, either HTTP Request or HTTP Response, depending on the direction for which you want to create a filter:
  - **HTTP Request**—Creates a filter used when clients send a request to the Web server to retrieve an HTML page. Request filters include the following scope: request method, URL host, URL path, URL query, and HTTP header.
  - **HTTP Response**—Creates a filter used when the Web server returns a response message to the client. Response filters include the following scope: URL host\*, URL path\*, URL query\*, and HTTP response header.

---

**Note:** Information for the items above with an asterisk (\*) are obtained from the HTTP request. The response does not contain this information.

---

6. Enter values to define the filter by configuring one or more of the following options:
  - (HTTP Request Filtering type only) Check the **Request Method** check box. To limit the scope of the filter, provide the HTTP request method. The value can be those show in [Table 8-3](#) or any other extension method value.

**TABLE 8-3. Method Values for HTTP Request Filters**

| METHOD  | DESCRIPTION                                                                                                                                                                                                                                   |
|---------|-----------------------------------------------------------------------------------------------------------------------------------------------------------------------------------------------------------------------------------------------|
| DELETE  | Deletes the specified resource                                                                                                                                                                                                                |
| GET     | Requests a representation of the specified resource.                                                                                                                                                                                          |
| HEAD    | Asks for the response identical to the one that would correspond to a GET request, but without the response body. This is useful for retrieving meta-information written in response headers, without having to transport the entire content. |
| OPTIONS | Returns the HTTP methods that the server supports for specified URL. This can be used to check the functionality of a web server by requesting '*' instead of a specific resource.                                                            |
| POST    | Submits data to be processed (e.g., from an HTML form) to the identified resource. The data is included in the body of the request. This may result in the creation of a new resource or the updates of existing resources or both.           |
| PUT     | Uploads a representation of the specified resource.                                                                                                                                                                                           |
| TRACE   | Echoes back the received request, so that a client can see what (if any) changes or additions have been made by intermediate servers                                                                                                          |



---

**Note:** Users can define multiple keywords with an OR relation, separated by the ‘|’ character or on a new line for the URL Query, URL Path, Header, or HTTP Method options.

---

- Check the **URL Host** check box. Type the host name or IPv4/IPv6 address (including port number, if any) as part of the URL.
- Check the **URL Path** check box. Type the path part of the URL (if any) after, but not including, the final “/” of the host part, and up to, but not including, the “?” of the query, if any.
- Check the **URL Query** check box. Type the query part of the URL (if any), after, but not including, the “?” and up to the end of the URL string in the field below the translation wizard.
  - If you need to translate a UTF-8 string, check the **Need a translator** check box.

---

**Note:** Keyword queries are only supported in UTF-8 encoding. Use URL-encoded hex code to match multiple-byte characters with other character sets.

---

- Type the UTF-8 string to translate.
- Select the appropriate character set:
  - Chinese Simplified (GB2312)
  - Chinese Traditional (Big5)
  - Japanese (EUC)
  - Japanese (Shift-JIS)
- Click **Translate** and the translated value appears in the Translated string field.
- Check the **Header** check box. To select the Name and Value heading to be used, click the “+” sign in the last column. This supports both string-value matching and integer-value comparison:
  - **Contains | Not Contain** means the value contains or does not contain the input keywords using a simple string comparison.

- Add multiple keywords with an OR relation, separated by the “|” character.
- =, ≠, ≥, ≤ —Means integer-value comparison
- **Exist/Not exist**—Means the header includes or does not include the defined header
- The web traffic is matched by one filter only if all the defined scopes are matched, which means there is an AND relation in METHOD, HOST, PATH, QUERY, and multiple HEADERS.
- Type the values to be used and select the appropriate operation (Contains, Not Contain, equals, does not equal, greater than or equal to, or less than or equal to) from the drop-down list.

7. Click **Save**.

Your new filter name now appears in the list of filters at the HTTP > HTTP Inspection > Filters.

### Adding a Filter in the Advanced View

You can edit filter definitions in text mode with defined syntax. (HTTP BODY is not supported.) Regular expressions are supported. All regular expressions are applied (see <http://www.pcre.org/pcre.txt>). See *Table 8-4* for the active Perl-Compatible Regular Expressions (PCRE) flags.

**TABLE 8-4. Active PCRE Flags for Use in Configuring Patterns**

| REGULAR EXPRESSION  | DESCRIPTION                                                                                                               |
|---------------------|---------------------------------------------------------------------------------------------------------------------------|
| PCRE_DOTALL         | The '.' (period) character matches any byte, including the EOL characters CR ('\r') and LF ('\n').                        |
| PCRE_DOLLAR_ENDONLY | The '\$' (dollar sign) character matches only the absolute “end of source” (the end of the data), and does not match EOL. |

**TABLE 8-4. Active PCRE Flags for Use in Configuring Patterns (Continued)**

| REGULAR EXPRESSION | DESCRIPTION                                                                                                                                                                                                                                                                                                                                                                                                                                                                                                                                                |
|--------------------|------------------------------------------------------------------------------------------------------------------------------------------------------------------------------------------------------------------------------------------------------------------------------------------------------------------------------------------------------------------------------------------------------------------------------------------------------------------------------------------------------------------------------------------------------------|
| PCRE_EXTENDED      | <p>The main effect of this is that the following characters (as literals) are ignored in regular expression definitions:</p> <p>' ' (space), tab, carriage return, line feed, form feed, '#'</p> <p>However, the escaped forms of these characters are obeyed:</p> <p>'\ ', '\t', '\r', '\n', '\f', '\#'.</p> <p>The main reason this is done is to allow regular expression definitions to be formatted in a more readable manner (with white space emphasizing structure and branches), and to allow them to be easily split across line boundaries.</p> |

**Note:** Note: PCRE\_DOTALL and PCRE\_EXTENDED may be turned off by including '(?-s)' and '(?-x)', respectively, in an expression.

Other rules include:

- The PCRE runtime flag PCRE\_UTF8 ("UTF-8 mode") is never used. This means that the '?' character will always match only one byte.
- In signature definitions, EOL may be escaped by using '\' (backslash) at the end of the line (in the Unix shell manner). Note that this is not part of the PCRE regular expression language and, to be safe, the line continuation backslash should be preceded by at least one space. When assembling a multi-line regular expression for use, the line-end backslashes are stripped, and then all leading and trailing white space is stripped from each line before the lines are concatenated.

**To add a new HTTP Inspection filter in the advanced view:**

1. Go to **HTTP > HTTP Inspection > Filters**.
2. Click **Add**.
3. Enter a filter name and description.

4. Select the **Advanced view** radio button. See *Figure 8-4*.

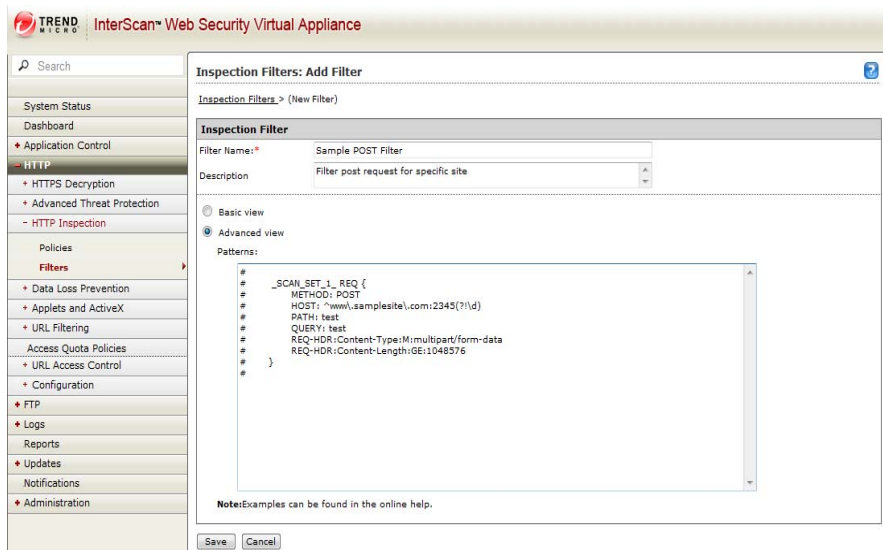

**FIGURE 8-4. Sample Request mode POST filter in Advanced view**

5. Enter a pattern in the **Patterns** field. Use the following syntax:

**Note:** The [Filter Type] must be replaced with REQ (for request mode) or RESP (for response mode.)

```
[ScanSetName] [Filter Type] {
[TAG]:RegularEx
[HDR-TAG]:[HDR-NAME]:[HDR-OP]:RegularEx
[TAG]
METHOD, HOST, PATH, QUERY
[HDR-TAG]
REQ-HDR, RESP-HDR
[HEADER_OP]:
```

-----

EQ : =  
NE : !=  
GE : >=  
LE : <=  
M : Contain  
NM : Not Contain  
X : Exist  
NX : Not exist

- a. Here is a sample pattern for Request mode:

```
#
_SCAN_SET_1_ REQ {
METHOD: POST
HOST: ^www\.samplesite\.com:2345(?:\d)
PATH: test
QUERY: test
REQ-HDR:Content-Type:M:multipart/form-data
REQ-HDR:Content-Length:GE:1048576
}
#
```

- b. Here is a sample pattern for the Response mode:

```
#
_SCAN_SET_2_ RESP {
HOST: ^www\.samplesite\.com:2345(?:\d)
PATH: test
QUERY: test
RESP-HDR:Content-Type:M:multipart/form-data
RESP-HDR:Content-Length:GE:1048576
}
#
```

---

**Note:** Other considerations:

1. For integer value comparisons, IWSVA converts the string value part. The string may include a '0x' prefix, and the number will be read in base 16; otherwise, it is interpreted as 10 (decimal) unless the next character is '0', in which case it is interpreted as 8 (octal).
  2. If the first non-space character is not a sign or a digital number, then it is not a number.
  3. Do not include RESP-HDR in a request header check rule. You cannot add headers which only appear in response headers to a request type filter.
  4. Do not include METHOD and REQ-HDR in a response header check rule. You cannot add headers which only appear in request headers to a response type filter. When using the advanced view to create new filters, do not use METHOD in the response type filter.
  5. IWSVA does not verify if filters comply with the HTTP protocol. Filters written incorrectly do not work.
- 

6. Click **Save**.

## Editing an HTTP Inspection Filter

You can modify existing filters or use them as a basis for creating new filters.

If you are editing an HTTP Inspection filter, you may edit:

- Filter name
- Filter description
- Filter methods (Basic view)
- Filter patterns (Advanced view)

You can modify a filter in the basic or advanced view.

### To modify a filter:

1. Got to **HTTP > HTTP Inspection > Filters**.
2. Click on the name of the filter to be modified.
3. Change parameters as shown in:

- [To add a new HTTP Inspection filter in the basic view: on page 8-15](#)
  - [To add a new HTTP Inspection filter in the advanced view: on page 8-19](#)
4. Click **Save**.

## Importing an HTTP Inspection Filter

Two types of HTTP Inspection filters can be imported:

- New filters created by the users in a text file outside of IWSVA
- Custom filters created by Trend Micro support

Filter files are XML files. Imported filter files must conform to a defined standard shown in [To create a filter to import: on page 8-23](#).

### To create a filter to import:

1. Imported filter XML files can be created in several ways:
  - Exported from IWSVA
  - Created as a new file
2. If you are creating a new file, use the following sample format:

```
<?xml version="1.0" encoding="UTF-8"?>
<SDF>
 <Filter Mode="Basic" Name="Browser type filter" ID="1">
 <Note>Identifies requests sent from the Firefox browser
according to the
user-agent header</Note>
 <Basic Type="REQ">
 <Headers Enable="true">
 <Header Value="Firefox" Op="M"
Name="User-Agent" />
 </Headers>
 </Basic>
 </Filter>
 <Filter Mode="Basic" Name="Large data upload filter" ID="3">
```

```
<Note>Identifies large file uploads according to the
content-length header</Note>
<Basic Type="REQ">
 <Headers Enable="true">
 <Header Value="1048576" Op="GE"
Name="Content-Length"/>
 </Headers>
</Basic>
</Filter>
<Filter Mode="Basic" Name="Query keyword filter" ID="4">
 <Note>Identifies query keyword for search engine
website, etc.</Note>
 <Basic Type="REQ">
 <Query Enable="true">
 <Value><![CDATA[[put query keywords
here]]]></Value>
 </Query>
 </Basic>
</Filter>
</SDF>
```

**To import a filter:**

1. Go to **HTTP > HTTP Inspection > Filters**.
2. Click the **Import** link.
3. Click **Browse** and specify the path and filter to be imported.
4. Click **Import**.
5. View the name of the imported filters in the list of filter names.



## Exporting an HTTP Inspection Filter

Existing filters can be exported for several reasons:

- Filters can be used elsewhere
- Custom filters created by Trend Micro support services that can be exported, sent to a customer, and then imported by an IWSVA administrator.

---

**Note:** Do not manually edit exported filter files. Changes might prevent them from importing successfully.

---

### To export a filter:

1. Go to **HTTP > HTTP Inspection > Filters**.
2. Check the box of the name or names of files to be exported.
3. Click the **Export** link. (An error message appears if no filter name was selected.)
4. In the **Save As** dialog box, select the location for the file to be save. Use the default file name or change it.
5. Click **Save**.

## Data Loss Prevention

Data Loss Prevention (DLP) has been added to IWSVA to provide users the ability to:

- scan outbound traffic for content that includes sensitive corporate data.
- create and modify policies using predefined templates to better meet regulatory privacy requirements in various countries by filtering for personally identifiable information.
- create and modify custom policies using keywords and regular expressions to help filter on intellectual property - as defined by the customer.
- provide reports on which DLP policies have been violated by which users.
- provide auditing functions for administrators to measure the effectiveness (catch rate and false positive rate) of the DLP policies in the product.

---

**Tip:** As a best practice, it is strongly recommended to first create a policy that imposes the strictest rules for as many targets (users or endpoints) as possible (such as All

Endpoints or All users), and then create policies for a few endpoints or users as the exception from “All Endpoints” or “All users.”

---

## Policies

Use the DLP Policies page to create these across-the-board company rules and criteria that your company's files should meet.

From the DLP Policies page, you can add, edit, delete, or save your company's Data Loss Prevention policy. You can also control whether or not the feature is enabled by clicking the **Enable DLP** checkbox. IWSVA includes the DLP Scan Default Policy that can be modified, but not deleted.

### To access the DLP Policies page:

1. Go to **HTTP > Data Loss Prevention > Policies**.  
The Data Loss Prevention Policies page appears.
2. Choose a policy to edit, delete, or if desired, add a new policy. The sections that follow describe the steps necessary.

### To modify an Existing DLP Policy:

1. Go to **HTTP > Data Loss Prevention > Policies** and click the name of the desired policy you would like to modify.  
The DLP Policies: Policy page appears.
2. Each policy template is categorized by particular regions or industries that you can choose to Allow, Block, or Monitor.
3. Click the Plus icon to the left of the rule template you would like to enforce.
4. Modify as desired by selecting the rule's checkbox and by using the pull-down, change to the desired behavior and click **Apply**.  
The Action icon will change to the requested status.

### To add a new DLP policy:

1. Go to **HTTP > Data Loss Prevention > Policies** and click **Add**.  
The Data Loss Prevention Policies: (New Policy) page appears.
2. Adding a new policy requires three steps; selecting the accounts, specifying the rules, and specifying the exception lists.

3. Enter the policy name and a general description of the policy.
4. Enter any useful account information by defining the targets to be protected or monitored. On this page, you can select targets from an IP range or a specific IP address.

---

**Note:** These account fields support IPv6 addresses. You can define one rule for any IPv6 host, and this policy rule is triggered when the client sends data violating the company's security policies through IWSVA.

---

5. Select to target a specific user or an entire group of users. Name the user or group and click **Search**.
6. Click **Next**.  
The Specify Rules page appears.
7. Similar to Editing an Existing Policy, use a defined DLP Template, or modify a policy template categorized by particular regions or industries where you can scan content by selecting target templates that enable you to Allow, Block, or Monitor particular rules.  
The default scan traffic is set for HTTP/HTTPS.
8. Click the Plus icon to the left of the rule template you would like to enforce.
9. Modify as desired by selecting the rule's checkbox and by using the pull-down, change to the desired behavior and click **Apply**.
10. The Action icon will change to the requested status.
11. Fill the remaining page elements.
12. Click **Next**.  
The Specify Exception Lists page appears.
13. Specify the settings for the Approved URL list, the approved file name list, and if you would like to limit the sizes of files, enter the size limitation and click the checkbox.
14. Click **Save**.

## Templates

The template page shows all the template defaults as well as any templates customized by the administrators. These templates are displayed by their associated industry or region and include descriptions of each. You can Add, Copy, Delete, Import, or Export templates through this page.

### To add a new compliance template:

1. Go to **HTTP > Data Loss Prevention > Templates** and click **Add**.  
The Add Compliance Template page appears.
2. Enter a name and description for the compliance template you are adding.
3. Define each digital asset as either an expression or a keyword.
4. Select predefined expressions or keyword items as “Digital Asset Definition” with a fixed number occurrence or combined with the logic expressions “And”/“Or” in a new Compliance template.
5. Additional digital assets can be added by clicking the plus symbol at the left of the page.
6. Click **Add** to create the new digital asset.
7. Click **Save** to complete.

## iDLP

IWSVA 6.0 includes a TCM 6.0 DLP widget in which company administrators can deploy DLP policies/templates to IWSVA from TCM 6.0. Administrators can use TCM 6.0 to manage organization-wide DLP policies for Trend products including IWSVA 6.0.

## HTTPS Security

HTTPS (Hypertext Transfer Protocol with Security) is a combination of HTTP with a network security protocol (such as SSL, Secured Sockets Layer). HTTPS connection is used for Web applications (such as online banking) that require secured connections to protect sensitive content. Since traditional security devices are unable to decrypt and inspect this content, virus/malware and other threats embedded in HTTPS traffic can pass unobstructed through your security defenses and on to your enterprise network.

IWSVA closes the HTTPS security loophole by decrypting and inspecting encrypted content. You can define policies to decrypt HTTPS traffic from selected Web categories. While decrypted, data is treated the same way as HTTP traffic to which URL filtering and scanning rules can be applied. In addition, decrypted data is completely secure since it is still in the IWSVA server's memory. Before leaving the IWSVA server, the data is encrypted for secure passage to the client's browser.

---

**Note:** In the reverse proxy mode, IWSVA tunnels HTTPS traffic. HTTPS decryption is not supported in the Reverse Proxy Mode.

---

IWSVA supports HTTPS decryption and scanning in the following modes:

- Transparent bridge
- WCCP
- Forward proxy

## Dangers of Unchecked HTTPS Content

The following lists some major concerns about HTTPS connections:

- Virus scanning and content filtering policies cannot be applied to encrypted data
- Digital certificates can be forged, expired or revoked since clients rarely check the certificate revocation list
- Legitimate certificates can be easily obtained by a malicious third-party, causing users to assume that the information they provide is secure
- Web browsers are vulnerable to certificate insertion attacks that allows a malicious intruder to gain access to a corporate intranet
- Users may not have the required knowledge to decide if a certificate is to be trusted
- Monitoring HTTPS traffic is difficult since the URL path and other information are concealed

## SSL Handshake Overview

To use the SSL protocol to establish an HTTPS connection, a Web server needs to install an SSL certificate. Certificates are supplied by a Certificate Authority (CA) and helps determine that a Web site is trustworthy, sensitive information (such as credit card numbers) is encrypted, and data transmitted cannot be tampered with and forged.

When a client initiates an SSL session by typing a URL that starts with https:// instead of http://, an SSL handshake is performed to verify identification (such as certificate exchange and validation) and process encryption methods required for the session. The IWSVA server acts as an intermediary between a client and a secure Web server to validate server certificates. The following describes a simplified SSL handshake process:

1. The client Web browser sends a connection request and its encryption data to the Web server. IWSVA forwards the request to the Web server.
2. The Web server returns its SSL information (including the server certificate). IWSVA checks the server certificate.
3. If the server certificate passes validation tests, the HTTPS connection is allowed between the Web server and the client. IWSVA applies HTTPS decryption policies to scan encrypted content.

If the Web server requests a client certificate, IWSVA either blocks or tunnels the encrypted traffic.

For more information on server certificate management, refer to [Managing Digital Certificates on page 8-91](#).

## HTTPS Decryption and Process Flow in IWSVA

After an HTTPS connection is allowed between the Web server and the client, IWSVA closes the HTTPS security loophole by decrypting and inspecting encrypted content. You can define policies to decrypt HTTPS traffic from selected Web categories. While decrypted, data is treated the same way as HTTP traffic to which URL filtering and scanning rules can be applied.

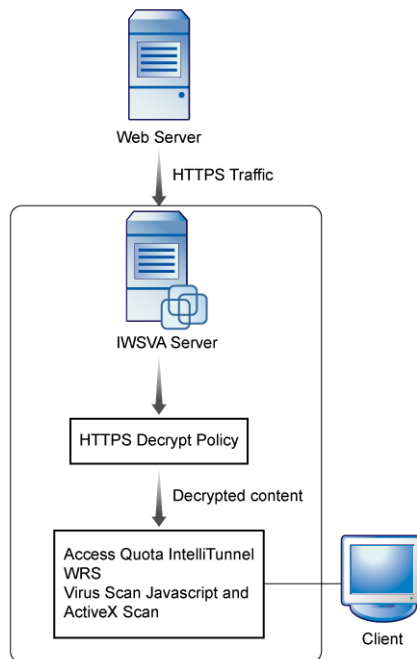

**FIGURE 8-5. Decrypted HTTPS traffic flow in IWSVA**

The HTTPS decryption feature offers the following benefits:

- Decryption at the gateway—IWSVA is able to decrypt HTTPS traffic and apply existing security policies.
- Data privacy is preserved—Decrypted data is completely secure since it is still in the IWSVA server’s memory. Before leaving the IWSVA server, the data is encrypted for secure passage to the client’s browser.

- Central certificate handling—IWSVA verifies certificates issued by remote servers and manage certificates to relieve clients of the critical tasks.

## Configuring HTTPS Decryption Policies

Before IWSVA can apply scanning and filtering policies on encrypted content, you must configure HTTPS decryption policies to decrypt the content. Similar to the way you configure URL filtering policies, you configure HTTPS encryption policies to decrypt content based on selected Web categories. For example, you can configure an HTTPS decryption policy to decrypt encrypted content from Web sites in the Business categories.

HTTPS decryption and URL filtering policies use the same Web category grouping and naming. You can also configure custom categories to meet the needs of your company or users.

---

**Note:** IWSVA only matches the first custom category regardless of whether zero or more than one custom category is selected.

In bridge mode, if a proxy server is located between IWSVA and the Web server and client browsers are configured to access the Internet through the proxy server, IWSVA tunnels or decrypts and scans HTTPS connections based on the policy settings.

---

## HTTPS Accelerator Card Support

For customers that have more than 20-25 percent of their total traffic as HTTPS, IWSVA has drivers that support HTTPS accelerator cards, which can be used for the demanding computational calculations needed for HTTPS and save the general purpose CPU cycles for other IWSVA functions, such as content inspection. The accelerator card is designed to off-load the CPU intensive operations of SSL key pair negotiation, decryption of the HTTPS stream for content inspection, and re-encryption of the content for secure delivery to the client workstation.



IWSVA supports several Silicom cards:

- PCI-E 61
- PCI-X 51
- PESC62

Using the accelerator card allows systems to off-load high-level SSL or IPsec protocol commands that reduce the host I/O traffic and system processor to increase the total system throughput. This also frees system processor resources for other functions, increasing overall system performance.

## Domain Tunneling

HTTPS Tunnels can be used to communicate between network locations with restricted connectivity – usually being locations behind NATs, firewalls, or proxy servers. Restricted connectivity is usually the result of blocked TCP/IP ports, blocked traffic initiated from outside the network, or from the blocking of most network protocols is how a network can be locked down to secure it against internal and external threats.

Similar to a global trusted list, domain tunneling allows administrators to maintain a list of trusted sites.

### To set up domain tunneling:

1. Go to **HTTPS > HTTPS Decryption > Tunneling**.
2. Enter the domain name match to be added.
3. Select to match by a string (exact name) or to match by an entire domain. (An asterisk will appear next to tunnels made through entire domains.)
4. If you have a previously created file with approved entries already included, click **Choose File**, select the file you want to add, then click **Import**.  
The Tunneled Domains you add will appear in the Tunneled Domains box.
5. Click **Save**.

## Tunneled Domains

Obsolete tunnels can be deleted by highlighting the tunnelled domain and clicking **Remove**, or clear the entire list by clicking **Remove all**. You can also save your list of tunnelled domains by clicking **Export** and saving the list to a secure location.

## Exceptions to the Tunneled Domains

Exceptions can be listed as well. All domains in the exception list will be decrypted.

## Failed HTTPS Accesses

Failed HTTPS access attempts can be tracked and recorded. Administrators can add a tunneled domain into a tunnel list for site surfing. Logs can be queried based on time, user name and domain.

In the Action column, a button is provided to add the domain name into the tunneling list. If the domain is already in the list, the column space will read “Tunneled.”

### To search for failed HTTPS Access attempts:

1. Go to **HTTPS > HTTPS Decryption > Tunneling - Failed HTTPS Accesses**.
2. Select the option to Enable Auto Tunneling for Fatal Failures if you would like to initiate auto-tunneling.
3. Choose the number of failed HTTPS accesses you would to review, 20, 50 or 100 entries.
4. To search for a specific user's attempted access, enter the user name in the **Search** box as well as the user's Domain.

For each entry, the following information is shown:

- Date
- User Name (user or IP)
- Domain Name
- Failure Reason
- Action

The Action column will reveal a button for you to add the domain name into your tunneling list. If the domain is already in the list, the Action will show “tunneled” instead.

## Creating a New HTTPS Decryption Policy

Creating a new HTTPS decryption policy is a three-step process:

- Select the accounts to which the policy applies

- Specify the Web site categories whose traffic you want to decrypt
- Select an exception list

**To create a new HTTPS decryption policy:**

1. Open the IWSVA Web console and click **HTTP > HTTPS Decryption > Policies** from the main menu.  
Click **Add**. The **HTTPS Decryption Policy: Add Policy** screen appears.
2. Type a descriptive policy name in the “Create new policy” box.  
Policy names that include references to the users or groups to which they apply, for example, “HTTPS decryption policy for Web Mail,” are easier to remember.
3. Select the users to which the policy applies.  
The options on this page depend upon the user identification method that you are using—either *IP address*, *Host name (modified HTTP headers)*, or *User/group name authentication (LDAP)*. For more information about configuring the user identification method and defining the scope of a policy, see [Configuring the User Identification Method starting on page 7-6](#).
4. Click **Next**.
5. On the **Specify Categories** screen, ensure that **Enable policy** is selected.
6. Select the URL categories to decrypt.  
To select all the categories of a group, click **Select All** for the group. The group does not need to be expanded for you to select all categories in a group.
7. Type an optional **Note** to include useful information about this policy for future reference.
8. Click **Next**.
9. If you want to apply an exception list, in the **Specify Exception Lists** screen, select an approved HTTPS URL list name from the drop down list box. IWSVA tunnels HTTPS traffic from a URL in the exception list; that is, the encrypted content will not be decrypted for inspection.
10. Click **Save**.
11. In the **HTTPS Decryption Policies** screen, set the priority of the new policy (under the **Priority** column) by clicking the up or down arrow.  
The **Priority** setting determines which policy is applied if there are accounts belonging to two or more policies.

12. Click **Save**.
13. To immediately apply the policy, click **Deploy Policies**; otherwise, the policy is applied after the database cache expires.

---

**WARNING!** In proxy mode, IWSVA applies HTTPS decryption policies based on the client's browser domain. However in transparency mode, since IWSVA is unable to obtain client domain information, IWSVA applies HTTPS decryption policies to the CommonName in the server certificate.

---

## HTTPS Decryption Settings

Click **HTTP > HTTPS Decryption > Settings** to configure the following:

- Server certificate validation
- Client certificate handling
- Certificate authority

### Server Certificate Validation

In the Server Certificate Validation screen, enable server certificate validation and configure validation settings to automate certificate tests such as querying certificate revocation list and establishing certificate validity.

---

**Note:** If you disable certificate validation, clients can access any HTTPS Web sites without checking server certificates.

If a certificate does not pass a certificate validation test, clients can still choose to access a Web site through HTTPS connection. A warning screen displays on the client's browser.

---

#### To configure server certificate validation:

1. From the main menu, click **HTTP > HTTPS Decryption > Settings**. The Server Certificate Validation screen displays.
2. Select **Enable Certificate Verification** to check server certificates.
3. Select one or more of the following options:

- **Deny Certificates where the CommonName does not match the URL**—Select this option to deny a certificate if the CommonName does not match the accessed URL. IWSVA treats the certificate as invalid.
    - **Allow Wildcard-Certificates**—Select this option to allow and verify certificates whose CommonName is represented by a wildcard. Disable this option to deny any certificate with a CommonName expressed using wildcards.
  - **Deny expired or wrong purpose certificates**—Select this option to deny certificates that are expired or certificates that cannot be used for the intended purpose.
  - **Verify entire certificate chain**—Select this option to ensure that a given certificate chain (from the supplied certificate to the root Certificate Authority's certificate) is valid and trustworthy.
  - **Certificate revocation check by CRL**—Select this option to check whether a certificate is revoked (becomes invalid) by looking up the Certificate Revocation List (CRL).
4. Click **Save**.

## Client Certificate Handling

For many high-security applications, such as online banking, the Web server may require client certificates to authenticate the clients. Since IWSVA does not support Web sites that require client certificates, you can select to tunnel or block the connection in the Client Certificate Handling screen.

- **Tunnel**—Select this option to bypass HTTPS traffic. IWSVA will not decrypt the content for inspection.
- **Block**—Select this option to deny access to the remote server.

## Certificate Authority

By default, IWSVA acts as a private Certificate Authority (CA) and dynamically generates digital certificates that are sent to client browsers to complete a secure session for HTTPS connections. However, the default CA is not signed by a trusted CA on the Internet and the client browsers will display a certificate warning each time users access an HTTPS Web site. Although users can safely ignore the certificate warning, Trend Micro recommends using a signed certificate for IWSVA.

**To import a CA certificate:**

1. From the main menu, click **HTTP > HTTPS Decryption > Settings | Certificate Authority**.
2. Click **Browse** next to **Certificate** to select a certificate file. IWSVA supports certificates using base64-encoded format.
3. Click **Browse** next to **Private Key** to select the private key associated with the CA certificate. The private key is provided together with your certificate from the well-known CA.
4. Type the **Passphrase** if you provided this information when you first applied for the certificate.
5. Type the passphrase again the **Confirm Passphrase** field.
6. Click **Import CA**.

---

**Note:** IWSVA supports certificates using base64-encoded format only.

After importing a CA certificate, a certificate warning screen (*Figure 8-6*) may display on the end users machines, if they attempt to access a secured Web site. To avoid this behavior, add the related certificates to the Trusted Root Certificates Authorities list in the appropriate Web browser. See *Figure 8-7* for details.

---

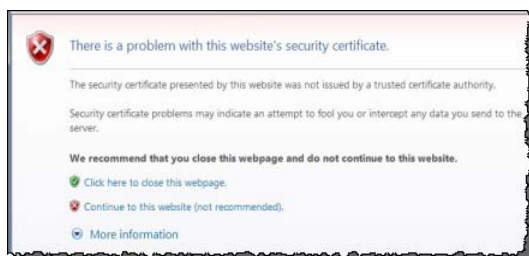

**FIGURE 8-6. Certificate Warning Screen**

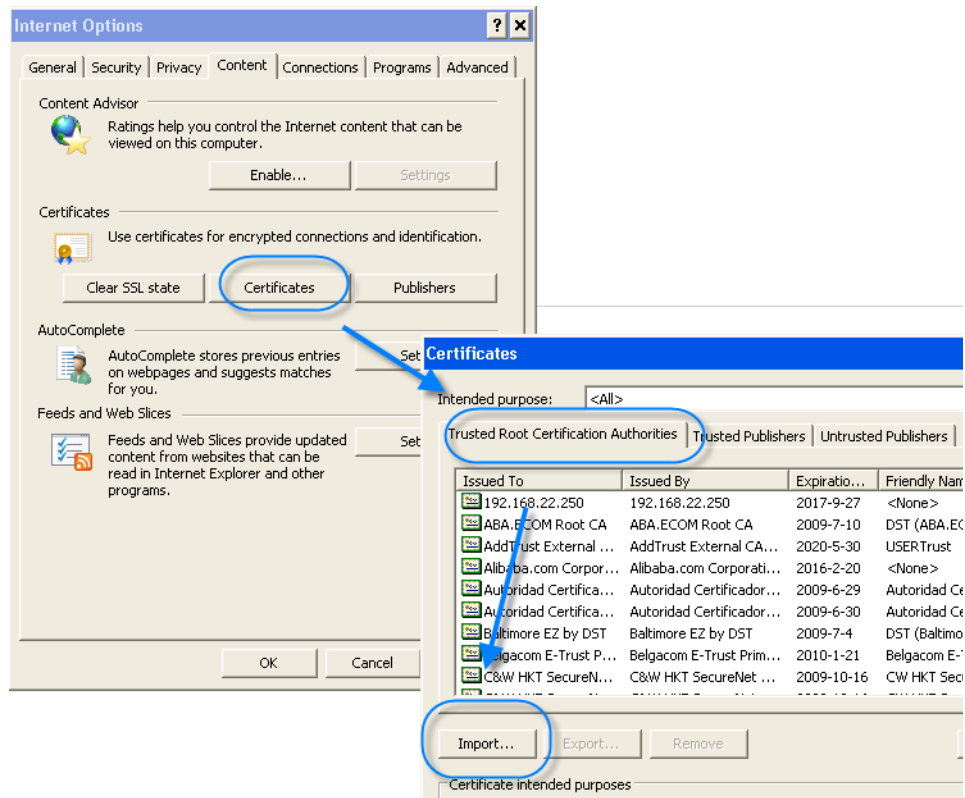

**FIGURE 8-7. Add a certificate to Trusted Root Certificate Authorities**

**To export a CA certificate (public key):**

1. From the main menu, click **HTTP > HTTPS Decryption > Settings | Certificate Authority**.
2. Click **Get Public CA Key**.
3. Follow the on-screen prompt to save the certificate file on your computer.

**To export CA private key:**

1. From the main menu, click **HTTP > HTTPS Decryption > Settings | Certificate Authority**.
2. Click **Get Private CA Key**.
3. Follow the on-screen prompt to save the key file on your computer.

## Creating and Modifying Advanced Threat Protection Policies

In addition to the default global and guest policies, you can create customized HTTP scanning policies for specified members of your organization.

**To create a new virus scan policy:**

1. Choose **HTTP > Advanced Threat Protection > Policies** from the main menu.
2. Select **Enable virus scanning** to enable virus scanning.
3. Select **Enable Advanced Threat Scan Engine** to enable the Advanced Threat scan engine.
4. Select **Enable Web Reputation** to enable Web Reputation.

---

**Note:** Web Reputation must be enabled at the global level to be used at the policy level.

---

5. Select **Enable Bot Detection** to enable Bot Detection.
6. Click **Add**.
7. Type a descriptive **policy name** in the “Create new policy” field.

Policy names that include references to the users or groups to which they apply (for example, “Virus Policy for Engineers” or “URL Filtering Policy for Researchers”) are easy to remember.

Account fields should support IPv6 addresses. You can define one rule for any IPv6 host, and this policy rule is triggered when the client accesses the HTTP sites through IWSVA.

When selecting available policies, both IPv4 and IPv6 policies will appear. In the Account field, acceptable account entries include a single IPv6 address, an IPv6 range, or an IPv6 mask similar to what has been supported with IPv4.



---

IWSVA supports the “Scan before delivering” feature with IPv6, and can automatically redirect the progress of IWSVA IPv6 or IPv4 addresses to the client based on the version of the client’s IP address.

- When a client uses an IPv4 address, IWSVA sends a redirect request with IWSVA’s IPv4 address.
- When a client uses an IPv6 address, IWSVA sends a redirect request with IWSVA’s IPv6 address.

8. Select the users to which this policy applies.

The options on this page depend upon the user identification method that you are using—either **IP address**, **Host name (modified HTTP headers)**, **IP Subsets**, or **User/group name authentication**. For more information about configuring the user identification method and defining the scope of a policy, see [Configuring the User Identification Method starting on page 7-6](#).

---

**Note:** Regardless of the user identification method you have configured, you can always enter IP addresses of the clients to which the policy applies.

---

9. When you have named your new policy and defined the account(s) to which it applies, click **Next** to proceed with defining HTTP virus scanning rules.

**To modify an existing Advanced Threat Protection policy:**

1. Click **HTTP > Advanced Threat Protection > Policies** from the main menu.
2. Click the name of the policy to modify.
3. Modify the Web Reputation rule, virus scanning rule, bot detection rule, the spyware scanning rule, policy exceptions, and the scanning action.

The specified scanning action applies to all specified rules.

**To add or remove users from an existing Advanced Threat Protection policy:**

1. Click **HTTP > Advanced Threat Protection > Policies** from the main menu.
2. Click the desired scan policy account.
3. From the **HTTP Scan Policies: Edit** screen, on the **Account** tab, either add or remove a user.

- To add a user, specify a user IP address in the **IP address** field or specify a range of users in the **From** and **To** fields under **IP range**. Click **Add** after specifying a user or range of users.
- To remove a user, click the trash can icon next to the user.

**To enable a HTTP scanning policy:**

- In any HTTP scanning policy configuration page, select **Enable policy**.

## Specifying Web Reputation Rules

Web Reputation rules are created at the policy level.

**To specify Web Reputation rules:**

1. Ensure that Web Reputation is enabled at the global level.  
Web Reputation must be enabled at the global level to use it at the policy level (**HTTP > Advanced Threat Protection > Policies | Enable Web Reputation** checkbox).
2. Ensure that Web Reputation is enabled at the policy level.  
Using the **Add** or **Edit** option for the **HTTP > Advanced Threat Protection > Policies | Web Reputation Rules** page, ensure that the **Use Web Reputation rule in this policy** check box is selected. This check box is selected by default.
3. Select **Use Page Analysis in this policy** to enable IWSVA to examine the Web site for malicious content and adjust the reputation score. For example, if malicious content is detected on a Web site, IWSVA will decrease its reputation score and block access if the score is below the configured sensitivity threshold.
4. Specify the URL blocking sensitivity level.  
Upon receiving the Web Reputation score, IWSVA determines whether the score is above or below the threshold. The threshold is defined by sensitivity level as configured by the user. Medium is the default sensitivity setting. This setting is recommended because it blocks most Web threats while not creating many false positives.
5. Either accept or disable the anti-pharming, anti-phishing, and C&C contact detections.  
By default, all detections are enabled. See [Anti-phishing, Anti-pharming, and C&C Callback Attempt Detection](#) on page 8-43.

## Anti-phishing, Anti-pharming, and C&C Callback Attempt Detection

Phishing attacks are emails designed to steal private information from you. These emails contain URLs which direct you to imposter Web sites where you are prompted to update private information, such as passwords and credit card numbers, social security number, and bank account numbers.

Pharming attacks are attempts to redirect you to imposter Web sites with the intention of stealing private information, which is usually financially related. Pharming compromises a DNS server by planting false information into the server, which causes a user's request to be redirected to an unintended location. Unfortunately, the Web browser displays what appears to be the correct Web site.

---

**Note:** Because the source of anti-phishing/pharming detection is Web Reputation and anti-phishing/pharming functions in an anti-threat capacity, it is therefore part of the Web Reputation Rule for a policy. And because Web Reputation at the policy level cannot function until enabled at the global level, anti-phishing/pharming is also disabled when Web Reputation is disabled globally.

---

In ICAP mode, IWSVA does not support anti-pharming.

---

Command and control callback attempt detection (C&C Callback) attacks are systems attempting to detect botnets by examining traffic content for IRC commands or by setting up honeynets.

## Custom Defense Settings

You can integrate IWSVA with the DDA sandbox to defend against offline custom-defense APT attacks from malicious programs through HTTP/HTTPS traffic.

ATSE engines can be used to scan for viruses and suspicious files. This engine is more aggressive than VSAPI engines. It can apply APT custom defense rules that can be configured in Custom Defense to identify APT detection. See **HTTP > Advanced Threat Protection > Custom Defense**.

## Enable Custom Defense

Click this check box to enable or disable IWSVA integration with the DDA server. If the DDA server is not recognized, IWSVA cannot save the settings.

## Settings for Virtual Analyzer C&C List

Enter the IP address, port, and API key of the Virtual Analyzer server. Click **Test Connection** to confirm proper integration.

## Actions

Select based on the file types you would like to sample submission. Select to block or monitor synchronized, blacklisted content by clicking “Enable generated Malicious entity feedback.” Save your changes.

## Web Reputation Settings

Web Reputation settings involve specifying the following:

- Whether to provide feedback on infected URLs to Trend Micro
- Whether to evaluate Web Reputation in a monitoring only mode (no URLs are blocked)

## Enabling and Disabling Web Reputation

IWSVA allows you to enable or disable Web Reputation at the global level and at the policy level. If you disable Web Reputation at the global level, then it is automatically disabled at the policy level.

### To enable and disable Web Reputation at the global level:

1. Click **HTTP > Advanced Threat Protection > Policies > Virus Scan Global Policy** and click the Web Reputation Rule tab.
2. From the Web Reputation Rules screen, select **Use Web Reputation rule in this policy** to enable Web Reputation. Clear the checkbox to disable it.

**To enable and disable Web Reputation at the policy level:**

1. Click **HTTP > Advanced Threat Protection > Policies > policy name** and click the **Web Reputation Rule** tab.
2. Select **Use Web Reputation rule in this policy** to enable Web Reputation or clear the check box to disable it for this policy.

**Managing Web Reputation Results**

IWSVA provides two options for managing Web Reputation results: (1) Provide feedback on infected URLs to help improve the Web Reputation database and (2) monitor the effectiveness of Web Reputation without affecting existing Web-access policies. One or all options can be selected.

**Feedback Option**

In addition to the current dynamic URL Blocking List, virus scan results can be fed back to the URL Local Cache and an external backend Rating Server. The Trend Micro Feedback Engine (TMFBE) provides a feedback mechanism for IWSVA to send back virus scan results to the backend Rating Server. The Feedback option is enabled by default.

---

**Note:** When using Upstream Proxy mode, you might need to configure the proxy server to explicitly allow the IWSVA IP address to access [www.trendmicro.com](http://www.trendmicro.com).

---

**Negative Results**

If the scan result from the Trend Micro virus scanning engine is negative, the infected URL is sent back to the following locations:

- Dynamic URL Blocking List
- URL Local Cache with an adjusted Web Reputation score
- TMFBE feedback buffer with VirusName and IntelliTrap Flag. When this buffer reaches ten entries or five minutes have passed from the last feedback, these URLs are sent to the backend Rating Server in a batch (each URL is sent sequentially).

### Positive Results

If the scan result from Trend Micro's virus scanning engine is positive, the URL in question is saved in the URL local cache. This prevents the same URL from getting scanned by Trend Micro's virus scanning engine twice.

### Monitor Only Option

The Monitor Only option gives you the opportunity to evaluate Web Reputation results. With this option selected, you are able to monitor Web Reputation results from the URL Blocking Log or Security Risk Report. The results only include the URLs filtered by Web Reputation, anti-phishing and anti-pharming. Because you are only monitoring Web Reputation results, no URL blocking occurs and URLs are passed to clients.

By default, the Monitor Only option is disabled.

## Clearing the WRS/URL Cache

When a user attempts to access a URL, IWSVA retrieves information about this URL from a remote database—the Web Reputation database—and stores the retrieved information in a local WRS/URL cache. Having the Web Reputation database on a remote server and building the local WRS/URL cache with this database information reduces the overhead on IWSVA and improves performance.

The following are the information types the WRS/URL cache can receive from the Web Reputation database for a requested URL:

- Web category
- Pharming and phishing flags used by anti-pharming and anti-phishing detection
- Web Reputation rating results used to determine whether or not to block a URL (see [Specifying Web Reputation Rules on page 8-42](#))

The URL cache keeps frequently accessed URLs in cache for quick retrieval. Clear the cache only if a new URL query is necessary or if the cache size is affecting performance.

---

**Note:** Clearing the cache stops and restarts the HTTP scanning daemon, which may interrupt IWSVA service.

---

**To clear the WRS/URL cache:**

1. From the main menu, click **HTTP > Configuration > WRS/URL Cache**.
2. Click **Clear Cache**.

## Using the Content Cache

Web content caching is the caching of Web objects (such as HTML pages and images) to reduce bandwidth usage, server load, and perceived lag. A Web cache stores copies of objects passing through it. Subsequent duplicate requests may be satisfied from the cache if certain conditions are met. Cached objects will be re-scanned by IWSVA.

The Content Cache capability provides users who access the Web through IWSVA with a quicker experience while saving bandwidth.

---

**Note:** This feature is available in Forward Proxy and WCCP modes. The Content Cache feature is grayed out and will not function in other modes.

---

With the Content Cache feature, administrators enable or disable the IWSVA in-box cache and manage caching through Web console. It also generates cache statistics.

---

**Note:** The Content Cache feature cannot be disabled from the CLI.

---

## Enabling/Disabling the Content Cache

**To enable/disable the Content Cache feature:**

1. Go to **HTTP > Configuration > Content Cache**.
2. Select the **Enable Content Cache** check box at the top of the page to enable the Content Cache feature. (See [Figure 8-8](#).)
3. Click **Save**.
4. Clear the **Enable Content Cache** check box to disable the Content Cache feature.

- Click **Save**.

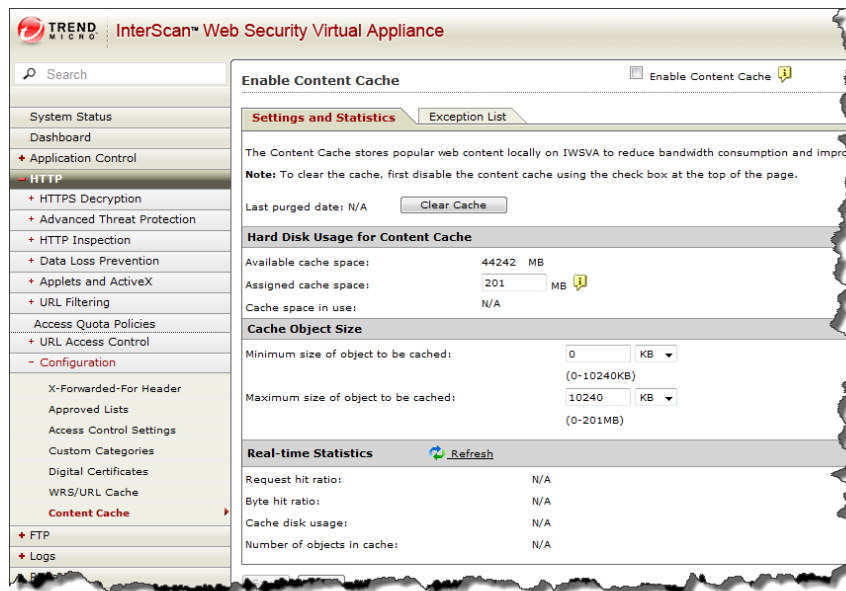

FIGURE 8-8. Content Cache screen

## Clearing the Content Cache

### To clear the Content Cache:

- Disable the Content Cache feature before clearing the cache.  
The Clear Cache button is disabled when the Content Cache feature is enabled.
- Click **Clear Cache**. You receive the following warning:  
“It could take a significant amount of time to clear a large cache.  
Are you sure you want to clear the cache?”
- Click **OK**. A progress bar displays during the cache clearing process.  
The Clear Cache button and the Enable Content Cache checkbox are both disabled until the clearing process ends. After the cache clears, the “Last purged date” updates.



## Managing the Content Cache

Administrators can configure the following content cache areas:

- Hard disk usage for the Content Cache
- Cache object size

### To manage the Content Cache:

1. Go to the **Hard Disk Usage for Content Cache** section of the Content Cache Settings and Statistics tab.
2. Enter a quantity for the **Cache space size**. (See *Figure 8-8*.)

Administrators can adjust the amount of disk space used to store the cached content. A larger cache volume will allow more Web objects to be cached. A smaller cache partition will reduce the number of cacheable objects. If you set the cache volume too small and run out of disk space for caching, the hit ratio may decrease as IWSVA will rely more on real-time content retrieval and less on locally cached content.

Perhaps your VA total partition space is 40GB within binaries, files and log occupying 15GB. Currently, your “Assigned cache space” setting may be 10GB, and the “Cache space in use” may be 5GB. The screen show:

- Available cache space: 25,000MB [40GB (total space) - 15GB (logs, miscellaneous)]
- Assigned cache space: 10,000MB
- Cache space in use: 5,000MB

In this case, the “Assigned cache space” setting could be increased to a maximum of 25GB.

3. To tune the minimum and maximum size values, select the amount and unit of measure (KB/MB) for the following:
  - Minimum size of object to be cached (default 0KB) Range allowed is: 0-10240KB/10MB
  - Maximum size of object to be cached (default 10MB) Range allowed is: 1-4096MB/4194304KB

The minimum size and maximum size of cached objects will allow you to tune the caching performance. If the minimum size of cached objects is set too small, the cache service will use local resources to cache content that can be retrieved more quickly from the Internet and this can slow performance. If the minimum size is set

too large, the cache may not contain popular objects that can save bandwidth and reduce latency.

This is similarly true for the maximum size of cacheable objects. Depending on the type of Web pages users access what type of cacheable objects they contain, the performance will vary. You can experiment with the minimum and maximum size values to fine tune the cache performance and hit rate for your environment. Trend Micro recommends starting with the default values and then fine tuning as necessary for your environment.

4. Click **Save**.

## Content Cache Real-time Statistics

The real-time statistics for the Content Cache feature include:

**TABLE 8-5. Real-time Statistics definitions**

CACHE STATISTICS	DESCRIPTION
Request hit ratio	The percentage of HTTP requests that result in a cache hit.
Byte hit ratio	Compares the number of bytes received from origin servers to the number of bytes sent to clients. When received bytes are less than sent bytes, the byte hit ratio is positive. However, a negative byte hit ratio may occur if clients abort multiple requests before receiving the entire response.
Cache disk usage	The amount of data currently cached on disk.
Number of objects in cache	Represents the number of objects cached.

---

**Note:** Real-time statistics for the Content Cache feature will not refresh automatically. You must click the Refresh link for the statistics to update.

---

## Content Cache Exception List

When administrators do not want to cache a specific URL, they can add the URL to the cache exceptions list. The behavior here is the same as the URL blocking list.

Administrators can add a Web site, URL keyword, or string to exceptions list. URLs that match the list will not be cached by IWSVA.

You can have IWSVA block certain Web pages, domains, and URLs from being stored in the content cache. URLs blocked from the Content Cache are not policy based—it affects everyone in the organization.

---

**Note:** Content caching is supported in Forward Proxy and WCCP modes.

---

Blocking URLs from the Content Cache combats large Web sites from being cached and taking up cache space that is more efficiently used for other common Web sites.

- **Enable Content Cache**—Enable or disable Content Cache (click Save after enabling or disabling content caching).
- **Match**—Enter an exact Web site, a keyword or phrase, or a string of characters in the field, and then configure IWSVA with how to apply the match. URLs blocked from the content cache supports both the ? and \* wildcard.
- **Web site**—Limits the search to the string as a whole; used with one or more wildcards, this type of blocking can be especially useful for preventing entire Web sites from being cached. There is no need to include http:// or https:// in the URL (as it is automatically stripped).
- **URL Keyword**—Looks for any occurrence of the letters or numbers within a URL, and will match regardless of where the string is found (the string “sex” would be considered a match for “http://www.encyclopedia/content/sexton.htm” and the page blocked. Using wildcards with URL Keywords greatly increase the chance of false positives.
- **String**—Limits the search to the string as a whole; for example, to target a specific site, page, file, or other particular item.

- **Import Blocked Content Cache List and Exceptions**—You can import an existing list of URLs that you want to block or exempt from content caching. For example, if you have a list of URLs from a third-party vendor, Web Manager, or related software program, or a list of sites you have compiled using a text editor, you can import the list rather than enter them one-by-one in the Match field. Imported lists must conform to a defined standard.

### Content Cache Exceptions List Format

The Content Cache exception list uses the following format to import exception lists.

```
[no_cache]
www.example.com/subdomain*
example.com
www.example.com/c.jpg
www.example.com*
www.example1.com
www.example2.com
```

## HTTP Virus Scanning Rules

IWSVA administrators can configure which file types to block and scan, and how compressed and large files are handled.

See **HTTP > Advanced Threat Protection > Policies** | **policy name** on the **Virus/Malware Scan Rule** tab.

### Advanced Threat Scan

Select to monitor or block threats during scans.

### Specifying File Types to Block

You can identify the types of files to block for security, monitoring, or performance purposes. Blocked files are not received by the requesting client or scanned—requests to retrieve a blocked file type are not executed. You have the option of blocking file types such as Microsoft Office documents, images, executables, audio/video files, Java applets, archives, or other files types that you specify.

**To specify which file types to block:**

1. While adding or editing a policy, under **Block These File Types**, check the box of the file types to block. This will block all files in that category.
2. To choose to unblock file types within a selected category, click the Show Details link.
3. Uncheck the files that should not be blocked.

**Specifying File Types to Scan**

IWSVA is equipped with the following HTTP scanning capabilities:

- IntelliScan
- True-file type detection
- IntelliTrap

---

**Note:** For the highest level of security, Trend Micro recommends scanning *all* files.

---

**About IntelliScan**

Most antivirus solutions today offer you two options to determine which files to scan for potential risks. Either all files are scanned (the safest approach), or only those files with certain file extensions considered the most vulnerable to infection are scanned. However, recent developments that disguise files by changing their extensions renders this latter option less effective. *IntelliScan* is a Trend Micro technology that identifies a file's "true-file type," regardless of the file name extension.

---

**Note:** IntelliScan examines the header of every file, but based on certain indicators, selects only files that it determines are susceptible to virus infection.

---

**About True-file Type**

When set to scan *true-file* type, the scan engine examines the file header rather than the file name to ascertain the actual file type. For example, if the scan engine is set to scan all executable files and it encounters a file named `family.gif`, it will not accept that the file is a graphic file and skip scanning. Instead, the scan engine opens the file header and

examines the internally registered data type to determine whether the file is indeed a graphic file, or, for example, an executable that has been deceptively named to avoid detection.

True-file type scanning works in conjunction with Trend Micro IntelliScan, to scan only those file types known to be of potential danger. These technologies can mean a reduction in the overall number of files that the scan engine must examine (perhaps as much as a two-thirds reduction), but it comes at the cost of potentially higher risk.

For example, .GIF and .JPG files make up a large volume of all Web traffic. It is possible for a malicious hacker to give a harmful file a “safe” file name to smuggle it past the scan engine and onto the network. The file could not run until it was renamed, but IntelliScan would not stop the code from entering the network.

#### **To select which file types to scan:**

IWSVA can scan all files that pass through it, or just a subset of those files as determined by true-file type checking (IntelliScan) or the file extension. In addition, individual files contained within a compressed file can also be scanned.

1. Select the files to scan:
  - To scan all file types, regardless of file name extension, select **All scannable files**. IWSVA opens compressed files and scans all files within. This is the most secure, and recommended, configuration.
  - To use true-file type identification, select **IntelliScan**. This configuration scans file types that are known to harbor viruses by checking the file's true-file type. Because checking the true-file type is independent of the filename's extension, it prevents a potentially harmful file from having its extension changed to obscure its true-file type.
  - You can explicitly configure the types of files to scan or skip, based on their extensions, to work around possible performance issues with scanning all HTTP traffic. However, this configuration is not recommended because the file extension is not a reliable means of determining its content.

To scan only selected file types, select **Specified file extensions** and then click the list. (Trend Micro does not recommend this setting.) The **Scan Specified Files by Extension** screen opens. The default extensions list shows all file types that are known to potentially harbor viruses. This list is updated with each virus pattern file release. On the **Scan Specified Files by Extension** screen, add or exclude additional extensions in the **Additional Extensions** and **Extensions to Include** fields.

Enter the extension to scan or exclude from scanning (typically three characters), without the period character. Do not precede an extension with a wildcard (\*) character, and separate multiple entries with a semicolon.

Click **OK** when you are finished. The screen closes.

2. You can configure IWSVA to selectively bypass certain MIME content-types. Some file types, such as RealAudio or other streaming content, begin playing as soon as the first part of the file reaches the client machine and does not work properly with the resulting delay. You can have IWSVA omit these file types from scanning by adding the appropriate MIME types to the **MIME content-types to skip** list on the **Virus Scan Rule** tab. Type the MIME content-type to bypass in the **MIME content-type to skip** field (for example, image, audio, application/x-director video, and application/pdf). See Appendix B, *Mapping File Types to MIME Content-types* for more information.

You can also enable the **Enable MIME type validation** check box to allow true file type scanning. This option enables a true file type check on the MIME stream. However, not all MIME types can be accurately detected. If false positives occur, disable Mime Type Validation and Content Type will be used instead.

**Note:** Trend Micro recommends minimizing the list of MIME content-types to skip to reduce the risk of virus infection. Also, Trend Micro does not recommend skipping any MIME content-types when large file handling is enabled, because it's possible for a MIME content-type to be forged.

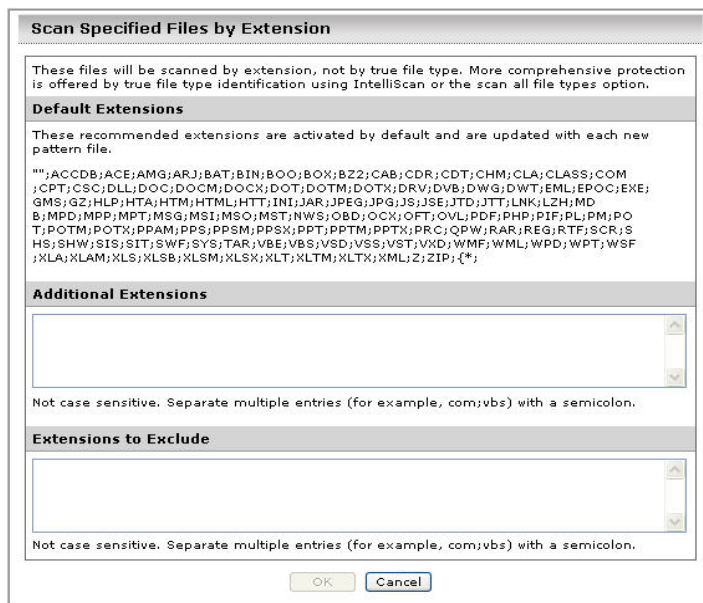

**FIGURE 8-9. The Recommended Extensions to Scan are Updated with Each New Pattern File**

### About IntelliTrap

IntelliTrap detects potentially malicious code in real-time, compressed executable files that arrive with HTTP data. Virus writers often attempt to circumvent virus filtering by using different file compression schemes. IntelliTrap provides heuristic evaluation of compressed files that helps reduce the risk that a virus compressed using these methods enters a network through the Web.



IntelliTrap has the following options:

- Can be enabled or disabled in the **Virus Scan Rule** tab for each scan policy. (IntelliTrap is enabled by default.)
- Malicious, compressed executable files receive the actions specified in the Action tab.

**To enable / disable IntelliTrap:**

- Click **HTTP > Advanced Threat Protection > Policies | <policy name> | Virus/Malware Scan Rule** tab and select the **Enable IntelliTrap** check box in the IntelliTrap section.

For more IntelliTrap information, see [IntelliTrap Pattern and IntelliTrap Exception Pattern Files on page 4-7](#).

## Priority for Virus/Malware Scan Configuration

IWSVA scans according to the following priority:

1. MIME content-types to skip
2. File types to block
3. File types to scan

## Configuring Compressed File Scanning Limits

Compressed file scanning limits can be configured for each policy (click **HTTP > Advanced Threat Protection > Policies > policy** and click the **Virus/Malware Scan Rule** tab). IWSVA opens and examines the contents of compressed files according to the criteria specified in the HTTP virus scanning configuration screen. IWSVA decompresses the files according to the configurable limits (number of files in the compressed archive, size of the compressed file, number of compressed layers, and the compression ratio).

**To configure the compressed file scanning limits:**

Under **Compressed File Handling**, configure the following settings:

- **Action:** Select an action (**Pass**, **Block**, or **Quarantine**) you want IWSVA to take when it detects a compressed file violation.
- **Applies to:** Select one of the following options.
  - **All compressed files:** Match all requests to download compressed files.

- **Compressed files if...:** Match only requests to download compressed files that exceed the configured criteria. Type values for the following parameters:
  - Decompressed file count exceeds (default is 50000)
  - Size of a decompressed file exceeds (default is 200MB)
  - Number of layers of compression exceeds (range is 0-20; default is 10)
  - Enable/disable when compression ratio exceeds 99% (default is disabled)

IWSVA applies the selected action on a compressed file that meets the specified conditions at the gateway and the file is not scanned. For example, suppose your settings appear as shown in *Figure 8-10*:

**Compressed File Handling**

Action:

Applies to:  All compressed files  
 Compressed files if:

Decompressed file count exceeds:  (1-999999)

Size of a decompressed file exceeds:   (1-99999)

Number of layers of compression exceeds:  (0-20)

Compression ratio exceeds 99%. (Files with less than 99% compression ratio are automatically allowed by IWSVA)

**FIGURE 8-10. “Decompression percent” can be used to prevent a denial-of-service (DoS) attack against the IWSVA device**

A compressed file that has more than 10 layers of compression or contains more than 10000 files that will not pass through the gateway.

## Handling Large Files

For larger files, a trade-off must be made between the user’s experience and expectations, and maintaining security. The nature of virus scanning requires doubling the download time (that is, the time transferring the entire file to IWSVA, scanning the file, and then transferring the entire file to the client) for large files. In some environments, the doubling of download time might not be acceptable. There are other factors such as network speed, and server capability that must be considered. If the file is not big enough to trigger large-file handling, the file is scanned as a normal file.

Consider configuring large file handling if your users experience browser time-outs when trying to download files. There are two large file scanning options:

- [Scan Before Delivering \(Progress Page\) on page 8-59](#)
- [Deferred Scanning on page 8-61](#)

### **Scan Before Delivering (Progress Page)**

When IWSVA is configured to use the **Scan before delivering** scanning option, requested files are not passed to the client until scanning is finished. A progress page is generated to prevent the browser from timing out and to inform the user that scanning is in progress to prevent them from thinking that the connection is hung.

**Note:** For large file handling, IWSVA uses the progress page. The progress page uses JavaScript and a pop-up window to display the download progress. If your desktop security policy has pop-up blocking enabled or JavaScript disabled, then the progress page does not function and scanning is prevented.

For the progress page to work, IWSVA needs to determine to which externally visible IP address the clients connect. Using 127.0.0.1 causes a problem. If a message about the progress page appears, add the machine IP address to `iscan_web_server` so that the host name does not resolve to 127.0.0.1 (for example, `iscan_web_server=1.2.3.4:1812`) or modify the `/etc/hosts` file.

---



Trend Micro InterScan Web Security Virtual Appliance 5.5: IWSVA126

**FIGURE 8-11. “Scan before delivering” Large File Handling Progress Window**

---

**Note:** Some Internet applications (YouTube, Windows Update, streaming, and others) are programmed to receive a certain amount of data on the client side within a certain time frame (for example, 20 percent of data or 1MB of data in 90 seconds). When IWSVA is configured to use the Scan feature before delivering the scanning option, some requested files will not be passed to the client until the scanning is completed. In this case, it is likely that the Internet application could detect a transmission failure because the client side does not receive enough data in time. Then, the client side will not be able to complete the video file or streaming file.

---

### Deferred Scanning

When IWSVA is configured to use the **Deferred scanning** option, part of the file is passed to the requesting client while IWSVA scans the remainder of the file. The partial file remains in the client's temporary directory until scanning concludes and the last byte of the file is delivered.

Instead of using a specified data size, IWSVA uses a percentage to define how much data is downloaded at a time. At most every two seconds, IWSVA sends a specified percentage of received data to the browser. The last chunk of data is not larger than 4KB and is sent to the browser before the scan is finished.

For the data download percentage, you can specify either 20, 40, 60, 80, or 100. The default percentage is 60. The actual percentage of data sent to the browser can be much smaller than the percentage specified.

---

**Note:** Large file handling does not work when using the Blue Coat Port 80 Security Appliance in ICAP mode. In addition, when using the Blue Coat security appliance in ICAP mode, when the client downloads a large virus-infected file, the client browser may not show the virus blocking notification page. Instead, the client browser will show "Page cannot be displayed." If IWSVA is configured as an HTTP proxy in-line with the Blue Coat appliance, however, large file handling functions.

---

External data received by IWSVA is sent to the browser in smaller chunks without scanning. The last chunk is sent to the browser to complete the download only after the entire set of data is received and scanned. Sending smaller chunks not only maintains the IWSVA-Web browser connection, but also keeps end-users posted of the download progress.

Large file handling can be set for each policy (click **HTTP > Advanced Threat Protection > Policies > policy** and click the **Virus/Malware Scan Rule** tab).

The screenshot shows the 'Large File Handling' configuration panel. It has two main sections: 'Large File Handling' and 'Quarantined File Handling'. In the 'Large File Handling' section, there are three checked options: 'Do not scan files larger than' (set to 2048 MB), 'Enable special handling' (set to 512 MB), and 'Scan before delivering'. Under 'Enable special handling', there are two radio button options: 'Scan before delivering' (selected) and 'Deferred scanning'. Below these is a percentage field set to 60%. The 'Quarantined File Handling' section has one checked option: 'Encrypt quarantined files'.

**FIGURE 8-12. For special handling of large files, there are two options to choose from: (1) scan before delivering and (2) deferred scanning**

Disable large file scanning by choosing the **Do not scan files larger than** option to reduce performance issues when downloading very large files. This allows you control over their integrity.

#### To disable scanning large files:

- Under **Large File Handling**, select the **Do not scan files larger than** check box and then configure the file size over which files are not scanned. The default is 2048MB.

Trend Micro does not recommend disabling the scanning of any files, even large ones, because it introduces a security vulnerability into your network.

#### To use large file handling for HTTP scanning:

1. In the **Large File Handling** section, select **Enable special handling**, and then type the file size (in KB or MB) to be considered a large file. The default value is 512KB.
2. Select the type of large file-handling to use:
  - **Scan before delivering**: Shows progress while scanning, and then loads the page afterwards (default setting)
  - **Deferred scanning**: Loads part of the page while scanning; stops the connection if a virus is found
3. Click **Save**.

### Important Notes for Large File Handling

- Violations of the large file handling policy displays a user notification in the requesting client's browser. See the example in [Figure 8-13](#).

The file p1\_100M.zip is downloading.  
 After the download is complete, the file will be scanned.  
 Navigating to another page will interrupt the download, which will then need to be restarted from the beginning.

## Download Status

Transferred data bytes: 112397136  
 Scanning...>>>

---

**HTTP/HTTPs Download File Blocked**

Access to this web site content was blocked by the IT HTTP/HTTPs Scan Policy because violation of a compressed file restriction was detected from this URL.

**Event Details:**  
 URL: http://10.204.170.87/TESTDATA/virus/NonCleanable/p1\_100M.zip  
 Action: deleted

**Details:**  
 -- File: p1\_100M.zip, security warning: **Exceed\_File\_Count\_Limit**  
 The file is deleted.

If you believe this file was blocked in error, please contact your IT staff to resolve this issue.

---

Trend Micro InterScan Web Security Virtual Appliance 5.1: junbo1214

**FIGURE 8-13. Notification after Completing Scanning and Downloading the File**

- Large file special handling only applies to HTTP scanning, FTP scanning, and FTP over HTTP through the HTTP proxy. It does not apply to FTP over HTTP for ICAP traffic. Time-out issues may occur while downloading large files using FTP over HTTP.
- When using the deferred scanning method, IWSVA does not delete files subsequently found to be infected in the first affected client.

## Quarantined File Handling

If you choose to quarantine files that IWSVA detects as malicious, you can optionally choose to encrypt the files before moving them to the quarantine folder by selecting the **Encrypt quarantined files** check box. This prevents the files from being inadvertently executed or opened. Note that encrypted files can only be decrypted by a Trend Micro Support engineer.

After configuring the HTTP virus scanning rules in the **HTTP > Advanced Threat Protection > Policies > Add Policy/Edit Policy** screen, click **Next** to move on to the Spyware/Grayware scanning rules.

## Spyware and Grayware Scanning Rules

In addition to computer viruses, the IWSVA pattern files include signatures for many other potential risks. These additional risks are not viruses, because they do not replicate and spread. However, they can perform unwanted or unexpected actions, such as collecting and transmitting personal information without the user's explicit knowledge, displaying pop-up windows, or changing the browser's home page.

IWSVA can be configured to scan for the following additional risks:

- **Spyware**—Software that secretly collects and transmits information without the user's explicit knowledge or consent
- **Dialers**—Software that secretly dials a telephone number, typically an international or pay-per call number, through the user's modem.
- **Hacking tools**—Software that can be used for malicious hacking purposes.
- **Password cracking applications**—Software designed to defeat computer passwords and other authentication schemes.
- **Adware**—Software that monitors and collects information about a user's browsing activities to display targeted advertisements in the user's browser or through pop-up windows.
- **Joke programs**—Programs that mock computer users or generate some other sort of humorous display.
- **Remote access tools**—Programs designed to allow access to a computer, often without the user's consent.



- **Others**—Files that do not fit into the other additional risks classifications. Some of these might be tools or commercial software that have legitimate purposes, in addition to having the potential for malicious actions.

**To scan for spyware, grayware, and other non-virus additional risks:**

1. Click **HTTP > Advanced Threat Protection > Policies > policy** and click the **Spyware/Grayware Scan Rule** tab. Under **Scan for Additional Threats**, select the types of additional risks to be detected.

To scan for all additional risks that have signatures in the pattern file, check **Select all**.

2. Click **Next** to configure the actions against security risks.

**Scan Policy: Add Policy** ?

Policy List > (Test) ☑ Enable policy

1. Select Accounts
2. Specify Web Reputation Rules
3. Specify Virus Scan Rules
- 4. Specify Spyware/Grayware Scan Rules**
5. Specify Exception Lists
6. Specify Action

**Scan for Additional Threats:**  Select all

<input type="checkbox"/> Spyware	<input type="checkbox"/> Adware
<input type="checkbox"/> Dialers	<input type="checkbox"/> Joke programs
<input type="checkbox"/> Hacking tools	<input type="checkbox"/> Remote access tools
<input type="checkbox"/> Password cracking applications	<input type="checkbox"/> Others ⓘ

**FIGURE 8-14.** Spyware, grayware and additional threat scan configuration

## X-Forwarded-For HTTP Headers

The X-Forwarded-For (XFF) HTTP header is a de facto standard for identifying the originating IP address of a client connecting to a Web server through an HTTP proxy or load balancer. X-Forwarded-For header are supported by most proxy servers, and IPv6 X-Forward-For headers are supported in IWSVA. The headers can be parsed to access the client's IPv6 addresses similar to the behavior of IPv4 addresses.

IWSVA also handles three actions for IPv6 access similar to IPv4, including the “Keep X-Forwarded-For header intact” feature, the “Append the IP address where IWSVA receives the request” feature, and the “strip X-Forwarded-For header” feature.

- When IWSVA receives an HTTP request with an XFF header, it parses the XFF header to get the original client IP address and use the IP address to do a policy match.
- When IWSVA forwards an HTTP request, it takes the action configured by the administrator on the XFF HTTP header. (See [Table 8-6](#).)

---

**Note:** IWSVA does not support parsing XFF headers for HTTPS traffic.

---

**TABLE 8-6. Available actions for XFF HTTP headers**

ACTION	DESCRIPTION
Keep	IWSVA does not make any changes to the XFF HTTP header.
Append	IWSVA adds the IP address of last hop into the XFF HTTP header. If the XFF HTTP header does not exist, IWSVA creates one.
Strip	(Default) IWSVA removes the XFF HTTP header from the HTTP request and prevents the privacy information of client from leaking upstream.

See [Table 8-7](#) to verify that your deployment scenario works with the XFF HTTP headers.

**TABLE 8-7. Deployment scenarios using X-Forwarded For HTTP headers**

DEPLOYMENT MODE	PARSES XFF	ACTION: KEEP	ACTION: ADD IP ADDRESS	ACTION: REMOVE	NOTES
Forward Proxy	Yes	Yes	Yes	Yes	

**TABLE 8-7. Deployment scenarios using X-Forwarded For HTTP headers (Continued) (Continued)**

DEPLOYMENT MODE	PARSES XFF	ACTION: KEEP	ACTION: ADD IP ADDRESS	ACTION: REMOVE	NOTES
Bridge	Yes	Yes	N/A	Yes	This mode is transparent and does not need to add and IP address in the header.
WCCP	Yes	Yes	Yes	Yes	
Simple Transparency	Yes	Yes	Yes	Yes	
ICAP	N/A	N/A	N/A	N/A	IWSVA acts as an ICAP server. It does not communicate with the client and server. The IP address is provided by the ICAP client with an X-Client-IP header
Reverse Proxy	N/A	N/A	N/A	N/A	XFF HTTP headers are not supported in this mode.

## Configuring X-Forwarded-For HTTP Headers

In IWSVA, there are mainly two scenarios to configure:

- Enabling or disabling the parsing of XFF HTTP headers
- Configuring the action taken on the XFF HTTP header (if enabled.)

**To configure the XFF HTTP header module settings:**

1. Go the **HTTP > Configuration > X-Forwarded-For Header**.
2. Enable or disable parsing of the XFF HTTP.
  - To enable, select **Enable** from the drop-down list.
  - To disable, select **Disable** from the drop-down list.
3. If parsing is enabled, set the action to **Keep** (default) the X-Forwarded-For header intact, **Append** the IP address where the IWSVA receives the request, or **Strip** the X-Forwarded-For header. (See [Table 8-6](#).)
4. Click **Save**.

## Specifying Bot and C&C Contact Detection Rules

In order for you to monitor and analyze possible bot behavior within your network environment, rather than directly block the connection, you can specify whether to “Block” or “Monitor” an action when a bot detection rule has been matched. See **HTTP > Advanced Threat Protection > Policies | policy | Bot/C&C Detection Rule** tab. As with all Web Reputation policies, you have the ability to Add, Delete, Modify, or Deploy a Bot/C&C Detection policy.

## Specifying the Exceptions List

See **HTTP > Advanced Threat Protection > Policies | policy | Exceptions** tab.

The following describes the type of exception list you can apply to a policy:

- **URL exception list**—contains a list of Web site URLs that you want to exempt from a URL filtering policy, HTTPS decryption policy, Applet/ActiveX security policy, or the WRS rule and file type blocking in an HTTP scanning policy.
- **File name exception list**—files that you want to exempt from file type blocking.

In addition, you can configure IWSVA to bypass virus/spyware scanning and compressed file handling action on an approved list. This could cause security holes when this approved Web site has been hacked to inject malicious code into the Web site. IWSVA addresses this issue by enabling the virus/spyware scan feature as the default. As such, the Web page is always scanned even when a security policy determines that the Web site is within its approved list.

You can apply an exception list in the Exceptions screen. For HTTP and FTP scanning policies, you can also apply a filename exception list. You can create new exception lists in the Approved Lists screen (see *Creating Exception Lists* on page 8-70 for more information).

The following describes the options in the Exceptions screen:

- **Approved URL list**—Select the name of the approved URL list to be exempted from a URL filtering policy, HTTPS decryption policy, Applet/ActiveX security policy, or the WRS rule and file type blocking in an HTTP scanning policy.
- **Approved file name list**—Select a file name list to be exempted from file type blocking. You can apply a file name exception list to an HTTP scanning policy or an FTP scanning policy. This option is not available for Applets and ActiveX policies and URL filtering policies.
- **Do not scan the contents of selected approved lists**—Select this option if you do not want to scan the contents of the URLs or files in the approved lists for viruses. Compressed file handling is not available when this option is selected.

HTTP Scan Policy: Add Policy

Policy List > (test)  Enable policy

1. Select Accounts
2. Specify Web Reputation Rules
3. Specify Virus Scan Rules
4. Specify Spyware/Grayware Scan Rules
5. Specify Exception Lists
6. Specify Action

**Policy Exceptions**

Approved URL list: Test Approved URL List

Approved file name list: Test File Name List

Do not scan the contents of selected approved lists

Note: Approved list is defined at HTTP > Configuration > Approved Lists.

Previous Next Cancel

FIGURE 8-15. Configuring policy exceptions

## Creating Exception Lists

You can create a new URL and file name exception list in the Approved Lists screen.

### To configure a URL exception list:

1. Select **HTTP > Configuration > Approved Lists** from the main menu and click the **URL Lists** tab.
2. Click **Add** and specify a name, the match type or, if preferred, import the URL exception list.
  - **List Name**—Type a brief but descriptive name for the approved list.
  - **Match**—Type a Web site, a keyword or phrase, or a string of characters in the field. This field supports both the ? and \* wildcards. Entries in this field are added one-by-one to the Approved List.
3. Select the option that corresponds to what you typed in the Match field:
  - **Web site**—Limits the search to the string as a whole; used with one or more wildcards, this type of exemption rule can be especially useful for allowing access to an entire Web site. There is no need to include http:// or https:// in the URL (it is automatically stripped).
  - **URL keyword**—Looks for any occurrence of the letters and/or numbers within a URL, and will match regardless of where the string is found (the string “partner” would be considered a match for “http://www.playboy.com/partner.htm” and the URL exempted). Using wildcards in this field greatly increases the chance of false positives and unexpected results.
  - **String**—Limits the search to the string as a whole; for example to target a specific site, page, file, or other particular item.

- 
- Note:**
- For HTTPS decryption policies, the strings to match vary depending on whether you set IWSVA in the proxy or transparency modes.
  - In the proxy mode, IWSVA matches the domain names, not the full URL. Thus, you only need to specify the domain names.
  - In the transparency mode (WCCP or bridge mode), IWSVA matches the CommonName in the server certificates received.
  - For HTTPS standard ports, IWSVA matches the CommonName.
  - For HTTPS non-standard ports, IWSVA matches CommonName:Port
- 

- **Import approved list**—You can import an existing list of URLs that you want exempt from virus scanning or filtering (done by the URL Filtering module). For example if you have a list of URLs from the Trend Micro WebManager, or URLs you have compiled using a text editor, you can import the list rather than enter them one-by-one. Import lists must conform to a defined standard. See [Approved List Formats](#) on page 8-72.

4. Click **Save**.

**To configure a file name exception list:**

1. Select **HTTP > Configuration > Approved Lists** from the main menu and click the **File Name Lists** tab.
2. Click **Add** or **Edit** and specify the match type or import the exception list.
  - **List Name**—Type a brief but descriptive name for the approved list.
  - **Match**—Enter a file name with the file extension or a file extension in the field. This field supports the \* wildcard. Entries in this field are added one-by-one to the Approved List.
  - **Import approved list**—You can import an existing list of file names that you want exempt from virus scanning. For example if you have a list of file names from Trend Micro's Web site, or file names that you have compiled using a text editor, you can import the list rather than enter them one-by-one. Import lists must conform to a defined standard. See [Approved List Formats](#) on page 8-72.
3. Click **Save**.

## Approved List Formats

IWSVA supports two types of approved lists: URL and file name. The list formats for each type is described below.

---

**Note:** Approved lists using the [approved] format cannot be imported. Blocked and allowed lists using the [blocked] and [allowed] formats can be imported.

---

### Approved URL List Format

An approved URL list can be any ASCII text file containing the header:

```
[approved]
```

There is no limit to the number of URLs you can include in an approved list. Delimit separate Web addresses, URLs, and/or strings using a line break. Approved-lists support the following \* and ? wildcards.

Sample file:

```
[approved]
www.good-job-habits.com/*
www.business-productivity.com/*
```

### File Name List Format

A file name approved List can be any ASCII text file containing the header:

```
[approved]
```

There is no limit to the number of file names you can include in an approved list. Delimit separate file names and/or strings using a line break. Approved-lists support the \* wildcard.

Sample file:

```
[approved]
abcfile.doc
*.sc
```



## Setting the Scan Action for Viruses

After configuring the HTTP virus scanning rules, configure the actions that IWSVA takes if an infected file, uncleanable file, password-protected or macro-containing file is detected.

### Scan Actions

In **HTTP > Advanced Threat Protection > Policies | policy | Action** there are four actions that IWSVA can take in response to the outcome of virus scanning:

- Choose **Delete** to delete an infected file at the server. The requesting client will not receive the file. This action can be applied to the *Infected files*, *Uncleanable files*, and *Password-protected files* scan events.
- Choose **Quarantine** to move a file (without cleaning) to the quarantine directory.

`/var/iwss/quarantine`

The requesting client will not receive the file. This scan action can be applied to all four of the scan events. You can optionally choose to encrypt files before sending them to the quarantine directory. For more information, see [Quarantined File Handling starting on page 8-64](#).

- Choose **Clean** to have IWSVA automatically clean and process infected files. The requesting client receives the cleaned file if it is cleanable, otherwise the uncleanable action is taken. This action can be applied to the *Infected files* and *Macros* scan events. For macro-containing files, the Clean action strips the macro from the file, whether the macro is a virus or benign, to protect your network before an updated virus pattern is released and deployed.
- Choose **Pass** to send the file to the requesting user. This action can be applied to the *Uncleanable files*, *Password-protected files*, and *Macros* events. The Pass action should always be used for Macros events, unless you want to strip or quarantine all macro-containing files during a virus outbreak.

---

**Note:** Trend Micro does not recommend choosing the *Pass* scan action for uncleanable files.

---

## Scan Events

After scanning, you can configure actions for the four possible scanning outcomes:

- **Infected files**—Files determined to be infected with a virus or other malicious code. Available actions are **Delete**, **Quarantine** or **Clean** (recommended and default action).
- **Uncleanable files**—Depending on the type of virus or malicious code infecting a file, the scan engine might not be able to clean some files. Available actions are **Delete** (recommended and default action), **Quarantine**, and **Pass**.
- **Password-protected files**—Files that cannot be scanned because they are either password-protected or encrypted. The infection status of these types of files cannot be determined. Available actions are **Delete**, **Quarantine**, and **Pass** (recommended and default action).
- **Macros**—Microsoft Office files that contain macro program code. Because many of the fastest spreading viruses are macro viruses, you can quarantine all macro-containing files during the early stages of a virus outbreak to block all files before the new virus pattern is added to the pattern file and deployed to your environment. Available actions are **Quarantine**, **Clean**, and **Pass**. Unless there is a need to quarantine or strip macros during a virus outbreak before an updated pattern file is released, the action for Macro should always be set to **Pass**.

**Scan Policy: Add Policy** 

Policy List > (Test)  Enable policy

1. Select Accounts
2. Specify Web Reputation Rules
3. Specify Virus Scan Rules
4. Specify Spyware/Grayware Scan Rules
5. Specify Exception Lists
- 6. Specify Action**

File Type	Action
Infected files:	Clean
Uncleanable files: 	Delete
Password-protected files:	Pass
Macros:	Pass

**Note**

Note:

**FIGURE 8-16.** HTTP Virus Scanning Policy Action Configuration

## Adding Notes to Your Policy

To record notes about your policy, type them into the **Note** field at the bottom after configuring the actions taken against files detected by IWSVA. See **HTTP > Advanced Threat Protection > Policies | policy | Action**.

When you have completed configuring the scan actions to apply to your policy, click **Save**. Click **Deploy Policies** to immediately apply the policy; otherwise, the policy is applied after the database cache expires.

## Java Applet and ActiveX Security

IWSVA Applets and ActiveX scanning blocks malicious Java applets and unsecured ActiveX controls at the Internet gateway, preventing them from infiltrating your network and performing malicious acts on client workstations.

IWSVA employs a tiered technology approach that operates on both the Internet gateway server and on desktops.

- On the server, IWSVA prefilters Java applets and ActiveX controls based on whether they are digitally signed, the validity of the signature, and the status of the certificates used to do the signing.
- On client workstations, IWSVA code, inserted into Java applets, monitors the behavior of the applets in real time and determines whether their behavior is malicious according to a pre-configured security policy.

*Figure 8-17* illustrates how IWSVA scans and blocks malicious applets and ActiveX objects.

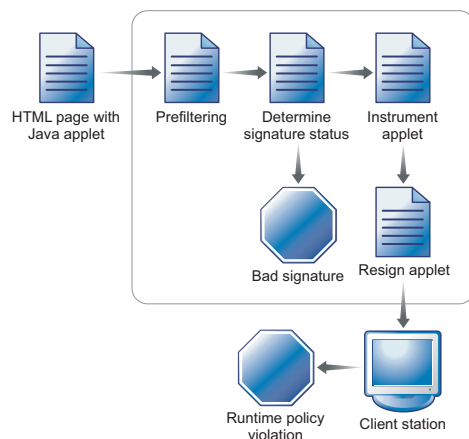

**FIGURE 8-17. How Java applet security works**

## How Applets and ActiveX Security Works

As applets and ActiveX objects pass through the gateway, the validity of their digital signatures are checked. In addition, IWSVA monitors applets in real-time on the client workstations and issues an alert if any prohibited operations are attempted.

### Step 1. Filtering Applets & ActiveX at the Server

As Java applets and ActiveX controls are downloaded to the proxy server, IWSVA filters them according to the following criteria:

### For ActiveX Objects

If ActiveX security is enabled, IWSVA checks the signatures of CAB files and executable COM objects (of which ActiveX controls are a type) that are digitally signed. It then examines the digital certificates contained in the signature and compares them with those in the IWSVA-specific certificate database. ActiveX objects not signed, invalidly signed, or signed using an unknown root Certification Authority (CA) certificate can be blocked. In their place, the system creates a new HTML page containing a warning message. This new page is then delivered to client workstations.

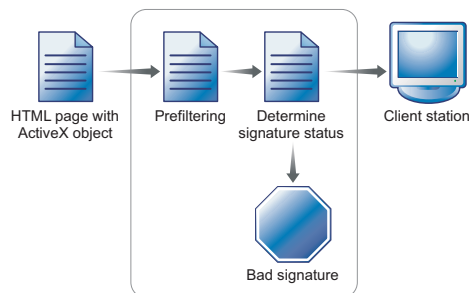

**FIGURE 8-18. How ActiveX Security Works**

### For Java Applets

IWSVA filters Java applets based on whether they are digitally signed, the validity of the signature, and the status of the certificates used to do the signing.

If signature verification is enabled, IWSVA verifies the signatures of digitally signed applets. Those not signed, signed using an unknown or inactive root Certification Authority (CA) certificate, signed using a flagged certificate, or invalidly signed can be blocked. They are then replaced with a new applet that displays a warning message. If certificate checking is disabled, the system accepts all Java applets regardless of the certificates they carry.

IWSVA keeps a database of recognized certificates, which is used in the filtering process. This database is automatically updated to include any unrecognized certificate the system encounters. You can delete entries from the database and enable or disable entries on the **HTTP > Applets and ActiveX > Settings** (see [Managing Digital Certificates starting on page 8-91](#)).

For Java Applets, IWSVA first performs Steps 2 and 3 below before sending the applets to the clients.

## Step 2. Instrumenting Applets

IWSVA analyzes the applet code to determine any potentially dangerous actions that it might perform. It then adds instrumentation code (that is, instructions that notify the user of certain programming operations) to monitor and control these actions.

During instrumentation, IWSVA inserts monitoring code around suspicious instructions and then attaches the security policy assigned to the intended recipients. Depending on how IWSVA is configured, this security policy might vary from one client to another, based on the domain they belong to or their IP addresses. IWSVA supports creating multiple policies that can be mapped to different groups of users in your network. IWSVA uses the inserted monitoring codes and the attached security policy to monitor the applet's behavior in real-time and to determine whether or not this behavior is malicious.

---

**Note:** The process of instrumenting a signed applet renders the signature invalid. Therefore, the signature is stripped, leaving it unsigned. IWSVA can optionally re-sign the applet if required by the client browser.

---

## Step 3. Optionally Re-signing Instrumented Applets

If configured to do so, IWSVA re-signs the instrumented applets using an imported “private key” before sending them to client workstations. Because applets lose their original signatures during the instrumentation process (due to modifications to their original code), you might want to use this feature to ensure that the clients' Web browsers run the instrumented applets with the permissions they might require to run correctly.

IWSVA supports the import of a “private key”, along with the associated certificate that contains the corresponding “public key,” for use in the re-signing process. You can purchase this key from any of the well-known Certifying Authorities (CAs). Only one re-signing key may be configured for use at any given time.

---

**Note:** Re-signing applies only to validly signed applets. If the system is configured to accept unsigned applets, these applets bypass this process and are delivered to client workstations immediately after instrumentation.

---

## Step 4. Monitoring Instrumented Applet Behavior

When the applet executes in the browser, the instrumentation is automatically invoked before any potentially dangerous operation is performed. The instrumentation determines whether an action is permitted by comparing it with the attached security policy. If the action is permitted, IWSVA then allows the action to take place; otherwise, IWSVA notifies the users and gives them the option to allow the behavior, terminate the behavior, or stop the applet.

## Enabling Applet/ActiveX Security

To start scanning your HTTP traffic for malicious applets and ActiveX objects, enable this scanning from the Applets and ActiveX policy page.

**To enable malicious Applets and ActiveX scanning in HTTP traffic:**

1. Select **HTTP > Applets and ActiveX > Policies** from the main menu.
2. Check **Enable Applet/ActiveX security**.
3. Click **Save**.

## Adding and Modifying Applet/ActiveX Scanning Policies

The first step when configuring a new policy is to set the client accounts to which the policy applies. See [Configuring the Scope of a Policy starting on page 7-17](#) for more information and procedures for setting a policy's scope using the three different user identification methods.

All configured policies are listed on the **Applets and ActiveX Policies** screen available from **HTTP > Applets and ActiveX > Policies**.

**To modify the scope of a policy:**

1. Open the **Applets and ActiveX Policy** screen (**HTTP > Applets and ActiveX > Policies** from the main menu).
2. Do one of the following:
  - To remove accounts from a policy's scope, select the users, click **Delete** and then **Save**.
  - To add accounts to a policy's scope, click the **Policy Name**, switch to the **Account** tab, add or delete the accounts to which the policy applies, and click **Save**.

Account fields should support IPv6 addresses. You can define one rule for any IPv6 host, and this policy rule is triggered when the client accesses Applets or ActiveX through IWSVA.

- When selecting available policies, both IPv4 and IPv6 policies will appear.
  - In the Account field, acceptable account entries include a single IPv6 address, an IPv6 range, or an IPv6 mask similar to what has been supported with IPv4.
3. Click **Deploy Policies**. Changes to a policy's scope do not take effect until the modified policies are deployed.

After configuring the scope of your policies, configure the applet and ActiveX scanning rules.

## Configuring Java Applet Security Rules

On the **HTTP > Applets and ActiveX > Policies** screen, add a new policy or select an existing policy. On the **Java Applets Security Rules** tab, IWSVA can be configured to either block all applets, or to accept and process applets using the security settings you specify.



## Signature Status

A digital signature is a way to verify the genuine publisher of an applet. It also allows you to verify that the applet has not been tampered with or otherwise changed because it was published. After analyzing the applet's signature, IWSVA makes one of the following determinations:

- **Valid signature**
- **No signature:** The applet is unsigned.
- **Invalid signature:** The applet's signature is corrupt or cannot be verified for some reason; for example, no trusted root certificate is found

Checking the signature of an applet is done in two steps. The first verifies the integrity of the applet code against data in the signature. The second verifies the integrity of the certificates, the “certificate chain,” used to create the signature. For the signature to be considered valid, the certificate chain must end with a trusted certificate recognized by IWSVA. The set of these certificates can be viewed and managed by opening the Web console to **HTTP > Configuration > Digital Certificates > Active Certificates**.

## Certificate Status

Java applet security rules can apply different actions to applets that have valid signatures, based on their certificate status.

By default, IWSVA trusts its active certificates. However, an active certificate can be “flagged” if you no longer want to trust applets that have a flagged certificate in their certificate chain. Flagged certificates continue to be listed as active certificates, though the flagged status is noted.

## Instrumentation and Re-signing

Instrumentation is the process through which IWSVA adds monitoring and control code to the applet. Because the instrumentation process breaks the applet's signature, if any, you can alternatively choose to re-sign an applet after instrumentation. This ensures the instrumented applets executes in the browser and perform operations as expected.

## Applet Instrumentation Settings

The purpose of instrumenting applets is to prevent applets from executing prohibited operations on client machines. By default, Java applets processed by IWSVA are not allowed to perform the following types of operations:

- **Destructive operations:** Deleting and renaming files
- **Non-destructive operations:** Listing files in a directory or retrieving file attribute information
- **Write:** Writing new or modifying existing files
- **Read:** Reading file contents

## Configuring Exceptions

For each of the types of operations that can be selectively allowed or prohibited, you can configure file or folder exceptions where the security policies do not apply.

- To allow a given type of file operation, except when performed by a subset of files, check the **Enable** button next to the file operation. Click the **Exceptions** link. The **Exceptions to File Operations** screen opens. Configure the files and folders where the operation is not allowed.
- To disallow a given type of file operation, except for a subset of files, check the **Disable** button next to the file operation. Click the **Exceptions** link and then configure the files and folders where the operation is allowed.

### To configure Java applet processing settings:

1. After setting the scope of your policy, do one of the following:
  - Select **Process Java applets using the following settings** for IWSVA to pass, block or instrument the applet based on its signature and certificate status.
  - Select **Block all Java applets** for IWSVA to not allow any applets to pass to the clients. If you choose this setting, proceed to step Step 3.
2. For each of the following signature and certificate status, choose the processing action to use (\* denotes the default Trend Micro-recommended settings):
  - **Valid signature, trusted certificate:** Pass\*, Instrument applet (re-sign), Instrument applet (strip signature), Block
  - **Valid signature, flagged certificate:** Pass, Instrument applet (re-sign), Instrument applet (strip signature), Block\*

- **No signature:** Pass, Instrument Applet\*, Block
  - **Invalid signature:** Pass, Instrument Applet (strip signature), Block\*
3. For each of the four (destructive, non-destructive, write or read) operations that can be selectively enabled or disabled, click **Enable** or **Disable** to configure your security policy.
  4. Click **Exceptions**, and then configure the files or folders that are exceptions to the security policy:
    - a. Enter the **Directory/File Path** of the files that do not apply to the configured security policy.
      - To configure a specific file path, select **Exact file path**.
      - To exclude the entire folder's contents from the security rule, select **Include all files in this directory**.
      - To exclude all of the folder's files, plus those in subdirectories, from the security rule, select **Include files in this and all subdirectories**.

---

**Note:** All file paths are those on the client machine, where the applet runs. The file path format should be in the form required by the operating system running on the client.

---

- b. Click **Add** to add the exceptions to the given security policy.
- c. Configure other files or directories to exempt from the applet's security settings.

- d. When you've completed configuring your file and folder exceptions, click **Save**.

**Exceptions to File Operations**

Destructive operations are enabled except for files in the following directory path

Directory/File Path:

Exact file path  
 Include all files in this directory  
 Include files in this and all sub-directories

Path	Directory/File	
temp	absolutely path	
test	all files	

**FIGURE 8-19. Java applet instrumentation settings exception files and folders**

5. On the **Java Applet Security Rules** tab, select **Bind local ports** to allow applets to bind to ports on the client workstation.
6. To allow applets to connect to their originating servers, select **Connect to their originating servers**.
7. To allow applets to connect to hosts other than the ones they originated from, select **Enable** or **Disable** next to **Host connections**, then configure exceptions to the security policy.
  - a. Enter the **Host** that does not apply to the configured security policy.
  - b. Click **Add** to add the exceptions to the given security policy.
  - c. Add others host that do not apply to the security policy.

- d. When you've completed configuring the hosts that are exceptions to the policy's security rules, click **Save**.

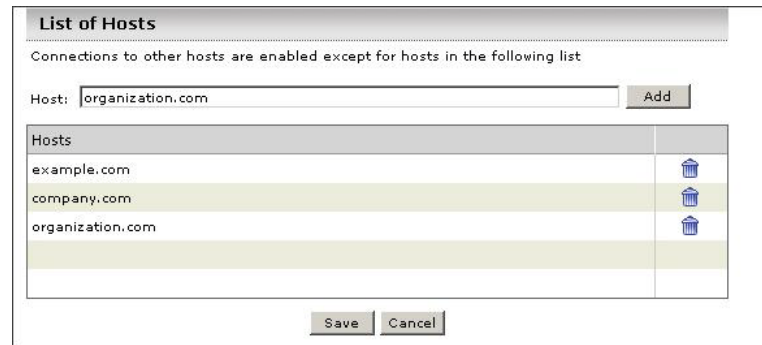

**FIGURE 8-20. Exceptions to the Java applet host connection rules**

8. Select **Create new thread groups** to allow applets to create new thread groups. To disallow this operation, clear it.
9. Select **Create unlimited active threads** to have IWSVA ignore thread activity from applets downloaded to clients on the LAN and specify a limit to restrict the number of threads applets can create at one time. To disallow this operation, clear it.
10. Select **Create unlimited active windows** to limit the number of active top-level windows applets can open. Enter the number of allowable windows in the provided text box. Clearing this option gives applets the freedom to open as many windows as they want—just like some malicious Java applets do to annoy users.
11. Enter any optional **Note** for future reference about this policy.
12. Click **Next** to continue with configure ActiveX security rules if you are configuring a new Applets and ActiveX policy. If you are modifying an existing policy, click **Save**.
13. Click **Deploy Policies** to immediately apply the policy; otherwise, the policy is applied after the database cache expires.
14. Enter any notes to save pertinent information about this policy, and then click **Save**.

## Configuring ActiveX Security Rules

ActiveX security rules can be applied to the two different types of ActiveX controls:

- **Executable cabinet files** (\*.cab): An ActiveX control distributed using the Windows native compressed archive format.
- **Portable executable (PE) files** (\*.exe, \*.ocx, and so on): An executable file format that has “portability” across all 32-bit and 64-bit versions of Windows.

For each of these two file types, you can configure security policies to:

- Block all ActiveX controls of that type
- Allow all ActiveX controls of that type
- Verify signatures, and alternatively block invalidly signed or unsigned files

Enter any notes about this policy and then click **Save**.

## Applying Applet and ActiveX Policy Exceptions

There may be URLs or Web sites that you want exempt from an Applet and ActiveX policy (for example, the corporate intranet, business partner sites, and research tool sites).

In the **Exceptions** tab, select the name of the approved URL list to be exempted from the **Approved URL List** field.

You can create exception lists in the **HTTP > Configuration > Approved Lists** page (see [Specifying the Exceptions List](#) on page 8-68 for more information).

## Applet and ActiveX Settings

Applet and ActiveX security policies determine certificate and signature status as configured on the **Applet and ActiveX Settings** page. For example, IWSVA can either attempt to validate signatures, strip the signatures and process all applets as being unsigned, or check the certificate's revocation status. In addition, IWSVA can re-sign applets after instrumentation.

To validate the signature of an ActiveX control, IWSVA can check the expiration of the signing certificate, check all certificates in the signing chain (exclusive of the signing certificate) and check the revocation status of the certificate (where a revocation information source is available for a certificate).

**To configure how IWSVA validates Java applet and ActiveX signatures:**

1. Click **HTTP > Applets and ActiveX > Settings** from the main menu.
2. Complete the settings on the **Java Applets** and **ActiveX Executables** tabs.
3. Click **Save**.

## Java Applet Signature Validation

When IWSVA processes signed applets, it can handle digital signatures in one of two ways:

- Strip signatures and treat all incoming applets as unsigned applets, a restrictive security setting that treats all applets, signed or unsigned, in the same manner. In a normal client browser environment, the unsigned applet does not have access to the client system's resources, but it can still produce annoying behavior such as opening many windows.
- Perform full signature validation on the applets.

## Adding Certificates for Applet Signature Verification

Java applet signatures are verified using root certificates installed. To see the list of root certificates, select **HTTP > Configuration > Digital Certificates** from the main menu. ActiveX signatures are verified against the root certificates in the IWSVA device's Windows certificate store.

If your environment requires running applets signed with root certificates that are not installed along with IWSVA, then add them to the IWSVA digital certificate store.

**To add a certificate to the IWSVA certificate store:**

1. Click **HTTP > Configuration > Digital Certificates** from the main menu.
2. On the **Active Certificates** tab, click **Add**, select the certificate, and then click **Add**.
3. Return to the **Active Certificates** screen and verify that the added certificate appears on the list.

## Certificate Expiration

IWSVA can be configured to:

- Check that the certificate used to sign the applet has not expired
- Check that the certificates in the certification path are all valid

## Untrusted Signature Status

If IWSVA is unable to determine whether the certificate should be trusted because of its certification path, then the applet's signature status can be set to:

- Unsigned (which means the signature is stripped), or
- Invalid

## Revocation Status

Digital certificates can be revoked by their issuer. IWSVA can check whether a certificate has been revoked when a status source is available.

If IWSVA cannot access the defined status source, you can configure IWSVA to set the status of the certificate to Valid, Unsigned (Strip signature), or Invalid.

## Applet Re-signing

IWSVA can re-sign instrumented applets with your company's own "private key" before they are sent to client workstations. Because applets lose their original certificates during instrumentation, you might want to re-sign them to ensure that clients' Web browsers always accept the applets without any restrictions.

To use the re-signing feature, you need two keys: 1) a "private key" that must be imported into IWSVA, and 2) a certificate containing the "public key" equivalent to your "private key" that must be imported into your clients' Web browsers. The certificate enables the browsers to recognize the signature you affix to instrumented applets. Without this certificate, these applets are treated as another unsigned applet—either blocked by the browser or given limited access to system resources.

IWSVA supports the PKCS12 key format. If you do not have a key yet, you can purchase one from any of the well-known Certificate Authorities (CAs).



**To re-sign applets after instrumentation:**

1. On the **Java Applets** tab of the **Applet and ActiveX Settings** page (**HTTP > Applets and ActiveX Settings**), check **Re-sign the applets with the following certificate**.
2. Type the path or click **Browse** to navigate to the certificate to use for re-signing.
3. Enter the certificate's **Password**.
4. Click **Add**.
5. Click **Save**.

## ActiveX Signature Validation

To verify whether an ActiveX control is validly signed, IWSVA can check the control's certificate in several ways—for both a Cab file and PE file. This validation includes checking the expiration of the signing certificate, the expiration of all certificates in the signing chain, or by checking the revocation status of the certificate (when a status source is defined).

**To configure how IWSVA checks the signature status of a signed ActiveX control:**

1. Select **HTTP > Applets and ActiveX > Settings** from the main menu, and click the **ActiveX Executables** tab.
2. Enable the types of signature checking to use for ActiveX controls:
  - Verify that the signing certificate has not expired
  - Check that all of the certificates in the certifying path have not expired
  - When the certificate's issuer is defined, verify whether the certificate has been revoked by the issuer
  - Signature timestamps can be checked. If set, a signature with an expired certificate is considered valid if it has a valid timestamp counter-signature.

If IWSVA is unable to access the certificate's issuer, then the status of the signature can be set to either **Valid** or **Invalid**.

3. Click **Save**.

## Client-side Applet Security Notifications

There are several alert messages that might be displayed in the client's browser in response to IWSVA Java applet security policies.

If an applet is blocked due to its signature or certificate status, the requesting client is presented with a message showing the policy that blocked the applet, along with the reason:

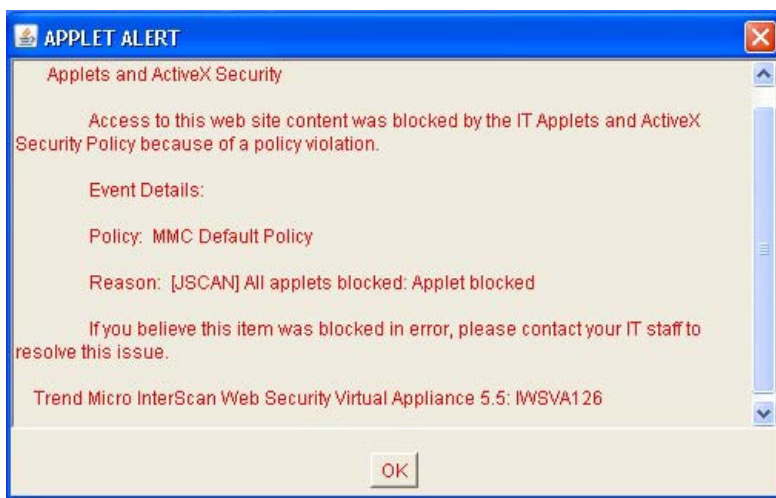
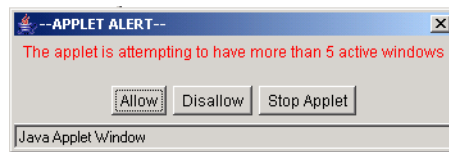

**FIGURE 8-21. Blocked applet notification**

If an instrumented applet attempts to perform an operation that is not allowed by a policy's configuration, a notification displays the disallowed operation and the user is prompted on how to proceed. Available options are:

- **Allow:** The instrumented applet continues to run, including the operations not allowed by the policy.
- **Disallow:** The operation that triggered the Applet security policy is stopped, but the instrumented applet continues to run.

- **Stop Applet:** The instrumented applet is terminated.



**FIGURE 8-22. Applet Security Violation Notification**

If the client chooses **Stop Applet**, another notification is displayed to indicate that the applet has terminated.

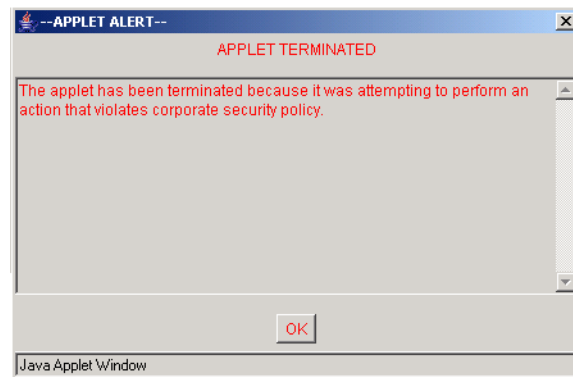

**FIGURE 8-23. Applet Execution Termination Notification**

## Managing Digital Certificates

For IWSVA to determine that a Web server's or an applet's signature is trusted, the root Certification Authority (CA) certificate on which the signature is based must be added to the IWSVA certificate store.

There are three types of digital certificates that are involved in producing a digital signature:

- The "end" or "signing" certificate, which contains the public key to be used to validate the actual applet signature

- One or more “intermediate” Certification Authority (CA) certificates, which contain the public keys to validate the signing certificate or another intermediate certificate in the chain
- The “root” CA certificate, which contains the public key used to validate the first intermediate CA certificate in the chain (or, rarely, the signing certificate directly). An otherwise valid signature is “trusted” by IWSVA if the CA certificate of the signature is known to IWSVA, is active, and is not flagged.

If IWSVA encounters an unknown certificate during SSL handshake or applet signature processing, it saves the certificate in the “inactive” list, along with the URL of the Web site or applet that contained the signature. All types of certificates are collected in this way (signing, intermediate, and root). If required later, a CA certificate collected this way can be “activated” (made trusted by IWSVA) so that the signatures of applets that depend on it can be processed as valid. Intermediate CA and end certificates might be activated, but this only has an effect if the root certificate is also activated. In other words, activating an intermediate CA or signing certificate does not make them trusted (only CA certificates can be made trusted), but any certificate might be flagged.

To manage the certificates in the IWSVA certificate store, you can perform the following operations:

- **Delete a certificate:** Removes the selected certificate(s) from the certificate store.
- **De-activate a certificate:** Keep the certificate in the IWSVA certificate store, but do not trust certificates that use it in their certification path.
- **Activate a certificate:** Make a CA certificate trusted.
- **Flag the certificate:** Flag all signatures that use the certificate in its certification path.
- **Clear flagged certificate:** Re-instate the trusted status of a certificate that was previously flagged, so that certificates that use the certificate in their certification path is trusted.

**To view existing certificates:**

1. Select **HTTP > Configuration > Digital Certificates** from the main menu.
2. Switch between the **Active Certificates** and **Inactive Certificates** tabs to see which certificates are already known to IWSVA.

**To add a trusted certificate:**

1. Select **HTTP > Configuration > Digital Certificates** from the main menu.
2. Ensure the **Active Certificates** tab is active.
3. Click **Add**.

The **Add Certificates** screen opens.

4. Type the path or click **Browse** to navigate to the certificate or certificates list exported from Internet Explorer you want to import to the Manage Digital Certificates list and then click **Add**.

---

**Note:** Certificates are commonly contained in files with the extensions .cer, .der, .crt. Also, only active CA certificates are considered trusted, but any active certificate might be flagged.

---

The screen returns to the **Active Certificates** tab. The certificate that you added should be visible, along with the type of certificate and its expiration date.

**To delete a certificate:**

1. Select **HTTP > Configuration > Digital Certificates** from the main menu.
2. Select the certificate(s) to delete.
3. Click **Delete**.

**To de-activate a trusted certificate:**

1. Select **HTTP > Configuration > Digital Certificates** from the main menu.
2. Make sure the **Active Certificates** tab is active.
3. Check the certificate(s) to de-activate.
4. Click **De-activate**.
5. The certificate(s) that you selected moves to the **Inactive Certificates** tab.

**To activate a certificate:**

1. Select **HTTP > Configuration > Digital Certificates** from the main menu.
2. Make sure the **Inactive Certificates** tab is active.
3. Select the certificate(s) to activate.
4. Click **Activate**.
5. The certificate(s) that you selected moves to the **Active Certificates** tab.

**To flag a certificate:**

1. Select **HTTP > Configuration > Digital Certificates** from the main menu.
2. Make sure the **Active Certificates** tab is active.
3. Select the certificate(s) to flag.
4. Click **Flag Certificate**.
5. The flagged certificate(s) remains visible on the **Active Certificates** tab, with a red flag in the status column.

**To remove a certificate from being flagged:**

1. Select **HTTP > Configuration > Digital Certificates** from the main menu.
2. Make sure the **Active Certificates** tab is active.
3. Select the flagged certificate(s) to be cleared (certificates with flagged status have a red flag in the **Status** column).
4. Click **Clear Flagged Certificate**.
5. The flagged certificate(s) remains visible on the **Active Certificates** tab, without a red flag in the **Status** column.

# Chapter 9

## Access Quotas and URL Access Control

Access quotas limit a client's bandwidth consumption to a fixed amount per unit of time. URL trusting can improve browsing performance by exempting trusted URLs from scanning and other InterScan Web Security Virtual Appliance (IWSVA) operations. URL blocking refuses requests to URLs that you specify or whose patterns are contained in the Phish pattern file.

Topics in this chapter include:

- [Introduction to Access Quota Policies on page 9-2](#)
- [Overview of URL Access Control on page 9-4](#)
- [Specifying URL Access Control on page 9-5](#)

## Introduction to Access Quota Policies

The InterScan Web Security Virtual Appliance includes a policy for other clients that can be defined (there is no access quota Global Policy). If no policy matches the connection, then the client has unlimited access. After modifying access quota policies and saving the policies to the database, the InterScan Web Security Virtual Appliance service in a multiple server configuration environment reloads the policies according to the time-to-live (TTL) value configured in the **Policy Deployment Settings** screen (**Administration > IWSVA Configuration > Policy Deployment**.)

If the quota is exceeded while making a download, the download is allowed to continue. However, succeeding downloads/browsing requests (before the access quota interval expires) are refused. Users are allowed access again after the access quota interval expires.

---

**Note:** For a group quota policy, the quota is for each client within the policy's scope, and all clients in the same policy have the same quota.

---

## Managing Access Quota Policies

The clients within the scope of an access quota policy, the bandwidth quota and the time interval for the quota's duration are configurable. Access Quota Policies can also be applied to IPv6 clients as with the IPv4 clients. Account fields should support IPv6 addresses. You can define one rule for any IPv6 host, and this policy rule is triggered when the client accesses the Internet through IWSVA.

When selecting available policies, both IPv4 and IPv6 policies will appear. In the Account field, acceptable account entries include a single IPv6 address, an IPv6 range, or an IPv6 network mask similar to what has been supported with IPv4.

### To add an access quota policy:

1. Click **HTTP > Access Quota Policies** from the main menu.
2. Select **Enable access quota control**.
3. From the drop-down menu, select the access quota interval—either **Daily**, **Weekly**, or **Monthly**.

The value for the access quota interval is globally applied to all access quota policies, including all existing policies.



4. Click **Save**.
5. Click **Add**.
6. Select **Enable policy** and enter the access quota.
7. Select the users to which the policy applies.

The options on this page depend upon the user identification method that you are using—either *IP address*, *Host name (modified HTTP headers)*, or *User/group name authentication*. These settings are configured in the **Administration > IWSVA Configuration > User Identification | User Identification** tab. For more information about configuring the user identification method and defining the scope of a policy, see [Configuring the User Identification Method starting on page 7-6](#).

Regardless of the user identification method you have configured, you can always enter IP addresses of the clients to which the policy applies.

8. Type some optional notes to record any special information about the policy.
9. Click **Save**.
10. When returned to the **Access Quota Policies** page, click **Deploy Policies** to immediately apply the policy; otherwise, the policy is applied after the database cache expires.

There might be occasions when you want to temporarily deactivate a policy, without deleting the settings from the database.

**To deactivate a policy:**

1. Click **HTTP > Access Quota Policies** from the main menu.
2. From the **Access Quota Policies** screen, click the linked item in either the **Account** or **Access quota** column to go to the Edit Policy screen.
3. Clear **Enable policy** at the top of the screen and then click **Save**.

Disabling the policy does not take effect until the policy cache refreshes, or you click **Deploy Policies**.

If you no longer have any need for a policy (for example, if the employee using the client leaves your organization), you can either delete the whole policy or users within the policy's scope from the InterScan Web Security Virtual Appliance database.

**To delete a policy:**

1. Click **HTTP > Access Quota Policies** from the main menu.
2. From the **Access Quota Policies** screen, select the policy and then click **Delete**.  
Deleting the policy does not take effect until the policy cache refreshes, or you click **Deploy Policies**.

## Overview of URL Access Control

IWSVA can control a URL's access based on Web Reputation feedback, the URL Filtering module, or a combination of both. The combination of Web Reputation and the URL Filtering module is a multi-layered, multi-threat protection solution provided by IWSVA.

The URL Filtering module grants or denies Web access based on the category to which a URL belongs. Web Reputation grants or denies Web access based on whether the requested URL is a phishing or pharming threat that has hacking potential, or has a reputation score that deems it untrustworthy. Both the URL Filtering module and Web Reputation are controlled by the specifications you make in policies. See **HTTP > URL Access Control**

When a user attempts to access a Web site, the following events occur:

- IWSVA checks the requested URL against the URL blocking list and trusted URL list (see [Overview of URL Access Control on page 9-4](#)).  
If the URL is found on the URL blocking list, the request is denied. If the URL is found on the URL trusted list, access is granted and no form of access control is done.
- If the URL is not on the blocked or trusted list, IWSVA sends the requested URL to Web Reputation for processing.
- From a remote database, Web Reputation retrieves the appropriate URL rating for the URL.

The rating can either be “high,” “medium,” or “low.” The sensitivity level you specify determines whether or not IWSVA blocks the URL (see [Specifying Web Reputation Rules on page 8-42](#)).

If the URL is found on an approved list, IWSVA skips the anti-phishing and anti-pharming detection for this URL (see [Specifying the Exceptions List on page 8-68](#)).

- Web Reputation then determines if the requested URL is a phishing or pharming threat and if so, flags the URL accordingly (see [Anti-phishing, Anti-pharming, and C&C Callback Attempt Detection on page 8-43](#)).
- The final process of Web Reputation is to determine the category of the URL (see [URL Filtering Category Mapping on page G-1](#)).

The category information is used later by the URL Filtering module.

- Web Reputation returns the URL rating to IWSVA, any phishing or pharming flags, and the URL category.
- If a URL is flagged for phishing or pharming, IWSVA blocks access to the Web site.
- Next, if you are using the URL Filtering module, this module uses the Web category information for the requested URL to determine if access is permissible.

If the URL is found on the approved URL list, the URL bypasses the category filtering and proceeds to the final step in URL access control (see [Scheduled Time Settings on page 10-12](#)).

If the category of the requested URL is permitted in the URL Filtering policy, then the URL is passed on to the final step; otherwise, the URL is blocked.

- Finally, based on the Web Reputation URL rating, IWSVA determines whether the requested URL is below or above the sensitivity level specified in the scan policy.

If the URL is found on an approved list, IWSVA skips the sensitivity level checking for this URL (see [Specifying the Exceptions List on page 8-68](#)).

If the rating falls below the sensitivity level, the requested URL is blocked. However, if the rating is above the sensitivity level, IWSVA grants access.

## Specifying URL Access Control

InterScan Web Security Virtual Appliance can optionally “trust” some URLs and exempt them from scanning and filtering to improve browsing performance to low risk sites. It can also block access to sites using a user-configured list, or by checking requested sites against the Phish pattern file, a compilation of sites associated with “phishing” schemes or other malicious acts.

## Configuring Trusted URLs

InterScan Web Security Virtual Appliance can be configured to trust some URLs and exempt them from scanning and filtering. Because this opens a security risk by allowing unchecked content into your network, configuring a URL as “trusted” must be considered carefully. Because trusted URLs are not scanned, browsing performance is improved. Good candidates for trusting are Web sites that are frequently accessed and contain content you can control (for example, your company’s intranet sites).

Trusted URL information is kept in the `[URL-trusting]`, `normalLists` section of the `intscan.ini` configuration file.

When configuring trusted URLs, you can specify the sites using the following:

- The Web site, which includes any sub-sites
- Exact-match strings within a requested URL

You can apply exceptions to sites that would otherwise match the criteria for the trusted URL list, so InterScan Web Security Virtual Appliance scans or filters them as usual.

A list of trusted URLs and their exceptions can also be imported from a file, in addition to configuring them through the user interface. Write a comment or title (which InterScan Web Security Virtual Appliance ignores) at the top of a file that contains a list of Web sites, URL keywords, or strings, and then write one rule per line. Group sites to be blocked under `[block]` as shown in the following example, and group exceptions under `[allow]`:

```
URL Blocking Import File {this title is ignored}

[block]
www.blockedsite.com*
unwanted.com*
urlkeyword
banned.com/file
banned.com/downloads/

[allow]
www.blockedsite.com/file
www.unwanted.com/subsite/
www.trendmicro.com*
```

---

**Note:** For HTTPS decryption policies, the strings to match vary depending on whether you set IWSVA in proxy or transparency mode.

- In proxy mode, IWSVA matches the domain names, not the full URL. Thus, you only need to specify the domain names.
- In transparency mode (WCCP or bridge mode), IWSVA matches the CommonNames in the server certificates received.

---

**Managing your trusted URLs and exceptions:**

1. Click **HTTP > URL Access Control > Global Trusted URLs** from the main menu.
2. In the **Trusted URLs** configuration page, select **Enable Trusted URLs** to enable URL trusting.

---

**WARNING!** When you select the “Enable Trusted URLs” option, the content of trusted URLs will not be filtered and scanned for viruses.

---

3. Select how you want to specify the URL to trust:
  - **Web site** match (including all sub-sites)
  - **String** match (URL must contain the string)
4. Type the URL string to **Match** and click **Trust** to add it to the Trusted URLs list (shown below the “**Do Not Scan these URLs**” section). To configure exceptions to the trusted URLs list, click **Do Not Trust** and your entry is entered under **Exceptions to the Trusted URL List**.
5. To remove a trusted URL or exception from your trusted URLs list, highlight the item and click **Remove**. **Remove All** clears all the items.
6. Click **Save**.

**To import a list of trusted URLs and their exceptions:**

1. Click **HTTP > URL Access Control > Global Trusted URLs**.
2. Browse or type the name of the file that contains the list of trusted URLs and their exceptions into the “**Import Trusted list and exceptions**” field.
3. Click **Import**. The trusted URLs and their exceptions from the file appear in the appropriate fields on the interface.
4. Click **Save**.

## Blocking URLs

InterScan Web Security Virtual Appliance can block Web sites and URL strings in the global blocked URL list.

---

**Note:** If you have installed the ICAP proxy handler, configure the ICAP client to scan files in pre-cache request mode to make this feature work.

Depending on the deployment mode, you can block an HTTPS Web site by entering the FQDN (in standalone/dependent mode) or certificate cn information (in bridge or WCCP mode).

---

When configuring URLs to block, you can specify the sites using the following:

- The Web site, which includes any sub-sites
- Keyword matching within a URL
- Exact-match strings within a requested URL

You can apply exceptions to the blocked URL list so InterScan Web Security Virtual Appliance allows requests as usual. Using this feature, you can block a given site to allow access to some of its sub-sites or files. The URL Blocking list (including exceptions) is maintained in the `/etc/iscan/URLB.ini` file. The path for the `URLB.ini` file is set using the “normalLists” parameter under the [URL-blocking] section in the `intscan.ini` file.

You can also block URLs based on pattern matching with the Phish pattern file (`/etc/iscan/URLB.ini`), a database of patterns of Web sites associated with phishing or related schemes.

In addition to adding the URLs through the Web console, URL block lists can be imported from a text file.

## Using a Local List

You can configure InterScan Web Security Virtual Appliance to block access to URLs based on a list of blocked sites and exceptions that you maintain for your environment.

When adding URLs to the **Block List** and “**Exceptions to the Block List**,” it is best that you first make all additions to one list and then save this configuration before you make additions to the other list. This method helps ensure that the same URL exists in

both lists. If you attempt to add a URL to the **Block List** or **Exceptions to the Block List** and it already exists in the other list, InterScan Web Security Virtual Appliance prevents the addition and displays a warning message stating that the entry already exists in the other list.

**To configure URLs to block:**

1. Click **HTTP > URL Access Control > Global URL Blocking**.
2. Select “**Enable URL blocking**.”
3. On the **URL Blocking** page, type the full Web address or URL keyword, or exact-match string in the **Match** field.

To identify a folder or directory in a given Web site, use a forward slash (/) after the last character. For example, if you want to block `www.blockedsite.com` but allow access to its `charity` directory:

- a. Type `www.blockedsite.com` in the **Match** field, then click **Block**.
- b. Type `www.blockedsite.com/charity/` in the **Match** field, and click **Do Not Block**. (If you write `charity` without the forward slash, IWSVA considers `www.blockedsite.com/charity` as a file.)

---

**Note:** For HTTPS decryption policies, the strings to match vary depending on whether you set IWSVA in proxy or transparency mode.

- In proxy mode, IWSVA matches the domain names, not the full URL. Thus, you only need to specify the domain names.
- In transparency mode (WCCP or bridge mode), IWSVA matches both the CommonNames and URLs. You must include these in the blocking list if you want to block an HTTPS site.

---

4. Click **Remove** to remove the highlighted entries from the list (or **Remove All** to remove all entries).
5. Click **Save**.

## Importing a List of Blocked URLs from a File

InterScan Web Security Virtual Appliance can import a list of URLs to block from a file. Type a descriptive title or comment on the first line of a file that contains a list of Web sites, URL keywords, or strings, and then write one rule per line. Group sites to be blocked under [block] as shown in the example, and group exceptions under [allow]. For example:

```
URL Blocking Import File {this title will be ignored}

[block]
www.blockedsite.com*
unwanted.com*
urlkeyword
banned.com/file
banned.com/downloads/

[allow]
www.blockedsite.com/file
www.unwanted.com/subsite/
www.trendmicro.com*
```

To include the “\*” and “?” characters in a URL blocking string rather than having IWSVA consider them as wildcards, use variable %2a or %2A to represent \* and variable %3f or %3F to represent ?. For example, to block `www.example.com/*wildcard` literally, specify the blocking rule as `www.example.com/%2awildcard` instead of `www.example.com/*wildcard`.

If importing the list is not successful, verify that you have followed the specified format for the URL Blocking import file before contacting customer support. Be sure you have:

- Listed blocked entries under [block] and exceptions under [allow]
- Formatted entries containing wildcards described in this document or Online Help

### To import a list of URLs to block:

1. Format a text file as described with the URLs to block, along with any exceptions.
2. Click **HTTP > URL Access Control > Global URL Blocking** on the main menu.
3. Specify the location of the file to import in the “**Import block list and exceptions**” field by clicking **Browse**, and clicking **Import**.
4. Click **Save**.



# Chapter 10

## URL Filtering

This chapter presents an overview and workflow of the InterScan Web Security Virtual Appliance (IWSVA) URL filtering module with procedures for creating and configuring URL filtering policies.

URL filtering, along with Web Reputation, is part of the multi-layered, multi-threat protection solution provided by IWSVA (see [Overview of URL Access Control on page 9-4](#)).

Topics in this chapter include the following:

- [Introducing URL Filtering on page 10-2](#)
- [Managing URL Filtering Policies on page 10-5](#)
- [URL Filtering Settings on page 10-9](#)
- [URL Filtering Time Quota Extension on page 10-14](#)

## Introducing URL Filtering

The default settings for the IWSVA URL filtering module assume that your organization's primary interest is to avoid legal liabilities associated with viewing of offensive material and/or prevent employee abuse of non-business websites. However, because there are instances that require exceptions, additional policies can be created to allow access to restricted category groups for employees whose job functions require broader access. For example, members of the Human Resources or IT departments might need unrestricted Internet access to conduct investigations into violations of your organization's acceptable Internet use policies.

IWSVA supports the Safe Search feature provided by search engine filtering providers (such as Google and Yahoo). Safe Search is used to filter adult sites and content from the search results and helps protect children from exposure to adult material.

In addition, IWSVA provides enhanced filtering by combining dynamic filtering with the advanced Web Reputation databases. Browsing Web sites related to online trading, shopping, auction bidding, dating, gambling, and other non-work related activities during work time reduces employee productivity and decreases bandwidth available for legitimate browsing. IWSVA allows Internet access to be customized according to user and workgroup-specific needs, thus optimizing the use of the Internet.

See **HTTP > URL Filtering > Policies | policy | Rule** tab.

IWSVA's URL filtering policies provide a granular and flexible mechanism to manage Internet access. Each policy has three basic elements that include the following:

- IWSVA access to the Web Reputation database that contains URLs in over 82 categories, such as “gambling,” “games,” and “personals/dating.” Categories are contained in the following logical groups:
  - Custom Categories
  - Network Bandwidth
  - Internet Security
  - Communications and Search
  - Adult
  - Business
  - Lifestyle
  - General

- Access to Web sites in each category can be allowed, blocked, or monitored during time periods designated as scheduled time object.
- Different policies can be configured for different users in your environment.

Access to all identified URLs within a targeted category might be managed according to policy. The database associates each URL with one or more categories. To accurately define a Web site, the URL may belong to multiple URL categories. For example, a shopping site that contains malware may belong to the Shopping category as well as the Virus Accomplice category. Depending on how many URL categories the URL falls into, the URL filtering policy may manage the access differently. If a URL that your organization needs to access is associated with a prohibited category, you can create exceptions to URL filtering rules to override the database's classification. The patterns specified in the Approved URL List are matched against the URL, not to the content of the document to which the URL refers. IWSVA gives you the option of configuring a URL filtering approved-list by matching Web site, URL keyword, and exact-string categories.

Another way to bypass IWSVA's default URL categorization is to create Custom Categories and assign the necessary access privileges to allow user access.

## URL Filtering Actions

The following are the filtering actions that you can apply for a given policy with a scheduled time object:

- **Allow**—Connection to the target server is allowed and users can access the Web site.
- **Block**—Connection to the target server is not established and users are not allowed to access the Web site. A log entry is also created for this event.
- **Block with Override**—Connection to target service is not established unless the user can type a specific password to override the category blocking.

---

**Note:** Applying the “block with override” action to categories in a policy requires administrators to enter the password used for overriding when creating the policy. Enter this password in the “Password Override Settings” section below the list of categories.

---

- **Monitor**—Connection to the target server is allowed and users can access the Web site. A log entry is also created for this event.
- **Time Limit**—Connection to the target server which accesses selected categories of URLs is allowed for the period of time configured by the administrator.

---

**Note:** 1. Selecting the “Time Limit” action for categories requires administrators to enter a value in “Time quota” text box in the Time Limit Settings section under the list of categories.

2. The default quota unit is five minutes. Trend Micro recommends that administrators set the “Time quota” value to a multiple of five. Otherwise, IWSVA ignores the remainder less than five. For example, if the value is set to 4 minutes, IWSVA interprets that as 0 minutes. If the value is set to 9 minutes, system interprets that as 5 minutes.

---

- **Warn**—Connection to the target server is allowed but a notification displays, warning users that the URL about to be accessed belongs to a category that violates company policy. Users have the option of continuing to the page or going back to the previous page.

## URL Filtering Workflow

The input for URL filtering consists of the URL and the user's ID (IP address, IP address range, user name, group name, or host name). A user is identified according to the user identification method that IWSVA is configured to use (see [Configuring the User Identification Method starting on page 7-6](#)).

A URL requested by a user can be classified into one or more of 82-plus categories, which are organized into 7 pre-defined groups. IWSVA passes the requested URL through IWSVA's URL filtering engine to be filtered according to their policies for the user making the request. Based on the category to which the requested URL belongs and the policy's action, the URL can be allowed, blocked, monitored or issued a warning.

---

**Note:** Manual updates to the URL filtering engine can be done from the **Manual Update** screen.

---

## Managing URL Filtering Policies

IWSVA is pre-configured with two default URL filtering policies—the Global Policy that applies to all clients on the network, and the Guest Policy that applies to clients that access IWSVA with a guest account.

---

**Note:** The Guest Policy is only supported if you have configured IWSVA using Captive Portal as Authentication Method.

---

## Enabling URL Filtering

Make sure that the URL filtering module is enabled before you start. The Account fields support IPv6 addresses. You can define one rule for any IPv6 host, and this policy rule is triggered when the client accesses Web sites through IWSVA.

When selecting policies, both IPv4 and IPv6 policies will appear. In the Account field, acceptable account entries include a single IPv6 address, an IPv6 range, or an IPv6 mask similar to what has been supported with IPv4.

IWSVA supports the “URL Warn mode” feature with IPv6, and can automatically redirect the warning message to IWSVA’s IPv6 or IPv4 addresses to the client based on the version of the client’s IP address.

- When a client uses an IPv4 address, IWSVA sends a redirect request with IWSVA’s IPv4 address.
- When a client uses an IPv6 address, IWSVA sends a redirect request with IWSVA’s IPv6 address.

### To enable URL filtering:

1. Click **HTTP > URL Filtering > Policies** from the main menu.
2. Select **Enable URL filtering**.
3. Click **Save**.

## Creating a New Policy

Creating a new URL filtering policy is a four-step process:

- Select the accounts to which the policy applies.
- Specify the Web site categories to be allowed, blocked, monitored or warned during the time defined in scheduled time object.
- Select the Safe Search mode
- Select an exception list

### To create a new policy:

1. Open the IWSVA Web console and click **HTTP > URL Filtering > Policies** from the main menu.
2. Click **Add**.

The **URL Filtering Policy: Add Policy** screen appears.

3. Type a descriptive **Policy name**.

Policy names that include references to the users or groups to which they apply, for example, “URL Filtering Policy for Researchers,” are easy to remember.

4. Select the users to which the policy applies.

The options on this page depend upon the user identification method that you are using—either *IP address*, *Host name (modified HTTP headers)*, or *User/group name authentication*. For more information about configuring the user identification method and defining the scope of a policy, see [Configuring the User Identification Method starting on page 7-6](#).

5. Click **Next**.
6. On the **Specify Rules** screen, ensure that **Enable policy** is selected.
7. Select one of the following filtering actions for each URL category or sub category:
  - **Allow**—Connection to the target server is allowed and users can access the Web site.
  - **Block**—Connection to the target server is not established and users are not allowed to access the Web site. A log entry is also created for this event.
  - **Block with Override**—Connection to target service is not established unless the user can type a specific password to override the category blocking.
  - **Monitor**—Connection to the target server is allowed and users can access the Web site.

- **Time Limit**—Connection to the target server which accesses selected categories of URLs is allowed for the period of time configured by the administrator.
  - **Warn**—Connection to the target server is allowed but a notification displays, warning users that the URL about to be accessed belongs to a category that violates company policy. Users have the option of continuing to the page or going back to the previous page.
8. Select to apply the filtering action during the time defined in scheduled time object.
    - **Action During/Scheduled Times**—Select the filtering action to apply and then set the schedule. To select all the categories of a group, click the check box for the group. The group does not need to be expanded for you to select all categories in a group. Restricted days and hours are defined in the URL Filtering Settings (Schedule tab) page. For more information, see [Scheduled Time Settings on page 10-12](#).
  9. Click **Apply** to apply the filtering action to the selected categories.

---

**Note:** Repeat steps 8 and 9 if you want to apply a different filtering action to sub-categories in the same group.

---

10. (Optional) In the **Password Override Settings** section, you must enter the password used for the overriding the blocking action. This is only necessary if you configure a policy to use the “Block with Override” action setting for a URL Filtering category.

---

**Note:** Passwords are policy-specific.

---

11. Type an optional **Note** to include useful information about this policy for future reference.
12. Click **Next**.

13. Select a Safe Search setting for each search engine and click **Next**.
  - **Strict**—Filters out adult contents from all search results (including image, video, and Web search).
  - **Moderate**—Filters out adult contents from Web search results only (excluding image search).
  - **Off**—Does not filter search results. This is the default setting.
14. In the **Specify Exception Lists** screen, select an approved URL list name from the drop-down list box if you want to apply an exception list. URLs in the exception list will bypass URL filtering.
15. Click **Save**.
16. In the **URL Filtering Policies** screen, set the priority of the new policy (under the **Priority** column) by clicking on the up or down arrows.

The **Priority** setting determines which policy is applied if there are accounts belonging to two or more policies. For accounts that belong to more than one policy, IWSVA will execute the policy on a first match bases. Policies that contain the account after the first match policy is executed are skipped.
17. Click **Save**.
18. To immediately apply the policy, click **Deploy Policies Now**; otherwise, the policy is applied after the database cache expires.

## Modifying and Deleting Policies

IWSVA gives you the option of editing any existing policy to better suit your current environment. You can also delete unnecessary account(s) from a policy.

### To modify an existing policy:

1. Click **HTTP > URL Filtering > Policies** from the main menu.
2. Click the **Account Name** or **Policy Name** links of the policy to be modified.
3. The **URL Filtering Policy: Edit Policy** screen opens.
  - Change the scope of your policy by adding or deleting clients on the **Account** tab.
  - From the **Rule** tab, modify filtering action for the URL categories.



- From the **Safe Search Engine** tab, change the Safe Search mode for each search engine.
  - From the **Exception** tab, select an exception list that you want to apply to this policy.
4. Click **Save**.
  5. Go to **HTTP > URL Filtering > Policies** and set the priority of your policies using the arrows. The **Priority** setting determines which policy is applied if there are accounts belonging to two or more policies.
  6. Click **Save**.
  7. Click **Deploy Policies** to immediately apply the policy; otherwise, the policy is applied after the database cache expires.

## URL Filtering Settings

There are several settings related to URL filtering that you can modify to reflect the realities of your work environment:

- Over 82 predefined Web site categories, organized in seven (7) logical groups
- Configuring your own custom categories
- Select the time object defined in “Scheduled Times.”

Additionally, if you believe a URL is classified in the wrong category, you can send a request to Trend Micro to consider re-classifying the URL. You can also look up the category of a URL that you are not sure of.

## Creating Custom Categories

You can define new URL categories in addition to the categories already provided by Trend Micro. For example, you can create a category called “Competitor's Web site” that contains the URLs of your company's competitors.

The **HTTP > Configuration > Custom Categories** screen displays a list of user-defined categories. Click **Add** to create a new one or click a category name to edit an existing one.

- **Category Name**—Type a brief but descriptive name for the custom category. Names must be unique.
- **Match**—Enter a Web site, a keyword or phrase, or a string of characters in the field, and then tell IWSVA how to apply the match. This field supports both the ? and \* wildcards. Entries in this field are added one-by-one to the custom category.

---

**Note:** For HTTPS decryption policies, the strings to match vary depending on whether you set IWSVA in proxy or transparency mode.

- In proxy mode, IWSVA matches the domain names, not the full URL. Thus, you only need to specify the domain names.
- In transparency mode (WCCP and Bridge mode), IWSVA matches the CommonNames in the server certificates received.

---

- **Web site**—Limits the search to the string as a whole; used with one or more wildcards, this type of setting can be especially useful for applying the configured URL filtering action to an entire Web site. There is no need to include http:// or https:// in the URL (it is automatically stripped).
- **URL keyword**—Looks for any occurrence of the letters and/or numbers within a URL, and will match regardless of where the string is found (the string “sex” would be considered a match for “http://www.encyclopedia/content/sextion.htm” and the page blocked). Using wildcards in this field greatly increases the chance of false positives and unexpected results.
- **String**—Limits the search to the string as a whole, for example to target a specific site, page, file, or other particular item.
- **Import Custom Category List**—You can import an existing list of URLs that you want to add to a category. For example if you have a list of your competitors’ URLs you have compiled using a text editor, you can import the list rather than enter them one-by-one. Imported lists must conform to a defined standard (refer to the Online Help for more information).

## Requesting URL Reclassification and URL Lookup

Organized in seven logical groups, IWSVA includes default categories that provide a baseline level of URL filtering. For example, Web sites related to humor and jokes would be found in the “Joke Programs” category, which is located in the *Network Bandwidth* group.

If you do not agree with the default classification of a URL, Trend Micro enables you submit a request for a reclassification. You can also use the Exception List or Custom Categories to bypass domain and Web site ratings categorized by Trend Micro’s URL filtering database.

Before rolling out URL filtering policies, Trend Micro recommends verifying that the default categorizations are appropriate for your organization. For example, a clothing retailer might need to remove a swimsuit Web site from the “Intimate Apparel/Swimsuit” category located in the *Adult* group in order to allow legitimate market and competitor research.

If you want to know a category of a URL, you can look it up when specifying URL filtering settings in the **HTTP > URL Filtering > Settings | URL Reclassification & Lookup** tab.

## Unrated and Unknown URLs

An *unrated* URL is a Web site that Trend Micro knows about but has not yet put into a filtering category.

An *unknown* URL is a Web site that is one of the following:

- Unknown to Trend Micro
- A Web site that is not in the Web Reputation database
- The daemon might be down or the remote rating server is inaccessible to give the URL a rating

An unknown URL has a rating of zero (0) and cannot be blocked.

## Requesting a Reclassification

**To request a URL reclassification:**

1. Click **HTTP > URL Filtering > Settings** from the main menu.
2. Click the **URL Reclassification & Lookup** tab.

3. Click on the link to the [Trend Micro Site Safety Center](#).  
The Trend Micro Online URL Query - Feedback System screen appears.
4. Enter the suspect URL in the field and click **Check Now**.

*Figure 10-1* shows the results from an approved URL.

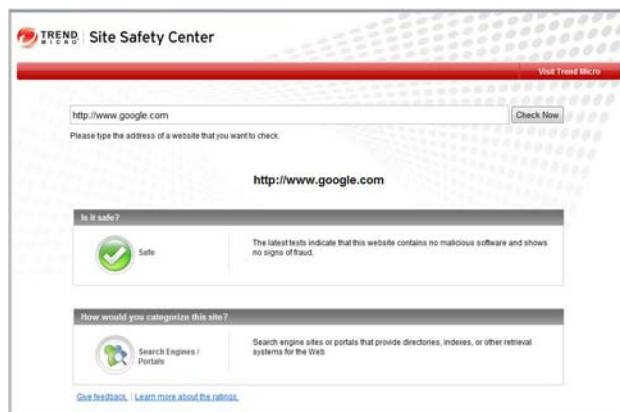

**FIGURE 10-1. Trend Micro Online URL Query - Site Safety Center screen**

5. To suggest a change, click **Give Feedback** and type the necessary information.

## Scheduled Time Settings

IWSVA enables you to specify the settings of the days and hours you want to set for different actions.

When creating URL filtering policies, set a policy to take effect for work time 1 and work time 2.

IWSVA policies permit or block access to URL categories during these work times. By default, IWSVA uses the following default work time settings:

- Work days: Monday to Friday
- Work hours: 8:00 to 12:00 (Work Time 1) and 13:00 to 17:00 (Work Time 2).

---

**Note:** It is assumed that all IWSVA devices in a cluster are within the same time zone.

---

Before implementing URL filtering policies in your organization, Trend Micro recommends creating a new time object for your time schedule.

**To configure the URL filtering policy schedule:**

1. Open the IWSVA Web console and click **Administration > IWSVA Configuration > Scheduled Times**.
2. Input the time object name and description. Select the time period in which you would like to apply the action.
3. Click **Save**.

## URL Access Warning TTL

The URL Access Warning Time-to-Live (TTL) setting allows the administrator to configure the amount of time between displayed warning messages, if the user chooses to be reminded after the initial warning messages displays.

---

**Note:** The repeated warning message only occurs if the user opts to continue to a Web page after the initial warning message.

---

The default value is 5 minutes. This setting is configured per user/per category.

The warning message displays if the value for the policy rule's selected action is set to Warn. See [Creating a New Policy on page 10-6](#) for more information.

See [Configuring URL Access Warning Notifications on page 13-34](#) for more about the notifications.

## URL Filtering Exceptions

IWSVA provides the option to configure exceptions to URL filtering by approved lists (see [Specifying the Exceptions List on page 8-68](#)). URLs in the exception list will not be blocked or monitored. If your clients have a legitimate need to view Web sites that are being blocked or monitored by URL filtering, include the URL to an approved URL list and apply the list to the policy.

---

**Note:** IWSVA still applies Safe Search filtering to Web sites in the approved URL list.

---

**To apply an approved URL list to a URL filtering policy:**

1. Open the IWSVA Web console and click **HTTP > URL Filtering > Policies** and click a policy name to edit it.
2. In the **Exceptions** tab, select the approved URL list name.

---

**Note:** URLs in the exception list will not be warned. For more information, see [Configuring URL Access Warning Notifications on page 13-34](#).

---

3. Click **Save**.

## URL Filtering Time Quota Extension

The Time Quota extension is for the URL Filtering policies with a “Time Limit” action. If an IWSVA system admin would like to allow Internet browsing to continue for an individual after the time limit has been exhausted, the time period can be extended here. Users will receive a notification if the time quota has been reach. A log is recorded for users who exhaust their quotas.

This page shows the following information:

- **User**—Identifies user by name or IP address. Admins can also search for a user or sort by the users name.
- **Daily Time Quota Allotment**—Displays time allotted in a policies for the amount of time that can be used for browsing.
- **Extend Time Given**—Displays extended time given already, if any.
- **Daily Time Quota Used**—Displays the total of time used browsing, which may include the original time allotted plus any time extensions, or portions of time extensions that have been used.
- **Extend Quota**—Provides a place to configure the extension with:
  - **Check box**—Check to extend time
  - **Amount**—Numeric value of extension
  - **Units of measure**—Time in minutes or hours for the extension

---

**Note:** Time can only be extended for URL Filtering policies that have the “Time Limit” action as part of the policy rule.

---

**To extend the allotted time for Internet browsing:**

1. Go to **HTTP > Access Quota Policies > Time Quota URL Filtering Extension**.
2. Find the appropriate user by sorting the User column or using the search field.
3. Go to the Extend Quota column in the row of the appropriate user.
4. Check the check box to allow time to be extended.
5. Type the number of minutes or hours the extension will encompass and select the appropriate unit of time (hours or minutes).
6. Click **Save** for the extension to take effect.





# Chapter 11

## FTP Scanning

This chapter describes FTP virus scanning and the different ways FTP scanning can be deployed and configured for your environment.

Topics in this chapter include:

- [Introduction on page 11-2](#)
- [FTP Settings on page 11-2](#)
- [FTP Scanning Options on page 11-4](#)
- [Configuring FTP Scanning Settings on page 11-8](#)
- [Setting Scan Actions on Viruses on page 11-10](#)
- [FTP Access Control Settings on page 11-13](#)

## Introduction

InterScan Web Security Virtual Appliance (IWSVA) can scan FTP uploads and downloads for viruses and other malicious code in a manner similar to how it processes HTTP traffic. Unlike HTTP scanning, however, a single configuration is applied to all clients on your network—user or group-based policies are not supported for FTP scanning.

IWSVA FTP scanning uses either a stand-alone proxy or works in conjunction with another FTP proxy on the network. To deploy FTP scanning into your environment, first configure the FTP settings that control the type of proxy and the type of data connection (either passive or active FTP; see [Passive and Active FTP starting on page 11-3](#)). The next step is to configure the scanning rules that control the traffic direction that is scanned, the type of files to block or scan, how compressed and large files are handled, and the actions taken when malicious code is detected.

After setting the FTP scanning settings, there are optional security and performance settings to consider modifying. Access control lists can be configured to selectively allow client FTP access based on the client's IP address. To improve performance when frequently accessing FTP sites over which you have direct control of the content, specific FTP servers can be added to an approved list so that downloads from them are not scanned. Moreover, to further lock down the IWSVA device, FTP access to specific ports can either be allowed or denied.

---

**Note:** IWSVA does not support active FTP scanning in WCCP mode.

---

## FTP Settings

IWSVA FTP scanning settings include options for using either the IWSVA native (stand-alone) proxy or a separate FTP proxy, two options for how data connections are made (active FTP vs. passive FTP).

## Proxy Settings

IWSVA FTP scanning provides two proxy options—a “stand-alone” mode whereby clients connect to the native IWSVA proxy that later connects with the FTP server, and an “FTP proxy” mode whereby IWSVA passes requests through a separate FTP proxy that in turn connects to the FTP server.

- In stand-alone mode, the client needs to use `<username>@<FTP server name>` as the FTP username to indicate which FTP server IWSVA should connect to.
- In FTP proxy mode, no username is required because IWSVA always connects to the FTP proxy and server designated in the configuration settings.

FTP proxy mode can also be used to protect a single FTP server by specifying the FTP server’s hostname/IP address and port number in the FTP proxy configuration. In this case, the IWSVA FTP scanning module is dedicated to the specified FTP server, in a manner similar to a reverse proxy for HTTP scanning.

## Passive and Active FTP

IWSVA uses either active or passive FTP for data connections, depending on your firewall setting. FTP uses two ports, a data port and a command port. In *active* FTP, the server connects to the client to establish the data connection. In *passive* FTP, the client connects to the server.

When passive FTP is selected in the IWSVA configuration, IWSVA converts the “active” mode on the client side into the “passive” mode on the server side. Mode conversion is performed only when the IWSVA configuration is passive and the client uses the active mode. If the IWSVA configuration is active, no conversion is performed, so passive requests from the client are still passive requests on the server side.

## Client Requests

To configure the FTP settings, you need to specify the proxy settings and the data connection.

The FTP Proxy supports IPv6 FTP Proxies similar to the support of the IPv4 FTP Proxy, and the Web UI accepts both IPv4 and IPv6 addresses.

You can have IWSVA act as an FTP proxy server. If you need to protect FTP uploads on multiple servers, install one instance of the IWSVA FTP module for each server.

**To configure the FTP settings:**

1. Click **FTP > Configuration > General** from the main menu.
2. Under the **Proxy Settings** section, select the appropriate FTP setting based on your topology—either **Use stand-alone mode** if you want the native IWSVA proxy to connect to FTP sites, or **Use FTP proxy** for the FTP service to work with an existing FTP proxy (specify the host name of the **Proxy server** and the **Port**).
3. Choose the type of data connection to use—either **Passive FTP** or **Active FTP**.
4. Click **Save**.

## FTP Scanning Options

IWSVA can scan FTP traffic for both IPv4 and IPv6 servers based on predefined policies.

For the Proxy Deployment mode, IWSVA supports the deployment scenarios that follow and can auto-transition for FTP, HTTP, and HTTPS traffic between the IPv4 and IPv6 networks when deploying IWSVA as a dual stack network environment. This means the IPv4 client can also access an IPv6 server or an IPv6 client can access an IPv4 host with an IWSVA proxy along with an IPv4 client accessing an IPv4 client and an IPv6 client access IPv4 server.

**TABLE 11-1. Proxy Deployment Mode Scanning Scenarios Supported**

No.	CLIENT	SERVER	SUPPORTED (Y/N)
1	IPv4	IPv4	Y
2	IPv6	IPv6	Y
3	IPv4	IPv6	Y
4	IPv6	IPv4	Y

For other supported deployment modes, IWSVA cannot transition between IPv4 and IPv6 networks as the following table shows.

**TABLE 11-2. Other Deployment Mode Scanning Scenarios Supported**

No.	CLIENT	SERVER	SUPPORTED (Y/N)
1	IPv4	IPv4	Y
2	IPv6	IPv6	Y
3	IPv4	IPv6	N
4	IPv6	IPv4	N

The FTP virus scanning settings are similar to the HTTP scanning settings, with two differences:

- FTP scanning does not support user or group-based policies; therefore, one configuration is applied to all clients that access the FTP sites through IWSVA.
- The traffic direction to scan can be configured—either to uploads, downloads, or both.

## Enabling FTP Traffic and FTP Scanning

Before your clients can access the FTP sites through IWSVA, the FTP traffic must be enabled.

### To enable or disable FTP scanning:

1. Open the IWSVA Web console and click **FTP > Scan Rules**.
2. Select **Enable FTP scanning**.
3. Click **Save**.

## Scan Direction

Depending on how you want to use IWSVA FTP scanning, you can selectively configure the FTP scanning module to scan uploads, downloads or both. For example, if you have deployed antivirus software to all of the workstations in your organization, disabling uploads might be justified to achieve a performance benefit, because the files should already be scanned on the client.

## File Blocking

You can specify the types of files to block for security, monitoring or performance purposes. You can block file types such as Java applets, Microsoft Office documents, audio/video files, executables, images, or other types that you can manually configure. If your organization has policies that prohibit certain types of files in your network, IWSVA FTP file blocking can stop them at the FTP gateway.

## File Scanning

When configuring the types of files to be scanned, there are three options:

- **All scannable files:** All files are scanned (the safest option).
- **IntelliScan:** Only file types known to harbor viruses are scanned (file type is determined by checking the file header). See [About IntelliScan starting on page 8-53](#) for more information.
- **Specified file extensions:** Only files with specified file extensions are scanned.

Trend Micro recommends scanning all files, unless performance considerations require choosing one of the other options. See [Configuring FTP Scanning Settings](#) on page 11-8 for more information.

## Priority for FTP Scan Configuration

If the configurations on the **FTP Virus Scan** screen conflict with each other, the program scans according to the following priority:

1. Block these file types
2. Scan these file types (if not blocked)

## Intellitrapp

Detects potentially malicious code in real-time, compressed executable files that arrive with HTTP data. Virus writers often attempt to circumvent virus filtering by using different file compression schemes. IntelliTrap provides heuristic evaluation of compressed files that help reduce the risk that a virus compressed using these methods will enter a network through the Web. Malicious, compressed executable files receive the actions specified in the Action tab. IntelliTrap is enabled by default.

## Compressed File Handling

Compressed files can pose special challenges to antivirus software performance, because they must be decompressed before the individual files within the archive can be scanned. IWSVA provides the option to block, quarantine, or pass all compressed files at the gateway.

Alternatively, you can also configure IWSVA to apply the selected action on compressed files that meet one of the following conditions:

- Decompressed file count exceeds a given threshold
- Cumulative decompressed file size exceeds a configured maximum
- Recursively compressed file exceeds a certain number of compressed layers

---

**Note:** IWSVA can also block specified file types within a compressed file during FTP scanning.

---

## Large File Handling

If the delay when downloading large files is unacceptable, IWSVA can be configured to skip scanning of files larger than a configured threshold. Additionally, the FTP scanning module can use the “deferred scanning” method for large files to prevent the client connection from timing out. See [Deferred Scanning starting on page 8-61](#) for more information.

---

**Note:** The FTP scanning module does not support the “scan before delivering” large file handling methods used by the HTTP scanning module.

---

## Encrypting Quarantined Files

If IWSVA is configured to quarantine files as a scan action, it can optionally encrypt the files to prevent them from accidentally being executed by someone browsing the quarantine folder. Note that after encrypted, the files can only be decrypted by a representative from Trend Micro's Support department.

## Scanning for Spyware/Grayware

IWSVA can scan for many additional non-virus risks for which patterns are contained in the spyware/grayware pattern file. For a summary of these risks, see [Spyware and Grayware Scanning Rules starting on page 8-64](#).

## Data Loss Prevention

IWSVA can scan for data loss using the policies you create in **HTTP > Data Loss Prevention > Policies**. In **FTP > Scan Rules | Data Loss Prevention** tab, select the name of the DLP template and then modify scan criteria based on whether you would like allow, block or monitor using specific filtering you apply.

## FTP Scanning Exception List

You can apply an approved list that contains the names of files that you want to exempt from file type blocking. In addition, you can configure IWSVA to bypass virus/spyware scanning and compressed file handling action on files in an approved list.

For more information, see [Specifying the Exceptions List on page 8-68](#).

## Configuring FTP Scanning Settings

**To configure FTP scanning:**

1. Click **FTP > Scan Rules** from the main menu.
2. Select **Enable FTP scanning**.
3. Select the types of FTP transfers to scan—either **Upload**, **Download**, or both.
4. Under the **Block these file types** section, select the file types to be blocked. In the **Other file types** field, type other file types to block (use a space to delimit multiple



entries). See Appendix B, *Mapping File Types to MIME Content-types* for a list of other file types that can be blocked.

5. Select the files to scan:
  - To scan all file types regardless of extension, select **All scannable files**. IWSVA opens compressed files and scans all files within. Scanning all files is the most secure configuration.
  - To use true-file type identification, select **IntelliScan**. IntelliScan uses a combination of true attachment type scanning and exact extension name scanning. True attachment type scanning recognizes the file type even when the file extension has been changed. IntelliScan automatically determines which scanning method to use.
  - To scan file types based on their extensions, select **Specified file extensions**. This contains the list of file types known to harbor viruses. IWSVA scans only those file types that are explicitly specified in the **Default Extensions** list and in the **Additional Extensions** text box. The default list of extensions is periodically updated from the virus pattern file.  
Use this option, for example, to decrease the aggregate number of files IWSVA checks, therefore, decreasing the overall scan times.

---

**Note:** There is no limit to the number or types of files you can specify. Do not precede an extension with the (\*) character. Delimit multiple entries with a semicolon.

---

6. Under **Compressed file handling**, select an action (Block, Quarantine, or Pass) and select to apply the action to one of the following:
  - All compressed files
  - Compressed files ifIf you enable the second option, type a value for the following parameters:
  - Decompressed file count exceeds (default is 50000)
  - Size of a decompressed file exceeds (default is 200MB)
  - Number of layers of compression exceeds (0-20, default is 10)
  - Compression ratio of any file in the archive exceeds 99 percent
7. Under **Large File Handling**, select **Do not scan files larger than** and enter the file size.

8. To avoid browser time-out issues when downloading large files, select **Enable Deferred Scan** and type the file size above which deferred scanning occurs. Also, select from the drop-down list the percentage of data to be sent to the client unscanned.

---

**WARNING!** The partial delivery of a file might result in a virus leak; therefore, this would be a performance versus an absolute security choice for you. Use this option only when you are currently experiencing an issue with time-outs.

---

9. To encrypt files sent to the quarantine directory to prevent them from being inadvertently opened or executed, select **Encrypt quarantined files**.
10. Click **Save** and switch to the **Spyware/Grayware Scan Rule** tab.
11. Select the types of additional risks to scan for, and click **Save**.
12. In the **Data Loss Prevention** tab, select a DLP Template you have previously created at **HTTP > Data Loss Prevention > Policies** from the DLP Template list.
13. Modify filtering rules and determine whether to Scan, Block, or Monitor with the filter. Click **Save**.
14. In the **Exceptions** tab, select an approved file name list from the drop-down list. Select **Do not scan the contents of selected approved lists** if you do not want to scan the contents of the files in the approved lists for viruses. In addition, compressed file handling action will not be applied.
15. Switch to the **Action** tab, and select the actions for IWSVA to take in response to scanning.
16. Click **Save**.

## Setting Scan Actions on Viruses

You can specify the action for FTP scanning to take upon finding an infected file (the recommended action setting is **Clean**):

- Choose **Quarantine** to move an infected file to the quarantine directory without cleaning. The requesting client does not receive the file.

- Choose **Delete** to delete an infected file at the server. The requesting client does not receive the file.
- Choose **Clean** to automatically clean and process an infected file. The requesting client receives the cleaned file if it is cleanable.

You can specify the action for FTP scanning to take upon finding an uncleanable file, which includes worms and Trojans (the recommended action setting is **Delete**):

- Choose **Pass** to send an uncleanable file to the client without cleaning (Trend Micro does not recommend this choice, because it might allow infected files into your network).
- Choose **Quarantine** to move, without cleaning, an uncleanable file to the quarantine directory. The requesting client does not receive the file.
- Choose **Delete** to delete an uncleanable file at the server. The requesting client does not receive the file.

You can specify the action for FTP scanning to take in handling a password-protected compressed file (the recommended action setting is **Pass**):

- Choose **Pass** to send a password-protected file to the client without cleaning.
- Choose **Quarantine** to move, without cleaning, a password-protected file to the quarantine directory. The requesting client does not receive the file.
- Choose **Delete** to delete a password-protected file at the server. The requesting client does not receive the file.

In the event a file containing macros (not necessarily macro viruses) is detected during FTP transfers, the following actions are available (the recommended action setting is **Pass**):

- Choose **Quarantine** to move the files containing macro(s) to the quarantine directory.
- Choose **Clean** to remove macros before delivering the file.
- Choose **Pass** to disable special handling of files containing macro(s).

## FTP General Configuration Settings

To configure the FTP settings, you need to specify the proxy settings and the data connection.

The FTP Proxy supports IPv6 FTP Proxies similar to the support of the IPv4 FTP Proxy, and the Web UI accepts both IPv4 and IPv6 addresses.

You can have IWSVA act as an FTP proxy server. If you need to protect FTP uploads on multiple servers, install one instance of the IWSVA FTP module for each server.

## Proxy Settings

- **Use stand-alone mode**—Choose this option when IWSVA is installed as the only FTP proxy on the network.
- **Use FTP Proxy**—Choose this option if IWSVA is installed on a network with an existing FTP proxy; IWSVA may be on the same machine as the FTP proxy or a different one, which will affect the values you enter for the following fields:
  - **Proxy server**—Specify the host name or IP address of the FTP proxy that IWSVA receives FTP traffic from; If IWSVA FTP scanning is installed on the same machine as the FTP server, use "localhost"
  - **Port**—Indicates the port number that the FTP proxy uses to deliver FTP traffic to IWSVA, typically, port 21

## Data Connection

Because most firewalls are configured to reject unsolicited port requests from outside the LAN, IWSVA supports both Active and Passive file transfers. Passive transfers are usually necessary if there is a firewall on the LAN, or if you have experienced failed data channels when trying to setup Active FTP.

Click **FTP > Configuration > General** from the main menu.

- **Passive FTP**—Choose this option if IWSVA is running inside a firewall that allows only Passive FTP.

In Passive FTP (or PASV mode), the FTP client initiates contact with the FTP server. The FTP server tells the client to which port to connect for data transfer and the client opens another connection to the server on this port.
- **Active FTP**—Choose this option if IWSVA was installed as a Stand-alone, is running inside a firewall that allows Active FTP, or if it was installed to be running outside the firewall (not recommended).

In Active FTP, the FTP client initiates contact with the FTP server and then negotiates a mutual data transfer port. (Port 22020 is usually used in IWSVA.) The server connects back to the client using the negotiated port.

---

**Note:** Your firewall must be able to open this port dynamically and let the FTP server communicate with the client, or you must manually open the port.

---

---

**Note:** The maximum number of client requests and number of worker threads to create can be manually configured by editing the intscan.ini file.

---

## FTP Access Control Settings

IWSVA includes several access control settings for additional security and performance tuning:

- FTP access can be enabled based on the client's IP address.
- Trusted servers over which you have close control of their content and are frequently accessed can be added to an approved list and transfers are not scanned for a performance benefit.
- The IWSVA FTP server can be locked down by denying access to ports that you configure.

### By Client IP

By default, all clients on the network are allowed to access FTP sites through the IWSVA device (provided FTP traffic is enabled, see [Enabling FTP Traffic and FTP Scanning starting on page 11-5](#)).

When selecting policies, both IPv4 and IPv6 policies will appear. Client Access Control accepts a single IPv6 address, an IPv6 range, or an IPv6 mask similar to what has been supported with IPv4.

**To limit FTP access based on client IP address:**

1. Click **FTP > Configuration > Access Control Settings** from the main menu.
2. Switch to the **Client IP** tab.

3. Select **Enable FTP Access Based on Client IP**.
4. Enter the IP addresses of clients allowed FTP access through IWSVA. The following are acceptable entries:
  - **IP/Hostname**: a single IP address, for example, 123.123.123.12.
  - **IP range**: clients that fall within a contiguous range of IP addresses, for example, from 123.123.123.12 to 123.123.123.15.
  - **IP mask**: a single client within a specified subnet, for example, entering IP = 192.168.0.1 and Mask = 255.255.255.0 identifies all machines in the 192.168.0.x subnet. Alternatively, the Mask can be specified as a number of bits (0 to 32).
5. Type a descriptive name in the **Description** field. (40 characters maximum)
6. Click **Add** and continue entering other clients that are allowed to access FTP sites.
7. Click **Save**.

## Via Approved Server IP List

To reduce possible performance issues when accessing trusted FTP sites over which you directly control the content, you can exempt some FTP sites from scanning by adding their IP addresses to an approved list.

---

**Note:** Skipping scanning through the IP approved list only applies to file downloads. Uploaded files are still scanned.

---

When selecting policies, both IPv4 and IPv6 policies will appear. Server Access Control accepts a single IPv6 address, an IPv6 range, or an IPv6 mask similar to what has been supported with IPv4.

### To add trusted servers to the approved list:

1. Click **FTP > Configuration > Access Control Settings** from the main menu.
2. Switch to the **Approved Server IP List** tab.
3. Enter the IP addresses of FTP sites to exempt from IWSVA FTP virus scanning. See [Identifying Clients and Servers starting on page 6-13](#) for information and examples about how to identify the servers.
4. Type a descriptive name in the **Description** field. (40 characters maximum)
5. Click **Add** and continue entering other FTP sites to exempt.

6. Click **Save**.

## Via Destination Ports

By default, clients can access any port on the IWSVA FTP server. To increase security, you can selectively allow or deny access to the ports.

### To configure IWSVA FTP ports to which clients can connect:

1. Click **FTP > Configuration > Access Control Settings** from the main menu.
2. Switch to the **Destination Ports** tab.
3. Choose the action to apply to a port, either **Deny** or **Allow**.
4. Enter the **Port** or **Port Range** to which the action applies.
5. Type a descriptive name in the **Description** field. (40 characters maximum.)
6. Click **Add**.
7. Continue to add other ports to allow or deny.
8. Click **Save**.

---

**Note:** The destination port list at the bottom of the **Destination Port** tab reflects the processing order (or reverse priority order). Destination port access control is only applied during an FTP command connection, and FTP data connections are not affected. A typical configuration is 1. “Deny ALL” and 2. “Allow 21” which results in only allowing access to port 21.

---





# Chapter 12

## Command Line Interface Commands

This chapter describes the Command Line Interface (CLI) commands that you can use in the InterScan Web Security Virtual Appliance (IWSVA) product to perform monitoring, debugging, troubleshooting, and configuration tasks.

CLI commands allow administrators to perform additional configuration tasks, such as enabling and disabling Squid caching, and to perform debug and troubleshooting functions. The CLI interface also provides additional commands to monitor critical resources and functions, such as monitoring the traffic that flows in or out of a network interface.

Topics included in this chapter are:

- [SSH Access starting on page 12-2](#)
- [Command Modes starting on page 12-3](#)
- [Command List starting on page 12-3](#)

## SSH Access

Access to the IWSVA CLI interface can be obtained through the IWSVA terminal (keyboard and monitor connected directly to the IWSVA server) or remotely using a SSH v2 connection to the management IP address. Before you access the CLI using SSH, you must first enable SSH access control in the Web console (**Administration > Network Configuration > Remote CLI**).

## Preventing Password Brute Force Attacks through SSH

IWSVA can protect against password brute force attacks. If a remote terminal attempts to log on to IWSVA with the wrong password using SSH, IWSVA will reject subsequent log on attempts. This feature is enabled and disabled through the CLI.

### To enable the anti-password brute force attack function:

1. Log on to IWSVA using the root, enable, or admin account. “root” and “admin” account users can log on using SSH, but the “enable” account users can only log on to the IWSVA local machine.
  - If logging on with the root account, type **clish** and **enable** to access the clish privileged mode.
  - If logging on with the admin account, type **enable** to access the clish privileged mode.
  - If logging on with the enable account, you are already in the clish privileged mode.
2. To enable the function, type the following command: **configure service pswd\_protection enable**

### To disable the anti-password brute force attack function:

1. Follow Step 1 in the previous procedure.
2. To disable the function, type the following command: **configure service pswd\_protection disable**.

## Command Modes

To access the command line interface, you will need to have the administrator account and password. IWSVA's CLI commands are separated into two categories—non-privileged and privileged commands.

Non-privileged commands are basic commands that allow the administrator to obtain specific low security risk information and to perform simple tasks. The non-privileged command prompt ends with an angle bracket (>).

Privileged commands provide full configuration control and advanced monitoring and debugging features. To use privileged commands, type `enable` and the password for the Enable account. The screen displays `enable#` as the privileged command prompt. To return to non-privileged commands, type `exit`.

---

**Note:** Some CLI commands are not available to child members of an HA cluster. because these parameters need to be configured through the parent member of the cluster. Some of the commands unavailable through the child server are: `configure system date`, `configure module ntp`, `configure system password`, `configure service ssh`, and `configure system timezone`

---

## Command List

---

**Note:** Commands have been standardized. Commands with syntax changes from a previous release show the new command syntax first, followed by the replaced command syntax. For example:

```
start shell
```

**Replaces:**

```
admin shell
```

---

The following table lists the available commands:

**TABLE 12-1. Command Line Interface Commands**

COMMAND	SYNTAX	DESCRIPTION
configure module database password <b>Replaces:</b> configure db password	configure module database password	Configure the database password
configure module http bypass_non_http disable <b>Replaces:</b> disable bypass_non_http	configure module http bypass_non_http disable	Disable non-HTTP traffic bypass
configure module http bypass_non_http enable <b>Replaces:</b> enable bypass_non_http	configure module http bypass_non_http enable	Enable non-HTTP traffic bypass
configure module http scan_before_deliver_port <port> <b>Note:</b> This is a new command.	configure module http scan_before_deliver_port <port> [mgmt_interface]	Configure both IPv4 and IPv6 addresses for the redirecting port to scan before delivery. IPv4 and IPv6 redirect requests will be sent directly to the client.
configure module http x-forwarded-for action add <b>Note:</b> This is a new command.	configure module http x-forwarded-for action add	Add the IP address of the last hop to the XFF HTTP header

**TABLE 12-1. Command Line Interface Commands (Continued)**

<b>COMMAND</b>	<b>SYNTAX</b>	<b>DESCRIPTION</b>
configure module http x-forwarded-for action keep <b>Note:</b> This is a new command.	configure module http x-forwarded-for action keep	Make no changes in the XFF HTTP header
configure module http x-forwarded-for action remove <b>Note:</b> This is a new command.	configure module http x-forwarded-for action remove	Remove the XFF HTTP header from the HTTP request for upstream security
configure module http x-forwarded-for parse disable <b>Note:</b> This is a new command.	configure module http x-forwarded-for parse disable	Disable parsing of the XFF HTTP header
configure module http x-forwarded-for parse enable <b>Note:</b> This is a new command.	configure module http x-forwarded-for parse enable	Enable parsing of the XFF HTTP header to obtain the original IP address for policy matching
configure module https hardware_engine cavium	configure module https hardware_engine cavium	Use "cavium" hardware accelerate card; this operation requires that the hardware card be inserted into the machine
configure module https hardware_engine none	configure module https hardware_engine none	Do not use SSL hardware accelerate card

**TABLE 12-1. Command Line Interface Commands (Continued)**

COMMAND	SYNTAX	DESCRIPTION
configure module https logaccfullurl <b>Replaces:</b> <disable   enable> https logaccfullurl	configure module https logaccfullurl <enable/disable>	Configure logaccfullurl
configure module identification mac_address <enable/disable> <b>Replaces:</b> configure mac address no configure mac address yes	configure module identification mac_address <enable/disable>	Include/exclude MAC address for hostname identification method
configure module ldap groupcache interval <b>Replaces:</b> configure ldap groupcache interval <interval>	configure module ldap groupcache interval <interval>	Configure IWSVA LDAP user group membership cache interval  <i>interval</i> <u>UINT</u> interval (in hours)
configure module ldap ipuser_cache disable <b>Replaces:</b> configure ldap ipuser_cache disable	configure module ldap ipuser_cache disable	Disable IWSVA LDAP IP user cache
configure module ldap ipuser_cache enable <b>Replaces:</b> configure ldap ipuser_cache enable	configure module ldap ipuser_cache enable	Enable IWSVA LDAP IP user cache

TABLE 12-1. Command Line Interface Commands (Continued)

COMMAND	SYNTAX	DESCRIPTION
configure module ldap ipuser_cache interval <b>Replaces:</b> configure ldap ipuser_cache interval <interval>	configure module ldap ipuser_cache interval <interval>	Configure IWSVA LDAP IP user cache interval <i>interval</i> <u>FLOAT</u> interval (in hours)
configure module ldap www-auth port <b>Replaces:</b> configure www-auth port <port>	configure module ldap www-auth port <port>	Configure the user/group authentication port in transparent mode (WCCP or bridge mode)
configure module log transaction disable <b>Note:</b> This is a new command.	configure module log transaction disable	Disable the Transaction Log
configure module log transaction enable <b>Note:</b> This is a new command.	configure module log transaction enable	Enable the Transaction Log
configure module log transaction filter disable <b>Note:</b> This is a new command.	configure module log transaction filter disable	Disable the Transaction Log filter.

**TABLE 12-1. Command Line Interface Commands (Continued)**

COMMAND	SYNTAX	DESCRIPTION
configure module log transaction filter enable <b>Note:</b> This is a new command.	configure module log transaction filter enable <fromip> <toip>	Enable the Transaction Log filter. PARAM name: "fromip" IP address AAA.BBB.CCC.DDD where each part is in the range 0-255 PARAM name: "toip" IP address AAA.BBB.CCC.DDD where each part is in the range 0-255
configure module log verbose filter disable <b>Note:</b> This is a new command.	configure module log verbose filter disable	Disable verbose log filter
configure module log verbose filter enable <b>Note:</b> This is a new command.	configure module log verbose filter enable <fromip> < toip>	Enable verbose log filter
configure module log verbose ftp disable <b>Replaces:</b> disable verbose ftp	configure module log verbose ftp disable	Disable verbose FTP logs
configure module log verbose ftp enable <b>Replaces:</b> enable verbose ftp	configure module log verbose ftp enable	Enable verbose FTP logs



**TABLE 12-1. Command Line Interface Commands (Continued)**

<b>COMMAND</b>	<b>SYNTAX</b>	<b>DESCRIPTION</b>
configure module log verbose http disable <b>Replaces:</b> disable verbose http	configure module log verbose http disable	Disable verbose HTTP logs
configure module log verbose http enable <b>Replaces:</b> enable verbose http	configure module log verbose http enable	Enable verbose HTTP logs
configure module log verbose wccp disable <b>Replaces:</b> disable verbose wccp	configure module log verbose wccp disable	Disable verbose WCCP logs
configure module log verbose wccp enable <b>Replaces:</b> enable verbose wccp	configure module log verbose wccp enable	Enable verbose WCCP logs
configure module ntp schedule <enable/disable> <b>Replaces:</b> disable ntp schedule enable ntp schedule	configure module ntp schedule <enable/disable>	Enable or disable scheduled NTP time synchronization

**TABLE 12-1. Command Line Interface Commands (Continued)**

COMMAND	SYNTAX	DESCRIPTION
configure module ntp schedule <b>Replaces:</b> configure ntp schedule <interval> <primary_server> [secondary_server]	configure module ntp schedule <interval> <primary_server> [secondary_server]	Configure scheduled NTP time synchronization <i>interval</i> (30m, 1h, 2h, 4h, 6h, 12h, 1d, 2d, 3d, 1w, 1M) <i>primary_server</i> <u>ADDRESS</u> Primary NTP server <i>secondary_server</i> <u>ADDRESS</u> Secondary NTP server
configure module ntp sync <b>Replaces:</b> configure ntp sync <server>	configure module ntp sync <server>	Configure IPv4 and IPv6 NTP server synchronization <i>server</i> <u>ADDRESS</u> NTP server
configure network bonding add	configure network bonding add <bondingname> [interface1] [interface2] [interface3] [interface4]	Add a link aggregation bonding interface <bondingname> is the name of the bonding interface

TABLE 12-1. Command Line Interface Commands (Continued)

COMMAND	SYNTAX	DESCRIPTION
configure network bonding options miimon	configure network bonding options miimon <interval>	Configure miimon options of specified bonding device <interval> is the specific miimon interval to be set. Default is 100. <hr/> <b>Note:</b> Miimon is a value setup in milliseconds. <hr/>
configure network bonding options xmit_hash_policy	configure network bonding options xmit_hash_policy <policy>	Configure xmit_hash_policy options of specified bonding device <policy> is the specific xmit_hash_policy to be set Default is 1 (3layer). 0 (2layer) is also available.
configure network bonding remove	configure network bonding remove <bondingname>	Remove a link aggregation bonding interface <bondingname> is the name of the bonding interface

**TABLE 12-1. Command Line Interface Commands (Continued)**

COMMAND	SYNTAX	DESCRIPTION
configure network bridge interface  <b>Replaces:</b> configure bridge interface <internal> <external>	configure network bridge interface [interface1] [interface2] [interface3] [interface4] [interface5] [interface6] [interface7] [interface8]	Configure the default bridge interface  <i>internal</i> IFNAME Interface name or link aggregation bonding name  <i>external</i> IFNAME Interface name or link aggregation bonding name
configure network bridge redirect ftpports  <b>Replaces:</b> configure redirect ftpports <ports>	configure network bridge redirect ftpports <ports>	Configure the redirection ftp ports  <i>ports</i> <u>MULTIPORTS</u> Redirect ports <port1;port2;...>
configure network bridge redirect httpports  <b>Replaces:</b> configure redirect ftpports <ports>	configure network bridge redirect httpports <ports>	Configure the redirection HTTP ports  <i>ports</i> <u>MULTIPORTS</u> Redirect ports <port1;port2;...>
configure network bridge redirect httpsports  Replaces: configure redirect httpsports <ports>	configure network bridge redirect httpsports <ports>	Configure the redirection HTTPS ports  <i>ports</i> <u>MULTIPORTS</u> Redirect ports <port1;port2;...>
configure network bridge stp  <b>Note:</b> This is a new command.	configure network bridge stp	Configure the default bridge STP settings

TABLE 12-1. Command Line Interface Commands (Continued)

COMMAND	SYNTAX	DESCRIPTION
configure network bridge stp disable <b>Note:</b> This is a new command.	configure network bridge stp disable	Disable STP on IWSVA
configure network bridge stp enable <b>Note:</b> This is a new command.	configure network bridge stp enable	Enable STP on IWSVA
configure network bridge stp priority <b>Note:</b> This is a new command.	configure network bridge stp priority	Set the STP priority of IWSVA
configure network dns ipv4 <b>Replaces:</b> configure dns	configure network IPv4 dns <dns1> [dns2]	Configure DNS settings <i>dns1</i> <u>IP_ADDR</u> Primary IPv4 DNS server <i>dns2</i> <u>IP_ADDR</u> Secondary IPv4 DNS server
configure network dns ipv6 <b>Replaces:</b> configure dns	configure network IPv6 dns <dns1> [dns2]	Configure DNS settings <i>dns1</i> <u>IP_ADDR</u> Primary IPv6 DNS server <i>dns2</i> <u>IP_ADDR</u> Secondary IPv6 DNS server
configure network hostname <b>Replaces:</b> configure hostname	configure network hostname <hostname>	Configure the hostname hostname <u>HOSTNAME</u> Hostname or FQDN

**TABLE 12-1. Command Line Interface Commands (Continued)**

<b>COMMAND</b>	<b>SYNTAX</b>	<b>DESCRIPTION</b>
<pre>configure network interface ipv4 dhcp &lt;network_interface_name&gt; [vlan]</pre> <p><b>Replaces:</b></p> <pre>configure mgmt ip static &lt;ip&gt; &lt;mask&gt;</pre> <p><b>Note:</b> The old command does not map directly to the new command. Changes were made to support the updated release.</p>	<pre>configure network interface ipv4 dhcp &lt;network_interface_name&gt; [vlan]</pre>	<p>Configure the default Ethernet interface to use DHCP to obtain the IPv4 address.</p> <p>vlan VLAN_ID Vlan ID [1-4094], default none Vlan: [0]</p>
<pre>configure network interface ipv6 dhcp &lt;network_interface_name&gt; [vlan]</pre> <p><b>Replaces:</b></p> <pre>configure mgmt ip static &lt;ip&gt; &lt;mask&gt;</pre> <p><b>Note:</b> The old command does not map directly to the new command. Changes were made to support the updated release.</p>	<pre>configure network interface ipv6 dhcp &lt;network_interface_name&gt; [vlan]</pre>	<p>Configure the default Ethernet interface to use DHCP to obtain the IPv6 address.</p> <p>vlan VLAN_ID Vlan ID [1-4094], default none Vlan: [0]</p>
<pre>configure network interface duplex</pre> <p><b>Replaces:</b></p> <pre>configure ethernet duplex &lt;ethname&gt; &lt;duplex&gt;</pre>	<pre>configure network interface duplex &lt;ethname&gt; &lt;duplex&gt;</pre>	<p>Configure the duplex of the Ethernet interface</p>

TABLE 12-1. Command Line Interface Commands (Continued)

COMMAND	SYNTAX	DESCRIPTION
configure network interface ping <interface_name> <action> <b>Replaces:</b> enable/disable ping [mgmt]	configure network interface ping <interface_name> <enable/disable>	Accept/disallow ICMP-request on the separated management interface
configure network interface ipv4 static <b>Replaces:</b> configure ip static <ip> <mask> <gateway> [vlan]	Configure the network interface to use ipv4 static. <interface_name> <IPv4 address> <network mask> [vlan]	Configure the default Ethernet interface to use the static IPv4 configuration.
configure network interface ipv6 static <b>Replaces:</b> configure ip static <ip> <mask> <gateway> [vlan]	Configure the network interface to use ipv6 static. <interface_name> <IPv6 address> <network mask> [vlan]	Configure the default Ethernet interface to use the static IPv6 configuration.
configure network lanbypass auto	configure network lanbypass auto	The system auto-adjusts the LAN bypass status.
configure network lanbypass off	configure network lanbypass off	Never bypass traffic
configure network lanbypass on	configure network lanbypass on	Always bypasses traffic
configure network mgmt disable	configure network mgmt disable	Disable the separate IWSVA management interface

**TABLE 12-1. Command Line Interface Commands (Continued)**

COMMAND	SYNTAX	DESCRIPTION
configure network mgmt interface <b>Replaces:</b> configure mgmt interface <interface_name>	configure network mgmt interface <interface_name>	Configure IWSVA management interface name
configure network portgroup add  <b>Note:</b> This is a new command.	configure network portgroup add <pgname> [interface1] [interface2] [interface3] [interface4] [interface5] [interface6] [interface7] [interface8]	Add a port group
configure network portgroup linkloss <pgname>  <b>Note:</b> This is a new command.	configure network portgroup linkloss <pgname>	Configure the port group link loss forward settings
configure network portgroup remove <pgname>  <b>Note:</b> This is a new command.	configure network portgroup remove <pgname>	Remove a port group
configure network portgroup vlan <pgname>  <b>Note:</b> This is a new command.	configure network portgroup vlan <pgname>	Configure the port group VLAN ID



TABLE 12-1. Command Line Interface Commands (Continued)

COMMAND	SYNTAX	DESCRIPTION
configure network proxy interface <b>Replaces:</b> configure proxy interface <proxy>	configure network proxy interface <proxy>	Configure the default proxy interface <i>proxy</i> <u>IFNAME</u> Interface name
configure network route ipv4/ipv6 add <ip_prefixlen> <via> <dev> <b>Note:</b> This is a new command.	configure network route ipv4/ipv6 add <xxx.xxx.xxx.xxx/LL> <via> <device>	Add a route for a specified NIC device in VA
configure network route ipv4/ipv6 default <gateway> <b>Replaces:</b> configure ip dhcp [vlan] <b>Note:</b> The old command does not map directly to the new command. Changes were made to support the updated release.	configure network route ipv4/ipv6 default <gateway>	Reset the default gateway by executing configure network route default <*. *.*.*>
configure network route ipv4/ipv6 del <ip_prefixlen> <via> <dev> <b>Note:</b> This is a new command.	configure network route ipv4/ipv6 del <xxx.xxx.xxx.xxx/LL> <via> <device>	Delete a route for a specified NIC device in VA

**TABLE 12-1. Command Line Interface Commands (Continued)**

COMMAND	SYNTAX	DESCRIPTION
configure service pswd_protection disable  <b>Note:</b> This is a new command.	configure service pswd_protection disable	Disable SSH password protection service
configure service pswd_protection enable  <b>Note:</b> This is a new command.	configure service pswd_protection enable	Enable SSH password protection service
configure service recycle time  <b>Note:</b> This is a new command.	configure service recycle time <hh:mm>	Enable recycling by time PARAM name "time" Use hh:mm time format between 00:00 and 23:59
configure service recycle disable time  <b>Note:</b> This is a new command.	configure service recycle disable time	Disable recycling by time
configure service recycle transaction  <b>Note:</b> This is a new command.	configure service recycle transaction <TRANSACTION_NUMBER>	Enable recycling by transaction PARAM name "transaction" Daemon will recycle after 100000-99999999 transaction(s)
configure service recycle disable transaction  <b>Note:</b> This is a new command.	configure service recycle disable transaction	Disable the transaction recycling

TABLE 12-1. Command Line Interface Commands (Continued)

COMMAND	SYNTAX	DESCRIPTION
configure service ssh disable <b>Replaces:</b> disable ssh	configure service ssh disable	Disable the SSH daemon
configure service ssh enable <b>Replaces:</b> enable ssh	configure service ssh enable	Enable the SSH daemon
configure service ssh port <b>Replaces:</b> configure ssh port <port>	configure service ssh port <port>	Configure SSH port number <i>port</i> <u>PORT</u> SSH port number [1 ~ 65535]
configure system date <b>Replaces:</b> configure date	configure system date <date> <time>	Configure date and save to CMOS <i>date</i> DATE_FIELD [DATE_FIELD] <i>time</i> TIME_FIELD [TIME_FIELD]
configure system ha <b>Note:</b> This is a new command.	configure system ha	Configure high availability
configure system ha remove <b>Note:</b> This is a new command.	configure system ha remove	Remove HA configuration and reboot IWSVA

**TABLE 12-1. Command Line Interface Commands (Continued)**

COMMAND	SYNTAX	DESCRIPTION
configure system ha synchronization interval <b>Note:</b> This is a new command.	configure system ha synchronization interval	Configure the HA synchronization interval PARAM name: "Interval" Interval (in minutes) at which HA will synchronize settings to child server. Range in minutes: 5-60
configure system harddisk	configure system harddisk	Add new hard disk and extend IWSVA data partition space  <b>Note:</b> IWSVA only supports adding one new hard disk and extends the IWSVA data partition space each time.
configure system hwmonitor <b>Note:</b> This is a new command.	configure system hwmonitor	Configure system hardware monitoring information.
configure system hwmonitor interval <b>Note:</b> This is a new command.	configure system hwmonitor interval [1-60]	Configure hardware status polling in minutes. Range is 1-60 minutes. Default duration determined by the IPMI polling cycle.
configure system keyboard	configure system keyboard	Configure system keyboard layout type

TABLE 12-1. Command Line Interface Commands (Continued)

COMMAND	SYNTAX	DESCRIPTION
configure system keyboard us	configure system keyboard us	Configure system keyboard layout type to U.S. English
configure system password  <b>Replaces:</b> configure password	configure system password <user>	Configure account password  <i>user</i> <u>USER</u> The user name for which you want to change the password. The user could be 'enable', 'root' or any user in the IWSVA's Administrator group
<p><b>Note:</b> All “configure system timezone” commands replace the old “configure timezone” commands.</p>		
configure system timezone Africa Cairo	configure system timezone Africa Cairo	Configure timezone to Africa/Cairo location
configure system timezone Africa Harare	configure system timezone Africa Harare	Configure timezone to Africa/Harare location
configure system timezone Africa Nairobi	configure system timezone Africa Nairobi	Configure timezone to Africa/Nairobi location
configure system timezone America Anchorage	configure system timezone America Anchorage	Configure timezone to America/Anchorage location
configure system timezone America Bogota	configure system timezone America Bogota	Configure timezone to America/Bogota location

**TABLE 12-1. Command Line Interface Commands (Continued)**

<b>COMMAND</b>	<b>SYNTAX</b>	<b>DESCRIPTION</b>
configure system timezone America Buenos_Aires	configure system timezone America Buenos_Aires	Configure timezone to America/Buenos_Aires location
configure system timezone America Chicago	configure system timezone America Chicago	Configure timezone to America/Chicago location
configure system timezone America Chihuahua	configure system timezone America Chihuahua	Configure timezone to America/Chihuahua location
configure system timezone America Denver	configure system timezone America Denver	Configure timezone to America/Denver location
configure system timezone America Godthab	configure system timezone America Godthab	Configure timezone to America/Godthab location
configure system timezone America Lima	configure system timezone America Lima	Configure timezone to America/Lima location
configure system timezone America Los_Angeles	configure system timezone America Los_Angeles	Configure timezone to America/Los_Angeles location
configure system timezone America Mexico_City	configure system timezone America Mexico_City	Configure timezone to America/Mexico_City location
configure system timezone America New_York	configure system timezone America New_York	Configure timezone to America/New_York location
configure system timezone America Noronha	configure system timezone America Noronha	Configure timezone to America/Noronha

**TABLE 12-1. Command Line Interface Commands (Continued)**

<b>COMMAND</b>	<b>SYNTAX</b>	<b>DESCRIPTION</b>
configure system timezone America Phoenix	configure system timezone America Phoenix	Configure timezone to America/Phoenix
configure system timezone America Santiago	configure system timezone America Santiago	Configure timezone to America/Santiago
configure system timezone America St_Johns	configure system timezone America St_Johns	Configure timezone to America/St_Johns
configure system timezone America Tegucigalpa	configure system timezone America Tegucigalpa	Configure timezone to America/Tegucigalpa
configure system timezone Asia Almaty	configure system system timezone Asia Almaty	Configure timezone to Asia/Almaty location
configure system timezone Asia Baghdad	configure system timezone Asia Baghdad	Configure timezone to Asia/Baghdad location
configure system timezone Asia Baku	configure system timezone Asia Baku	Configure timezone to Asia/Baku location
configure system timezone Asia Bangkok	configure system timezone Asia Bangkok	Configure timezone to Asia/Bangkok location
configure system timezone Asia Calcutta	configure system timezone Asia Calcutta	Configure timezone to Asia/Calcutta location
configure system timezone Asia Colombo	configure system timezone Asia Colombo	Configure timezone to Asia/Colombo location
configure system timezone Asia Dhaka	configure system timezone Asia Dhaka	Configure timezone to Asia/Dhaka location

**TABLE 12-1. Command Line Interface Commands (Continued)**

<b>COMMAND</b>	<b>SYNTAX</b>	<b>DESCRIPTION</b>
configure system timezone Asia Hong_Kong	configure system timezone Asia Hong_Kong	Configure timezone to Asia/Hong_Kong location
configure system timezone Asia Irkutsk	configure system timezone Asia Irkutsk	Configure timezone to Asia/Irkutsk location
configure system timezone Asia Jerusalem	configure system timezone Asia Jerusalem	Configure timezone to Asia/Jerusalem location
configure system timezone Asia Kabul	configure system timezone Asia Kabul	Configure timezone to Asia/Kabul location
configure system timezone Asia Karachi	configure system timezone Asia Karachi	Configure timezone to Asia/Karachi location
configure system timezone Asia Katmandu	configure system timezone Asia Katmandu	Configure timezone to Asia/Katmandu location
configure system timezone Asia Krasnoyarsk	configure system timezone Asia Krasnoyarsk	Configure timezone to Asia/Krasnoyarsk location
configure system timezone Asia Kuala_Lumpur	configure system timezone Asia Kuala_Lumpur	Configure timezone to Asia/Kuala_Lumpur location
configure system timezone Asia Kuwait	configure system timezone Asia Kuwait	Configure timezone to Asia/Kuwait location
configure system timezone Asia Magadan	configure system timezone Asia Magadan	Configure timezone to Asia/Magadan location
configure system timezone Asia Manila	configure system timezone Asia Manila	Configure timezone to Asia/Manila location



**TABLE 12-1. Command Line Interface Commands (Continued)**

<b>COMMAND</b>	<b>SYNTAX</b>	<b>DESCRIPTION</b>
configure system timezone Asia Muscat	configure system timezone Asia Muscat	Configure timezone to Asia/Muscat location
configure system timezone Asia Rangoon	configure system timezone Asia Rangoon	Configure timezone to Asia/Rangoon location
configure system timezone Asia Seoul	configure system timezone Asia Seoul	Configure timezone to Asia/Seoul location
configure system timezone Asia Shanghai	configure system timezone Asia Shanghai	Configure timezone to Asia/Shanghai location
configure system timezone Asia Singapore	configure system timezone Asia Singapore	Configure timezone to Asia/Singapore location
configure system timezone Asia Taipei	configure system timezone Asia Taipei	Configure timezone to Asia/Taipei location
configure system timezone Asia Tehran	configure system timezone Asia Tehran	Configure timezone to Asia/Tehran location
configure system timezone Asia Tokyo	configure system timezone Asia Tokyo	Configure timezone to Asia/Tokyo location
configure system timezone Asia Yakutsk	configure system timezone Asia Yakutsk	Configure timezone to Asia/Yakutsk location
configure system timezone Atlantic Azores	configure system timezone Atlantic Azores	Configure timezone to Atlantic/Azores location
configure system timezone Australia Adelaide	configure system timezone Australia Adelaide	Configure timezone to Australia/Adelaide location

**TABLE 12-1. Command Line Interface Commands (Continued)**

<b>COMMAND</b>	<b>SYNTAX</b>	<b>DESCRIPTION</b>
configure system timezone Australia Brisbane	configure system timezone Australia Brisbane	Configure timezone to Australia/Brisbane location
configure system timezone Australia Darwin	configure system timezone Australia Darwin	Configure timezone to Australia/Darwin location
configure system timezone Australia Hobart	configure system timezone Australia Hobart	Configure timezone to Australia/Hobart location
configure system timezone Australia Melbourne	configure system timezone Australia Melbourne	Configure timezone to Australia/Melbourne location
configure system timezone Australia Perth	configure system timezone Australia Perth	Configure timezone to Australia/Perth location
configure system timezone Europe Amsterdam	configure system timezone Europe Amsterdam	Configure timezone to Europe/Amsterdam location
configure system timezone Europe Athens	configure system timezone Europe Athens	Configure timezone to Europe/Athens location
configure system timezone Europe Belgrade	configure system timezone Europe Belgrade	Configure timezone to Europe/Belgrade location
configure system timezone Europe Berlin	configure system timezone Europe Berlin	Configure timezone to Europe/Berlin location
configure system timezone Europe Brussels	configure system timezone Europe Brussels	Configure timezone to Europe/Brussels location

**TABLE 12-1. Command Line Interface Commands (Continued)**

<b>COMMAND</b>	<b>SYNTAX</b>	<b>DESCRIPTION</b>
configure system timezone Europe Bucharest	configure system timezone Europe Bucharest	Configure timezone to Europe/Bucharest location
configure system timezone Europe Dublin	configure system timezone Europe Dublin	Configure timezone to Europe/Dublin location
configure system timezone Europe Moscow	configure system timezone Europe Moscow	Configure timezone to Europe/Moscow location
configure system timezone Europe Paris	configure system timezone Europe Paris	Configure timezone to Europe/Paris location
configure system timezone Pacific Auckland	configure system timezone Pacific Auckland	Configure timezone to Pacific/Auckland location
configure system timezone Pacific Fiji	configure system timezone Pacific Fiji	Configure timezone to Pacific/Fiji location
configure system timezone Pacific Guam	configure system timezone Pacific Guam	Configure timezone to Pacific/Guam location
configure system timezone Pacific Honolulu	configure system timezone Pacific Honolulu	Configure timezone to Pacific/Honolulu location
configure system timezone Pacific Kwajalein	configure system timezone Pacific Kwajalein	Configure timezone to Pacific/Kwajalein location
configure system timezone Pacific Midway	configure system timezone Pacific Midway	Configure timezone to Pacific/Midway location
configure system timezone US Alaska	configure system timezone US Alaska	Configure timezone to US/Alaska location

**TABLE 12-1. Command Line Interface Commands (Continued)**

COMMAND	SYNTAX	DESCRIPTION
configure system timezone US Arizona	configure system timezone US Arizona	Configure timezone to US/Arizona location
configure system timezone US Central	configure system timezone US Central	Configure timezone to US/Central location
configure system timezone US East-Indiana	configure system timezone US East-Indiana	Configure timezone to US/East-Indiana location
configure system timezone US Eastern	configure system timezone US Eastern	Configure timezone to US/Eastern location
configure system timezone US Hawaii	configure system timezone US Hawaii	Configure timezone to US/Hawaii location
configure system timezone US Mountain	configure system timezone US Mountain	Configure timezone to US/Mountain location
configure system timezone US Pacific	configure system timezone US Pacific	Configure timezone to US/Pacific location
enable	enable	Enable administrative commands
exit	exit	Exit the session
ftpput	ftpput <url> <filename> [--active]	Upload file through FTP protocol  <i>url</i> <u>STRING</u> [ftp://username:password@hostname/path]  <i>filename</i> <u>FILENAME</u> The file name and path to upload  <i>active</i> <u>ACTIVETYPE</u> FTP active mode

TABLE 12-1. Command Line Interface Commands (Continued)

COMMAND	SYNTAX	DESCRIPTION
help	help	Display an overview of the CLI syntax
history	history [limit]	Display the current session's command line history
ping	ping [-c num_echos] [-i interval] <dest>	<p><i>-c num_echos</i> <u>UINT</u> Specify the number of echo requests to be sent [5]</p> <p><i>-i interval</i> <u>UINT</u> Wait interval seconds between sending each packet</p> <p><i>dest</i> <u>ADDRESS</u> Host name or IP address</p>
ping6	ping6 <IPv6 address>	Use this command to ping IPv6 hosts.
reboot	reboot [time]	<p>Reboot this machine after a specified delay or immediately</p> <p><i>time</i> <u>UINT</u> Time in minutes to reboot this machine [0]</p>
resolve	resolve <dest>	<p>Resolve an IP address on the network</p> <p><i>dest</i> <u>ADDRESS</u> Remote ip address to resolve</p>

**TABLE 12-1. Command Line Interface Commands (Continued)**

<b>COMMAND</b>	<b>SYNTAX</b>	<b>DESCRIPTION</b>
resolve6	resolve6 <IPv6 dest>	Resolve an IPv6 IP address on the network <i>dest</i> <u>ADDRESS</u> Remote ipv6 address to resolve
restart service database <b>Replaces:</b> service database restart	restart service database	Restart the database daemon
restart service ftpd <b>Replaces:</b> service ftpd restart	restart service ftpd	Restart the FTP traffic scanning daemon
restart service httpd <b>Replaces:</b> service httpd restart	restart service httpd	Restart the HTTP traffic scanning daemon
restart service iwss_daemons <b>Replaces:</b> restart iwss_daemons	restart service iwss_daemons	Restart all IWSVA services
restart service logtodb <b>Replaces:</b> service logtodb restart	restart service logtodb	Restart the daemon that saves logs to database
restart service maild <b>Replaces:</b> service maild restart	restart service maild	Restart the email notification daemon

TABLE 12-1. Command Line Interface Commands (Continued)

COMMAND	SYNTAX	DESCRIPTION
restart service metric_mgmt <b>Replaces:</b> service metric_mgmt restart	restart service metric_mgmt	Restart the metric management daemon
restart service ssh <b>Note:</b> This is a new command.	restart service ssh	Restart the SSH daemon
restart service svcmonitor <b>Replaces:</b> service svcmonitor restart	restart service svcmonitor	Restart the monitor daemon
restart service tmcmagent <b>Replaces:</b> service tmcmagent restart	restart service tmcmagent	Restart the TCM agent
restart service tmsyslog <b>Replaces:</b> service tmsyslog restart	restart service tmsyslog	Restart the syslog daemon
restart service wccpd <b>Replaces:</b> service wccpd restart	restart service wccpd	Restart the WCCP daemon
restart service webui <b>Replaces:</b> service webui restart	restart service webui	Restart the tomcat daemon

**TABLE 12-1. Command Line Interface Commands (Continued)**

<b>COMMAND</b>	<b>SYNTAX</b>	<b>DESCRIPTION</b>
show kernel iostat <b>Replaces:</b> show statistic io	show kernel iostat	Display Central Processing Unit (CPU) statistics and input/output statistics for devices, partitions and network file systems (NFS)
show kernel messages	show kernel messages	Display kernel messages
show kernel modules	show kernel modules	Display modules loaded in the kernel
show kernel parameters	show kernel parameters	Display running kernel parameters
show memory statistics <b>Replaces:</b> show statistic memory	show memory statistics	Display memory statistics
show module config all <b>Replaces:</b> show config all	show module config all	View the all the config files
show module config database <b>Replaces:</b> show config db	show module config database	View the database config files
show module config file intscan <b>Replaces:</b> show file <intscan>	show module config file intscan	View the intscan config file



TABLE 12-1. Command Line Interface Commands (Continued)

COMMAND	SYNTAX	DESCRIPTION
show module config file IWSSPIJavascan <b>Replaces:</b> show file <IWSSPIJavascan >	show module config file IWSSPIJavascan	View the IWSSPIJavascan config file
show module config file IWSSPIProtocolFtp <b>Replaces:</b> show file < IWSSPIProtocolFtp>	show module config file IWSSPIProtocolFtp	View the IWSSPIProtocolFtp config file.
show module config file IWSSPIProtocolHttpPro xy <b>Replaces:</b> show file < IWSSPIProtocolHttpPro xy>	show module config file IWSSPIProtocolHttpPro xy	View the IWSSPIProtocolHttpPro xy config file
show module config file IWSSPIProtocollcap <b>Replaces:</b> show file < IWSSPIProtocollcap >	show module config file IWSSPIProtocollcap	View the IWSSPIProtocollcap config file
show module config file IWSSPIScanVsapi <b>Replaces:</b> show file < IWSSPIScanVsapi >	show module config file IWSSPIScanVsapi	View the IWSSPIScanVsapi config file

**TABLE 12-1. Command Line Interface Commands (Continued)**

<b>COMMAND</b>	<b>SYNTAX</b>	<b>DESCRIPTION</b>
show module config file IWSSPSigScan <b>Replaces:</b> show file < IWSSPSigScan>	show module config file IWSSPSigScan	View the IWSSPSigScan config file
show module config file IWSSPUrlFilter	show module config file IWSSPUrlFilter	View the IWSSPUrlFilter config file
show module database backup <b>Replaces:</b> show db backup	show module database backup	Display database backups
show module database password <b>Replaces:</b> show db password	show module database password	Display the database password
show module database settings <b>Replaces:</b> show db settings	show module database settings	Display the configuration of the database
show module database size <b>Replaces:</b> show db size	show module database size	Display the size of IWSVA database
show module http x-forwarded-for	show module http x-forwarded-for	Display the configuration of the XFF HTTP header module

**TABLE 12-1. Command Line Interface Commands (Continued)**

<b>COMMAND</b>	<b>SYNTAX</b>	<b>DESCRIPTION</b>
show module ldap groupcache interval <b>Replaces:</b> show ldap groupcache interval	show module ldap groupcache interval	Display IWSVA LDAP user group membership cache interval

**TABLE 12-1. Command Line Interface Commands (Continued)**

<b>COMMAND</b>	<b>SYNTAX</b>	<b>DESCRIPTION</b>
show module ldap ipuser_cache <b>Replaces:</b> show ldap ipuser_cache	show module ldap ipuser_cache	Display the configuration of IWSVA LDAP IP user cache.  Client IP cache associates a client IP address with a user who recently authenticated from that same IP address. Any request originating from the same IP address as a previously authenticated request will be attributed to that user, provided the new request is issued within a configurable window of time (15 minutes by default for HTTP, 90 minutes for ICAP) from that authentication. The caveat is that client IP addresses seen by IWSVA must be unique to a user within that time period; thus this cache is not useful in environments where there is a proxy server or source NAT between the clients and IWSVA, or where DHCP frequently reassigns client IPs.

**TABLE 12-1. Command Line Interface Commands (Continued)**

<b>COMMAND</b>	<b>SYNTAX</b>	<b>DESCRIPTION</b>
show module ldap ipuser_cache interval <b>Replaces:</b> show ldap ipuser_cache interval	show module ldap ipuser_cache interval	Display IWSVA LDAP IP user cache interval
show module ldap www-auth port <b>Replaces:</b> show www-auth port	show module ldap www-auth port	Display the authentication port
show module log admin <b>Replaces:</b> show log admin [log_suffix]	show module log admin [log_suffix]	View the admin log file The log_suffix format is date.revision. Example: 20120518.0001  To view the admin log, use: show module log admin 20120518.0001
show module log ftp <b>Replaces:</b> show log ftp [log_suffix]	show module log ftp [log_suffix]	View the ftp log file The log_suffix format is date.revision Exam- ple:20120518.0001  To view the ftp log, use: show module log ftp 20120518.0001

**TABLE 12-1. Command Line Interface Commands (Continued)**

<b>COMMAND</b>	<b>SYNTAX</b>	<b>DESCRIPTION</b>
show module log http <b>Replaces:</b> show log http [log_suffix]	show module log http [log_suffix]	View the http log file The log_suffix format is date.revision Example:20120518.0001 To view the ftp log, use: show module log ftp 20120518.0001
show module log mail <b>Replaces:</b> show log mail [log_suffix]	show module log mail [log_suffix]	View the mail log file The log_suffix format is data.revision Example:20120518.0001 To view the mail log, use: show module log mail 20120518.0001
show module log postgres <b>Replaces:</b> show log postgres  show module log tmudump <b>Replaces:</b> show log tmudump	show module log postgres  show module log tmudump	View the postgres log  View the tmudump log file
show module log update <b>Replaces:</b> show log update [log_suffix]	show module log update [log_suffix]	View the update log file log_suffix LOGSUFFIX [log_suffix] []

TABLE 12-1. Command Line Interface Commands (Continued)

COMMAND	SYNTAX	DESCRIPTION
show module metrics ftp <b>Replaces:</b> show metrics ftp	show module metrics ftp	Display IWSVA ftp performance metrics
show module metrics http <b>Replaces:</b> show metrics http	show module metrics http	Display IWSVA http performance metrics
show module ntp schedule <b>Replaces:</b> show ntp schedule	show module ntp schedule	Display the scheduled NTP server configuration
show module webui port <b>Replaces:</b> show webserver port	show module webui port	Display Web server port settings
show network neighbour <b>Replaces:</b> show network arp	show network neighbour [dest]	Display system arp tables <i>dest</i> ADDRESS Remote IP address to arp
show network bonding <bonding name>	show network bonding <bonding name>	Display bonding settings If <bonding name> is missing, all bonding settings display. If <bonding name> is specified, specified bonding settings display.

**TABLE 12-1. Command Line Interface Commands (Continued)**

<b>COMMAND</b>	<b>SYNTAX</b>	<b>DESCRIPTION</b>
show network bridge redirect ftpports <b>Replaces:</b> show redirect ftpports	show network bridge redirect ftpports	Display the FTP redirection port numbers
show network bridge redirect httpports <b>Replaces:</b> show redirect httpports	show network bridge redirect httpports	Display the HTTP redirection port numbers
show network bridge redirect httpsports <b>Replaces:</b> show redirect httpsports	show network bridge redirect httpsports	Display the HTTPS redirection port numbers
show network bridge stp <b>Note:</b> This is a new command.	show network bridge stp	Display the bridge STP settings
show network capture <b>Replaces:</b> show capture [filename]	show network capture [filename]	Display packets captures <i>filename</i> <u>STRING</u> [filename] []



TABLE 12-1. Command Line Interface Commands (Continued)

COMMAND	SYNTAX	DESCRIPTION
show network connections <all/listening> <all/tcp/udp>  <b>Replaces the following commands:</b> show connections show daemons  <b>Note:</b> Additional parameters available in new command.	show network connections <all/listening> <all/tcp/udp>	Display system connections or daemons.  For example, execute “show network connections listing” to display which daemons are running.
show network conntrack  <b>Replaces:</b> show conntrack	show network conntrack	Display state tracked connections
show network conntrack expect  <b>Replaces:</b> show conntrack expect	show network conntrack expect	Display state expected connections
show network data interface  <b>Replaces:</b> show ip address	show network data interface  Interface: eth0  IPv4 address/mask: 10.168.10.78/255.255.255.0  IPv6 address/prefix: 2001:20::1/64  Type: static	Display network address

**TABLE 12-1. Command Line Interface Commands (Continued)**

COMMAND	SYNTAX	DESCRIPTION
show network dns <b>Replaces:</b> show ip dns	show network dns	Display network dns servers
show network ethernet <b>Replaces:</b> show ethernet <ethname>	show network ethernet <ethname>	Display Ethernet card settings  <i>ethname</i> <u>IFNAME</u> Interface name
show network firewall filter <b>Replaces:</b> show firewall filter	show firewall filter  The IPv6 firewall rules are appended to the IPv4 firewall rules.	Display firewall filter
show network firewall nat <b>Replaces:</b> show firewall nat	show firewall nat	Display firewall NAT
show network gateway ipv4/ipv6 <b>Replaces:</b> show ip gateway	show network gateway  IPv4 gateway: 10.168.10.254  IPv6 gateway: 2001:10::1	Display ipv4/ipv6 network gateways
show network hostname <b>Replaces:</b> show hostname	show network hostname	Display network hostname
show network interfaces <b>Replaces:</b> show interfaces	show network interfaces	Display network interface information

TABLE 12-1. Command Line Interface Commands (Continued)

COMMAND	SYNTAX	DESCRIPTION
show network interfaces status Replaces: <b>Note:</b> This is a new command.	show network interfaces status	Display the link status of the network card
show network interfaces status once <b>Note:</b> This is a new command.	show network interfaces status once	Display the link status of the network card once
show network interfaces statistic <b>Note:</b> This is a new command.	show network interfaces statistic	Display the link status of the network card
show network lanbypass <b>Note:</b> This is a new command.	show network lanbypass	Displays the current configuration status of LAN-bypass function  If LAN-bypass used, it would show one of the following states: on / off / auto.

**TABLE 12-1. Command Line Interface Commands (Continued)**

COMMAND	SYNTAX	DESCRIPTION
show network mgmt interface  <b>Replaces:</b> show mgmt ip address show mgmt status	show network mgmt interface  Management interface: enable  Interface: eth1  IPv4 address/mask: 10.168.20.78/255.255.255.0  IPv6 address/prefix: 2001:10::1/64  Type: static	Display the status and address information
show network ping  <b>Replaces:</b> show ping show ping mgmt	show network ping	Display data and management status
show network portgroup	show network portgroup	Display current port group settings
show network route ipv4/ipv6  <b>Replaces:</b> show ip route	show network route ipv4/ipv6  (routes displayed as follows):	Display an IPv4/IPv6 network routing table
<pre> enable# show network route Kernel IP routing table Destination Gateway Genmask Flags Metric Ref Use Iface 10.168.10.0 0.0.0.0 255.255.255.0 U 0 0 0 eth0 169.254.0.0 0.0.0.0 255.255.0.0 U 0 0 0 eth1 0.0.0.0 10.168.10.254 0.0.0.0 UG 0 0 0 eth0 Kernel IPv6 routing table Destination Next Hop Flags Metric Ref Use Iface fe80::/64 * U 256 0 0 eth0 */0 * UGDA 1024 1 0 eth0 localhost6.localdomain6/128 * U 0 3 3 lo 2001::20c:29ff:fe73:296b/128 * U 0 0 1 lo fe80::20c:29ff:fe73:296b/128 * U 0 2 1 lo ff02::1/128 UC 0 1 0 eth0 ff00::/8 * U 256 0 0 eth0           </pre>		

TABLE 12-1. Command Line Interface Commands (Continued)

COMMAND	SYNTAX	DESCRIPTION
show network sockets <b>Replaces:</b> show open sockets	show network sockets	Display open network socket statistics
show process library	show process library <pid>	A library call tracer <i>pid</i> <u>UINT</u> <pid>
show process stack	show process stack <pid>	Print a stack trace of a running process <i>pid</i> <u>UINT</u> <pid>
show process [target]	show process [target]	Display process information <i>target</i> <u>STRING</u> [optional name/ID with wildcard support] []
show process top	show process top	Display information about running processes
show process trace	show process trace <pid>	Trace system calls and signals <i>pid</i> <u>UINT</u> <pid>
show service ssh <b>Replaces:</b> show ssh	show service ssh	Show status of SSH service

**TABLE 12-1. Command Line Interface Commands (Continued)**

COMMAND	SYNTAX	DESCRIPTION
show storage partition <b>Replaces:</b> show disk partition [partition] show disk partition readable [partition]	show storage partition [partition]	Report file system usage in readable format only <i>partition</i> <u>STRING</u> [optional partition] []
show storage space <b>Replaces:</b> show disk space [target] show disk space readable [target]	show disk space [target]	Report file space usage in readable format only <i>target</i> <u>STRING</u> [optional directory or filename] [/]
show storage statistic <b>Replaces:</b> show statistic disk	show storage statistic	Display disk statistics
show system configuration	show system configuration	Display IPv4 and IPv6 summary information for the running configuration
show system configuration [-verbose] <b>Replaces:</b> show running configuration -verbose	show system configuration [-verbose]	Display detailed information of running configuration
show system date Replaces: show date	show system date	Display current date/time

TABLE 12-1. Command Line Interface Commands (Continued)

COMMAND	SYNTAX	DESCRIPTION
show system ha <b>Note:</b> This is a new command.	show system ha	Display HA information, such as: Cluster name, Description, HA mode, Deployment mode, Cluster IP address(es) (IPv4 and/or IPv6) - should be configured as 172.16.2.200/2001:10::1 for example, Preemption, Member list, Role, Localhost, Hostname, IP address, Weight
show system hwmonitor <b>Note:</b> This is a new command.	show system hwmonitor	Display hardware monitoring information.
show system hwmonitor interval <b>Note:</b> This is a new command.	show system hwmonitor interval	Show current polling interval value.
show system hwmonitor sel <b>Note:</b> This is a new command.	show system hwmonitor sel	Shows the hardware event log information as a base for sending SNMP traps.
show system hwmonitor sensor <b>Note:</b> This is a new command.	show system hwmonitor sensor	Shows all the information gathered from sensors.
show system keyboard	show system keyboard	Display default keyboard table

**TABLE 12-1. Command Line Interface Commands (Continued)**

<b>COMMAND</b>	<b>SYNTAX</b>	<b>DESCRIPTION</b>
show system openfiles <b>Replaces:</b> show open files [target]	show system openfiles [target]	Display open files <i>target</i> <u>STRING</u> [optional directory or filename] []
show system timezone <b>Replaces:</b> show timezone	show timezone	Display the timezone on IWSVA
show system uptime <b>Replaces:</b> show uptime	show system uptime	Show how long the system has been running
show system version <b>Replaces:</b> show version	show system version	Display IWSVA version
shutdown	shutdown [time]	Shutdown this machine after a specified delay or immediately <i>time</i> <u>UINT</u> Time in minutes to shutdown this machine [0]
start service database <b>Replaces:</b> service database start	start service database	Start the database daemon
start service ftpd <b>Replaces:</b> service ftpd start	start service ftpd	Start the FTP traffic scanning daemon



**TABLE 12-1. Command Line Interface Commands (Continued)**

<b>COMMAND</b>	<b>SYNTAX</b>	<b>DESCRIPTION</b>
start service httpd <b>Replaces:</b> service httpd start	start service httpd	Start the HTTP traffic scanning daemon
start service logtodb <b>Replaces:</b> service logtodb start	start service logtodb	Start the daemon that saves logs to database
start service maild <b>Replaces:</b> service maild start	start service maild start	Start the email notification daemon
start service metric_mgmt <b>Replaces:</b> service metric_mgmt start	start service metric_mgmt	Start the metric management daemon
start service ssh <b>Replaces:</b> enable ssh	start service ssh	Enable the sshd daemon
start service svcmonitor <b>Replaces:</b> service svcmonitor start	start service svcmonitor	Start the monitor daemon
start service tmcmagent <b>Replaces:</b> service tmcmagent start	start service tmcmagent	Start the TCM agent

**TABLE 12-1. Command Line Interface Commands (Continued)**

<b>COMMAND</b>	<b>SYNTAX</b>	<b>DESCRIPTION</b>
start service tmsyslog <b>Replaces:</b> service tmsyslog start	start service tmsyslog	Start the syslog daemon
start service wccpd <b>Replaces:</b> service wccpd start	start service wccpd	Start the WCCP daemon
start service webui <b>Replaces:</b> service webui start	start service webui	Start the tomcat daemon
start shell <b>Replaces:</b> admin shell	start shell	Administrative shell access
start task database backup <b>Replaces:</b> admin db backup	start task database backup	Back up your database
start task database reindex <b>Replaces:</b> admin db reindex	start task database reindex	Reindex the IWSVA database
start task database restore <b>Replaces:</b> admin db restore [filename]	start task database restore [filename]	Restore your database from a backup

TABLE 12-1. Command Line Interface Commands (Continued)

COMMAND	SYNTAX	DESCRIPTION
start task database truncate <b>Replaces:</b> admin db truncate <DATE_FIELD>	start task database truncate <DATE_FIELD>	Truncate the IWSVA database
start task database vacuum <b>Replaces:</b> admin db vacuum	start task database vacuum	Vacuum the IWSVA database
<p><b>Note:</b> If the administrator finds that database may not be fully vacuumed, tune the “max_fsm_pages” parameter in the <code>postgresql.conf</code> configuration file found at <code>/var/iwss/postgres/pgdata/</code>.</p>		
start task capture interface <b>Replaces:</b> capture interface <interface> [-h host] [-p port]	start task capture interface <interface> [-h host] [-p port]	Capture network interface traffic <i>interface</i> IFNAME interface to capture packets <i>-h</i> host IP_ADDR filter by IP address <i>-p</i> port UINT filter by port number
start task monitor ftp <b>Replaces:</b> monitor ftp	start task monitor ftp	Monitor the FTP log
start task monitor http <b>Replaces:</b> monitor http	start task monitor http	Monitor the HTTP log

**TABLE 12-1. Command Line Interface Commands (Continued)**

<b>COMMAND</b>	<b>SYNTAX</b>	<b>DESCRIPTION</b>
stop process	stop process <pid>	Stop a running process <i>pid</i> <u>UINT</u> <pid>
stop process core	stop process core <pid>	Stop a running process and generate a core file <i>pid</i> <u>UINT</u> <pid>
stop service database <b>Replaces:</b> service <database> stop	stop service database	Stop the database daemon
stop service ftpd <b>Replaces:</b> service <ftpd> stop	stop service ftpd	Stop the FTP traffic daemon
stop service httpd <b>Replaces:</b> service httpd stop	stop service httpd	Stop the HTTP traffic daemon
stop service logtodb <b>Replaces:</b> service logtodb stop	stop service logtodb	Stop the daemon that saves logs to database
stop service maild <b>Replaces:</b> service maild stop	stop service maild	Stop the email notification daemon
stop service metric_mgmt <b>Replaces:</b> service metric_mgmt stop	stop service metric_mgmt	Stop the metric management daemon

TABLE 12-1. Command Line Interface Commands (Continued)

COMMAND	SYNTAX	DESCRIPTION
stop service ssh <b>Replaces:</b> disable ssh	stop service ssh	Disable the sshd daemon
stop service svcmonitor <b>Replaces:</b> service svcmonitor stop	stop service svcmonitor	Stop the monitor daemon
stop service tcmagent <b>Replaces:</b> service tcmagent stop	service stop tcmagent	Stop the TCM agent
stop service tmsyslog <b>Replaces:</b> service tmsyslog stop	stop service tmsyslog	Stop the syslog daemon
stop service wccpd <b>Replaces:</b> service wccpd stop	stop service wccpd	Stop the WCCP daemon
stop service webui <b>Replaces:</b> service webui stop	stop service webui	Stop the tomcat daemon
traceroute	traceroute [-h hops] <dest> [-n]	TraceRoute -h hops <u>UINT</u> Specify maximum number of hops dest <u>ADDRESS</u> Remote system to trace -n <u>DASHN</u> Do not resolve hostname []

**TABLE 12-1. Command Line Interface Commands (Continued)**

<b>COMMAND</b>	<b>SYNTAX</b>	<b>DESCRIPTION</b>
traceroute6	traceroute6 <IPv6 address>	TraceRoute6 <i>-h hops</i> <u>UINT</u> Specify maximum number of hops <i>dest ADDRESS</i> Remote IPv6 host to trace <i>-n DASHN</i> Do not resolve hostname []
wget	wget <url> <path>	Download file through HTTP/FTP protocols <i>url</i> <u>STRING</u> [http://username:password@hostname/path] <i>path</i> <u>FILENAME</u> The local path to download file

# Chapter 13

## Reports, Logs, and Notifications

This chapter describes how administrators can get timely information about their gateway security through InterScan Web Security Virtual Appliance (IWSVA) reports, logs, and notifications.

Topics in this chapter include the following:

- [Introduction to Reports on page 13-2](#)
- [Types of Reports on page 13-3](#)
- [Report Settings on page 13-2](#)
- [Generating Reports on page 13-5](#)
- [Introduction to Logs on page 13-9](#)
- [Syslog Configuration on page 13-15](#)
- [Introduction to Notifications on page 13-16](#)
- [Configuring C&C Contact Callback Notifications on page 13-25](#)
- [Enabling MAC Address Client Identification on page 13-42](#)

## Introduction to Reports

IWSVA can generate reports about virus and malicious code detections, files blocked, and URLs accessed. You can use this information about IWSVA program events to help optimize program settings and fine tune your organization's security policies.

You can configure and customize reports. For example, IWSVA allows you to generate reports for all or specific user(s), all or specific group(s), either on demand (in real time) or on a scheduled basis.

To allow you to share the selected report information with those who need it, IWSVA can send the generated report through email as file attachments.

## Report Information

Enter the desired report name and a short description of the report. Enable the report by selecting either Yes or No.

## Report Settings

When generating a report template you need to specify the following information:

- Generate the report based on a specific schedule.
- Generate the report based on a specific time period.
- Indicate the type of output (PDF, HTML, or CSV file).
- Indicate the number of reports to save and keep.

---

**Note:** For Report Settings, time is measured as follows:  
Last 1 Day: From the start of the day 00:00 to day -1

---



## Email This Report

For all reports,

Select Email This Report and complete the settings:

- Enter the “From” email address.
- Enter the “Recipients” email address to send a copy of the report to a specific person or to an email distribution list after the report has been generated.
- Enter the intended message.
- “Enable” the report to be sent as an attachment.
- Indicate your selection of notification in the event of a message delivery failure.

## Report By (Users and Groups)

Select the user(s) and or group(s) for which you want to generate a report. Options include:

- **All users:** All clients accessing the Internet through IWSVA
- **Specific user(s):** Clients with specific IP addresses, host names, or LDAP directory entries
- **All groups:** All groups in the LDAP directory; if using the IP address or host name identification method, then “All groups” is equivalent to “All users”
- **Specific group(s):** Either specified LDAP groups or a range of IP addresses

When generating reports for specific users or groups, the user selection method is determined by the method configured under **Administration > IWSVA**

**Configuration > User Identification | User Identification** tab. For more information about user identification, see [Configuring the User Identification Method starting on page 7-6](#).

## Types of Reports

IWSVA can generate bar or table chart graphs that represent the following categories of reports:

- Internet Security — See reports that itemize the following top n Internet security detections:
  - malware/spyware detection counts

- botnet detection
- advanced threat detection
- custom defense APT blocking
- malicious sites blocked
- users blocked by malware/spyware
- users blocked by malicious sites
- groups blocked by malware/spyware
- groups blocked by malicious sites
- malicious sites blocked by date
- malware/spyware detections by date
- malware/spyware detection trend
- C&C callback attempt counts by date
- C&C callback IPs/domains
- users/hosts detected by C&C callback attempts
- groups detected by C&C callback attempts
- Internet Access — See reports itemizing the following top n Internet Access detections:
  - applications visited
  - URL categories visited
  - sites visited
  - users by requests
  - groups by requests
  - URL categories sorted by browse times
  - sites visited by browse times
  - Top N users by browse time
- Bandwidth — See reports itemizing the following top n bandwidth detections:
  - URL categories by bandwidth
  - applications by bandwidth
  - users by bandwidth

- groups by bandwidth
- sites by traffic
- Policy Enforcement — See reports itemizing the following top n policy enforcement detections:
  - URL categories blocked
  - applications blocked
  - users enforced
  - groups enforced
  - sites blocked
- Data Security — See reports itemizing the following top n data security detections:
  - DLP templates blocked by requests
  - blocked users
  - blocked groups
- Custom Report — Include defined Log Favorites to be reported. See [Report Types](#) on page 13-7 for more information.

## Generating Reports

As with the behavior of IPv4, reports can be generated by a specific IPv6 user or an IPv6 group of users. The selected user or group of users page also supports IPv6 addresses or ranges.

Reports can be generated in CSV, PDF, or HTML formats for both IPv4 and IPv6 users without encountering layout issues. As with the behavior of IPv4, when generating user-related reports, all IPv6 users can be accounted for in the report without encountering layout issues.

## Configuring Reports

IWSVA enables you to generate reports for either all or a subset of the clients accessing the Internet. You can save the generated report in PDF, HTML, or CVS format.

**To configure reports:**

1. Click **Reports** in the main menu.
2. Click **Add** to add a new report template.
3. Enter a name and description for the report template. When you are ready for the template to take effect, click **Yes** to enable it.
4. Under **Report Settings**, select a schedule for the report (either **Once Now**, **Once in the Future**, **Every Day**, **Every Week**, or **Every Month**), and then select the **Report Period**. Click **Custom Time Range** to generate a report in a given time range, and then select the **From** and **To** dates.
5. Select the **Report Output**.
6. Configure the email recipients, subject, and message along with the optional settings.
7. Under **Report By**, select the users for which the report is generated—either **All Users**, **Specific Users/Groups** - IPv6 addresses can also be defined when choosing Specific user(s), **All groups**, or **Specific group(s)**. For more information about running reports for specific users or groups, see [To select specific users or group\(s\)](#).
8. Under **Report Types**, select the report type(s) and enter the desired report record number(s).

---

**Note:** IWSVA groups multiple report parameters into a single report, with each report parameter having its own section.

---

9. Select the chart type (Bar or Table) from the menu.
10. Click **Save Report**.

The following table provides information about the parameters that can comprise a report:

**TABLE 13-1. Report Parameter Availability Depends on the Report Type**

REPORT BY	REPORT PARAMETERS INCLUDED
All users	Includes all listed report parameters except for "Individual user reports"

**TABLE 13-1. Report Parameter Availability Depends on the Report Type (Continued)**

REPORT BY	REPORT PARAMETERS INCLUDED
Specific Users/Groups	Includes only the “Individual user reports” parameters
* For Web Reputation (including anti-pharming and anti-phishing), blocked sites appear in these reports. But to find a blocked site, the information is only in “Top N Malicious Sites Blocked.”	

**To select specific users or group(s):**

1. Click **Reports** in the main menu.
2. Under **Report by**, select **Specific Users / Groups**, and then click **Select**.  
The **Select Users / Groups** pop-up screen opens according to the configured user identification method (**Administration > IWSVA Configuration > User Identification | User Identification**).
3. Type the IP host name or address range (or search for a group name in your LDAP directory if using the “User/group name authentication” identification method).
4. Type specific users or groups and click **Search**.
5. Click **Add**.
6. After adding all the groups, click **Save**.

## Report Types

For each report parameter, you can specify how many records you want to include in reports. For each report type, the default includes records like: the top number of users, URLs, categories, and so on, for each report type. Specifying a very large number, such as 99, will affect report size and generation time.

The Top Categories (weighted) reporting parameter provides information about URL categories, even ones that are blocked or monitored. Also, this parameter provides the number of requests of every URL category and URL visited. This information can help you determine which URL category needs to be blocked or monitored for different Internet groups.

For the reporting parameters, the following conditions apply:

- The user can be an address, username, or a host name.
- For HTTP, URL addresses include the whole address, not just the top-level domain. For HTTPS, URL addresses include only the top-level domain.
- Content is listed by most frequently visited URLs specified by the user, and sorted by number of visits.

Management can review this activity and then determine if requests are permissible.

For custom reports, you can include saved or “favorited” logs to a customized report. Custom report uses the time range already set in the report template. Other settings are the same as those configured in the favorited logs.

## Scheduling Reports

You can configure IWSVA to generate scheduled reports on a once now, once in the future, daily, weekly, or monthly basis.

### To configure scheduled reports:

1. Create a new report in **Reports** from the main menu.
2. Click **Add** or a report name to edit it.
3. Enter a report name for the new report. Under **Report Settings** set the time and/or date to generate the scheduled report.
4. Select **Email** and the attachment format, and type the email address(es) to which IWSVA should send the generated report as a file attachment. You must also enter the **From** and **Subject** fields. Separate multiple email addresses with commas.

---

**Note:** The SMTP server related settings are in **Notifications > Email Settings**.

---

5. Click **Save**.

**To delete a scheduled report:**

1. Click **Reports** on the main menu.
2. Select the report template to remove and then click **Delete**.

**Saved Scheduled Reports**

When a scheduled report is generated, IWSVA sends the report to specified recipients and saves a copy to the database. You can view or download the saved report under **Reports** and click the **Saved Reports** tab. You can configure the number of saved reports IWSVA is to store in the database.

**Introduction to Logs**

The IWSVA database stores all log data, but log data can also be stored in text log files for backward compatibility with previous IWSVA versions or used with an external reporting tool. Storing the log data in text log files provides redundancy to verify that the database is properly updated. Trend Micro recommends using the database as the only storage location for log data.

---

**Note:** For Log Analysis, time is measured as follows:  
Last 1 Hour: From current time to start of this hour.  
Last 1 Day: From current time to start of this hour - 23 hours

---

Log are categorized by log type, and are mapped or grouped as follows:

- *Bandwidth*
- *Policy Enforcement*
- *Internet Access*
- *Internet Security*
- *Data Security*
- *Access Control*

## Bandwidth

Each log display can utilize any one of the following filters:

- Incoming traffic
- Outgoing traffic
- All traffic
- User Name
- Device Name
- Client IP
- App ID
- Policy Name

Continue sorting with time range filters: Today, last 1 hour, last 12 hours, last 1 day, last seven days, or a customized time range. Set the top number of instances you would like to show from Top 5 to Top 20. Choose the output in which you would like to display your results; bar, line, pie chart and so on.

## Policy Enforcement

Each log display can utilize any one of the following filters:

- Action
- Message Type
- Device Name
- Client IP
- Channel
- App ID
- Policy Name
- User Name
- Rule Name
- URL Category



Continue sorting with time range filters: Today, last 1 hour, last 12 hours, last 1 day, last seven days, or a customized time range. Set the top number of instances you would like to show from Top 5 to Top 20. Choose the output in which you would like to display your results; bar, line, pie chart and so on.

## Internet Access

Each log display can utilize any one of the following filters:

- Domain
- Device Name
- Client IP
- User Name
- URL Category

Continue sorting with time range filters: Today, last 1 hour, last 12 hours, last 1 day, last seven days, or a customized time range. Set the top number of instances you would like to show from Top 5 to Top 20. Choose the output in which you would like to display your results; bar, line, pie chart and so on.

## Internet Security

Each log display can utilize any one of the following filters:

- Action
- Message Type
- Malware Name
- Device Name
- Client IP
- Channel
- Policy Name
- User Name

Continue sorting with time range filters: Today, last 1 hour, last 12 hours, last 1 day, last seven days, or a customized time range. Set the top number of instances you would like to show from Top 5 to Top 20. Choose the output in which you would like to display your results; bar, line, pie chart and so on.

## Data Security

Each log display can utilize any one of the following filters:

- Action
- Device Name
- Client IP
- Channel
- Policy Name
- User Name
- Rule Name

Continue sorting with time range filters: Today, last 1 hour, last 12 hours, last 1 day, last seven days, or a customized time range. Set the top number of instances you would like to show from Top 5 to Top 20. Choose the output in which you would like to display your results; bar, line, pie chart and so on.

## Access Control

Each log display can utilize any one of the following filters:

- Action
- Message Type
- Device Name
- Client IP
- Channel
- Policy Name
- User Name

Continue sorting with time range filters: Today, last 1 hour, last 12 hours, last 1 day, last seven days, or a customized time range. Set the top number of instances you would like to show from Top 5 to Top 20. Choose the output in which you would like to display your results; bar, line, pie chart and so on.

## Options for Recording Data

Configure reporting log options in the IWSVA Web console under **Logs > Log Settings** (see [Log Settings starting on page 13-13](#) for more information).

## Querying and Viewing Logs

The IWSVA Web console provides tools to query log files.

- **Log Search** - A search box for each individual facet is provided in IWSVA. It includes an “autocomplete” function that reveals possible results with the search term highlighted.
- **Time Zone** - All logs are displayed within the same time zone that was originally configured in your client.
- **Pie Charts** - Pie charts now include an “other” category. For example, if the user chooses to view the top five malware instances, each malware will have a wedge of the chart and an “other” wedge will appear that includes all malware outside the top five. (If there are only five instances of malware, then the “other” wedge does not appear.)
- **Add to Favorites** - Add to Favorites enable you to store the frequently-used log settings to the Log Analysis Favorites location. “Favorited” logs can be found at **Logs > Favorites**.

---

**Note:** Line and Pie charts both include “drill down” capabilities where you can click the section of the chart you are interested in learning more about and then view detailed information about that section.

---

## Log Settings

From the **Log Settings** screen, you can configure:

- Global Log Settings such as the length of time to store logs and the maximum log size to store.
- Global Log Filtering by user names and domains using filters for bandwidth, policy enforcement, Internet access, Internet security, data security, and access control.

- Anonymous Logging can be enabled or disabled.
- Syslog Servers to use for additional log storage based on type and priority.

**To configure Global Log Settings:**

1. Go to **Logs > Log Settings**.
2. Under Global Log Settings, enter the number of days to retain logs before purging.

---

**Note:** Setting the purge value for less than 62 could prevent the generation of monthly reports. Setting the value to more than 62 days could cause the accumulated data to become large enough to affect performance.

---

3. Set the maximum file size of log data to be stored. If log data exceeds the size specified, older log data will be deleted automatically and replaced by newer data. To help free storage space, log data older than the specified days will also be deleted.
4. If you would like all logs forwarded to a syslog server, add the IP address and port number of the server where the syslogs can be forwarded.

## Global Log Filtering

Use global log filtering when you want specific data omitted from your logs. For example, use this filter in a case where you do not need to log Internet Access logs for user John Smith or Bandwidth usage for users who visit [www.google.com](http://www.google.com).

## Anonymous Logging

Some European countries have laws stating that user names cannot be recorded in logs. After enabling this feature, user names within the log will be recorded as MD5 values instead of the actual user names.

## Exporting Log and Report Data as CSV Files

When viewing your log query or a real-time report, IWSVA supports exporting log data to a CSV file in order to view and analyze the data in other applications. Click the table icon and then **Export CSV file** and then download the file from the IWSVA server.

## Exporting Report Data as PDF Files

In addition to the CSV export feature, IWSVA also allows you to export report data (up to 1000 raw logs) as PDF files that can be viewed using a PDF-reader application in any platform. Click **PDF** and follow the on-screen prompt to download the file from the IWSVA server.

## Syslog Configuration

With syslog server support, IWSVA can send logs to external syslog servers. You can configure up to a maximum of four syslog servers and specify the type or priority level of the logs to send to each syslog server.

### To configure a syslog server:

1. Click **Logs >Log Settings > Syslog Server** in the main menu.
2. Click **Add**.
3. For **Syslog Server Settings**:
  - a. Select **Enable Syslog** to allow IWSVA to send logs to this syslog server
  - b. Specify the **Server name/IP address**. IWSVA supports the sending of syslog messages to both IPv4 and IPv6 hosts. The Web UI can accept both IPv6 host names and addresses similarly to the behavior of IPv4.
  - c. Specify the **UDP Port #** (the default is 514)

4. Under **Save the Following Logs**, specify the logs to send. You can select to send events to the syslog server by either the log type or the syslog priority level.
  - Click **By log type** and select the type(s) of logs. Or,
  - Click **By syslog priority level** and select the level(s)
5. Click **Save**.

## Introduction to Notifications

Notifications can be issued in response to scanning, blocking, alerting, and program update events. There are two types of notifications—administrator notifications and user notifications, described as follows:

- **Administrator notifications** provide information about HTTP/HTTPS scanning, HTTP/HTTPS file blocking, FTP blocked file types, FTP scanning, threshold alerts, restricted tunnel traffic, High Availability events, and Applets/ActiveX security events, as well as pattern file and scan engine updates. IWSVA sends administrator notifications through email to addresses that you configure in the “**Send notifications to...**” screen.
- **User notifications** provide information about HTTPS access errors, HTTPS certificate warnings, HTTP/HTTPS scans, HTTP/HTTPS file blockages, FTP scans, URL blockages, FTP blocked file types, High Availability events, and Applets/ActiveX scanning events. IWSVA presents user notifications in the client’s browser or FTP client in lieu of the prohibited Web page or file that the client is trying to view or download.

The messages presented in both the administrator and user notifications are configurable and can include “tokens” or variables to customize notification messages with information about the event. In addition, user notification messages support HTML tags to customize the appearance of the message and provide links to other resources, such as security policy documents hosted on your intranet.

---

**Note:** As with IPv4, all tokens can be applied to IPv6 access, including:  
%N - user name  
%c: IP address:port after **Error! Hyperlink reference not valid** (for HTTPS decryption). For IPv6, it should be https://[IPv6 address]:port. IPv4 still retains https://IPv4 address:port.

---

## Notification Email Settings

IWSVA sends administrator notifications to email addresses that you specify. The administrator enters email settings when installing IWSVA and when running the setup program, but email settings can also be modified post-installation on the Web console's **Email Settings** screen.

### To configure email settings for administrator notifications:

1. Click **Notifications** in the main menu.
2. In the **Notifications** screen, click **Send notification to**.
3. Type the email address to send notifications, the sender's email address, the address to send the DLP notifications, the SMTP server, the SMTP server port, and the time interval between checking the mail queue. IWSVA supports sending notifications to IPv4 and IPv6 hosts. The Web UI can accept both hostname and IPv6 address as with IPv4.
4. If your mail server requires ESMTP, enable **Use Extended Hello (EHLO)** for IWSVA to initialize SMTP sessions using the EHLO command.
5. Click **Save**.

## Notification Tokens/Parameters

To make notifications more meaningful, IWSVA can use tokens (or variables) as information placeholders in a notification. When an event occurs, IWSVA dynamically substitutes the specific information in place of the variable, providing detailed information about that specific event.

For example, you could create a generic notification as follows:

```
A virus was detected in HTTP traffic.
```

This notification lets you know there is a problem, but does not provide any details. Instead, you could configure the notification using variables as follows:

```
On %Y, IWSVA detected a security risk %v in the file %F. %N
attempted to download the file from %U.
```

The notification might read as follows:

```
On 5/28/08 6:31:56 PM, IWSVA detected a security risk
JS_TEST_VIRUS in the file EXT_JS.JS. 10.2.203.130 attempted
```

to download the file from  
[http://10.2.203.130/TESTDATA/virus/NonCleanable/EXT\\_JS.JS](http://10.2.203.130/TESTDATA/virus/NonCleanable/EXT_JS.JS)

With this information, administrators can contact the client and provide more security information. The notification in this example uses five variables: %Y, %v, %F, %N and %U.

The following table contains a list of variables that can be used in notification messages and pages.

**TABLE 13-2. Description of Variables**

VARIABLE	VARIABLE MEANING	HOW THE VARIABLE IS USED
HTTPS Notifications		
%h	IWSVA hostname	The IWSVA host name where the event was triggered
%u	URL/URI	
%c	IP address:port after "https://"	Refer to the default message for %c usage example
\$\$DETAILS	Details of certificate failure reason / access denied reason	
HTTPS/HTTP and FTP Scanning		
%A	Action taken	The action taken by IWSVA
%F	File name	The name of the file in which a risk is detected, for example, anti_virus_test_file.htm
%H	IWSVA host name	The IWSVA host name where the event was triggered
%L	Detailed file name and reason	
%M	Moved to location	The quarantine folder location where a file was moved
%N	User name	



**TABLE 13-2. Description of Variables (Continued)**

VARIABLE	VARIABLE MEANING	HOW THE VARIABLE IS USED
%R	Transfer direction	
%U	URL/URI	
%V	Malware name (virus, Trojan, or Bot name)	The name of the risk detected
%X	Reasons/block type	
%Y	Date and time	The date and time of the triggering event
HTTP/HTTPS Access Denied by Application Control		
%N	User name	
%A	Action	
%P	Path and file name	
%C	Category	
%Z	Policy name	
%Y	Date and time	
%H	IWSVA host name	
Data Loss Protection		
%T	Template name	
%U	URL/URI	
%Y	Date and time	The date and time of the triggering event
%A	Action taken	
%N	User name	
%Z	Policy name	
Data Loss Protection URL Blocking		
%H	IWSVA host name	
%T	Template name	

**TABLE 13-2. Description of Variables (Continued)**

<b>VARIABLE</b>	<b>VARIABLE MEANING</b>	<b>HOW THE VARIABLE IS USED</b>
%N	User name	
%U	URL/URI	
%Y	Date and time	
%Z	Policy name	
C&C Callback Attempt Detection		
%Z	Policy name	
%N	User name	
%U	URL/URI	
%A	Action	
%K	Risk level	
HTTP/HTTPS/FTP File Type Block		
%U	URL/URI	
The following tokens are only used in messages for administrators or in user notification messages:		
%F	File name	
%A	Action taken	
%H	IWSVA host name	
%R	Transfer direction	
%X	Reasons/block type	
%Y	Date and time	
%N	User name	
%V	Virus, Trojan or Bot name	
Applets and ActiveX Security		
%D	Protocol being scanned	
%H	IWSVA host name	

**TABLE 13-2. Description of Variables (Continued)**

VARIABLE	VARIABLE MEANING	HOW THE VARIABLE IS USED
%N	User name	
%U	URL/URI	
%W	New certificate information	
%X	[reasons/block type]	
%Y	Date and time	
%Z	Policy name	
HA events		
%H	Host name	
%P	Peer name	
%R	Reason	
URL Filtering by Time Quota		
%U	URL/URI	
%C	Category	
%H	IWSVA host name	
%N	User name	
%Q	Quantity of time	
%Y	Date and time	
URL Blocked by Access Control		
%H	IWSVA host name (only works in header field)	
%N	User name	
%U	URL/URI (only works in body)	
%Y	Date and time	
%X	Reason (only works in body)	
URL Blocking by HTTP Inspection		

**TABLE 13-2. Description of Variables (Continued)**

<b>VARIABLE</b>	<b>VARIABLE MEANING</b>	<b>HOW THE VARIABLE IS USED</b>
%H	IWSVA host name	
%I	Filter name	
%N	User name	
%U	URL/URI	
%Y	Date and time	
URL Blocked by URL Filtering		
%C	Category	
%H	IWSVA host name (only works in header field)	
%N	User name	
%U	URL/URI	
%Y	Date and time	
URL Access Warning		
%A	Action	
%B	Warn and continue	
%C	Category	
%H	IWSVA host name (only works in header field)	
%N	User name	
%U	URL/URI (only works in body)	
%Y	Date and time	

**TABLE 13-2. Description of Variables (Continued)**

VARIABLE	VARIABLE MEANING	HOW THE VARIABLE IS USED
<p>To customize URL Access Warning notifications, the message template must contain following form to display the “Continue” option:</p> <pre data-bbox="443 619 1292 688">&lt;form id="warncontinue" method="post" action="%B\$\$IWSX_URL_ACTION\$\$"&gt; &lt;INPUT type="hidden" value="%A" name="data"&gt; &lt;/form&gt;</pre> <p>A button or hyperlink must be defined to submit the form about the customized notification that allows users to continue. Example:</p> <pre data-bbox="443 800 1170 869">&lt;a href="javascript:void(0)" onclick="document.getElementById('warncontinue').submit(); return false;"&gt;Continue to this website (not recommended)&lt;/a&gt;</pre>		
<p><b>URL Access Override</b></p>		
%A	Action	
%B	Continue to URL/URI	
%C	Category	
%E	Policy default Time Limit	
%H	IWSVA host name	
%J	Policy maximum Time Limit	
%N	User name	
%U	URL/URI (only works in body)	
%Y	Date and time	
%Z	Policy name	

**TABLE 13-2. Description of Variables (Continued)**

VARIABLE	VARIABLE MEANING	HOW THE VARIABLE IS USED
		<p>If you customize URL Access Override notifications, the message template must contain some Java Script code to encrypt the password with base64 code. It should contain some elements: password, time limit and ttl_type. Otherwise, the customized notification page cannot work.</p> <pre>&lt;form id="overridecontinue" method="post" action="%B[Warn and Continue URL/URI]/\$\$\$IWSX_URL_ACTION\$\$\$"&gt; &lt;INPUT type=hidden value="%A[Action]" name=data&gt;</pre> <p>A button or hyperlink must be defined to submit the form about the customized notification that allows users to continue. Example:</p> <pre>&lt;input type="button" name="Button22" value="Submit" class="style3" onclick="doSubmit();" /&gt;</pre>
Threshold Notification		
%m	Metric	
%t	Threshold value	

## Configuring Notifications

To configure a notification, select the types of events that issue the notification and then edit the email and browser notification messages.

### Using HTML Tags in User Notifications

You can use HTML to format user notification messages. While the HTML files can include reference links to external images or styles, IWSVA only supports uploading HTML files. Any additional files have to be uploaded separately to a Web server, and Trend Micro recommends using absolute links to help avoid broken links.

## Configuring Applets and ActiveX Security Notification Settings

When IWSVA detects an attempt to download a Java Applet or ActiveX object that violates a security policy, the application sends an administrator a notification through email and a user notification message in the requesting client's browser.

### To configure the Applets and ActiveX security notification settings:

1. Click **Notifications** in the main menu, then click **Applets and ActiveX Instrumentation**.
2. Under **Administrator Notification**, select **Send a message when a malicious Applet or ActiveX attempt is detected**.
3. If you do not want to use the default notification messages, highlight the default text and type your own version. If applicable, insert variables in the text as described in [Notification Tokens/Parameters starting on page 13-17](#).
4. For the **User Notification Messages**:
  - a. Select **Default** to display the default warning message.
  - b. Select **Customized** to display a custom message and either type or import the customized message's content.
    - You can design your own notification page using any HTML editor, then **Import** the page to IWSVA (for example, if you want to display company brandings, or provide a link to additional resources).
    - You can append a custom message to the IWSVA default by selecting both the Default and Customized options.
5. Click **Save**.

## Configuring C&C Contact Callback Notifications

When IWSVA detects an attempt to download C&C contact objects that violate a security policy, the application sends an administrator a notification through email and a user notification message in the requesting client's browser.

### To configure the C&C Contact Callback notification settings:

1. Click **Notifications** in the main menu, then click **C&C Callback Notification**.
2. Under **Administrator Notification**, select **Send a message when C&C callback event is detected**.

3. Choose to send the message to the root recipient after either every incident, or after a specific risk level has been surpassed (low, medium, or high).
4. If you do not want to use the default notification messages, highlight the default text and type your own version. If applicable, insert variables in the text as described in [Notification Tokens/Parameters starting on page 13-17](#).
5. For the **User Notification Messages**:
  - a. Select **Default** to display the default warning message.
  - b. Select **Customized** to display a custom message and either type or import the customized message's content.
    - You can design your own notification page using any HTML editor, then **Import** the page to IWSVA (for example, if you want to display company brandings, or provide a link to additional resources).
    - You can append a custom message to the IWSVA default by selecting both the Default and Customized options.
6. Click **Save**.

## Configuring Data Loss Prevention Notifications

When IWSVA detects data leakage that violates a security policy, the application sends an administrator a notification through email and a user notification message in the requesting client's browser.

### To configure the Data Loss Prevention notification settings:

1. Click **Notifications** in the main menu, then click **Data Loss Prevention**.
2. Under **Administrator Notification**, select **Send a message when data leakage is detected**.
3. If you do not want to use the default notification messages, highlight the default text and type your own version. If applicable, insert variables in the text as described in [Notification Tokens/Parameters starting on page 13-17](#).
4. For the **User Notification Messages**:
  - a. Select **Default** to display the default warning message.
  - b. Select **Customized** to display a custom message and either type or import the customized message's content.



- You can design your own notification page using any HTML editor, then **Import** the page to IWSVA (for example, if you want to display company brandings, or provide a link to additional resources).
  - You can append a custom message to the IWSVA default by selecting both the Default and Customized options.
5. Click **Save**.

## Configuring FTP Data Loss Prevention Notifications

When IWSVA detects FTP data leakage that violates a security policy, the application sends an administrator a notification through email and a user notification message in the requesting client's browser.

### To configure the FTP Data Loss Prevention notification settings:

1. Click **Notifications** in the main menu, then click **FTP Data Loss Prevention**.
2. Under **Administrator Notification**, select **Send a message when data leakage is detected**.
3. If you do not want to use the default notification messages, highlight the default text and type your own version. If applicable, insert variables in the text as described in [Notification Tokens/Parameters starting on page 13-17](#).
4. For the **User Notification Messages**:
  - a. Select **Default** to display the default warning message.
  - b. Select **Customized** to display a custom message and either type or import the customized message's content.
    - You can design your own notification page using any HTML editor, then **Import** the page to IWSVA (for example, if you want to display company brandings, or provide a link to additional resources).
    - You can append a custom message to the IWSVA default by selecting both the Default and Customized options.
5. Click **Save**.

## Configuring FTP Blocked File Type Notifications

In addition to scanning FTP uploads and downloads, InterScan Web Security Virtual Appliance can block file types at the FTP gateway. To prevent performance issues, the FTP scanning module supports special configurations for compressed files and large files. Spyware and grayware scanning is also supported.

InterScan Web Security Virtual Appliance FTP scanning can be deployed into your environment in conjunction with another FTP proxy server or InterScan Web Security Virtual Appliance can act as its own FTP proxy. And to help ensure the security of the InterScan Web Security Virtual Appliance server, several security-related configurations are available to control access to the InterScan Web Security Virtual Appliance server and its ports.

### To configure the FTP blocked file type notification settings:

1. Click **Notifications** on the main menu, then click **FTP Blocked File Type**.
2. Under **Administrator Notification**, check **Send a message when the FTP blocked file type is accessed**.

Depending on what IWSVA is configured to block, this option can result in a large number of notification messages sent to the default recipient. As an alternative to item-by-item notifications, bear in mind that blocked files are written to a log, and can be included in one of the IWSVA generated reports.

3. If you do not want to use the default notification messages, highlight the default text and type your own. If applicable, insert variables in the text as described in [Notification Tokens/Parameters starting on page 13-17](#).
4. For the **User Notification Message**:
  - a. Select **Default** to display the default warning message.
  - b. Select **Customized** to display a custom message and type the customized content.
    - You can design your own notification page using any HTML editor, then **Import** the page to IWSVA (for example, if you want to display company brandings, or provide a link to additional resources).
    - You can append a custom message to the IWSVA default by selecting both the Default and Customized options.
5. Click **Save**.

## Configuring FTP Scanning Notification Settings

When IWSVA detects malicious code in a user's FTP transfer, it can automatically send a customized administrator notification to the designated email addresses and/or display a notification in the requesting FTP client program.

### To configure the FTP scanning notification settings:

1. Click **Notifications** on the main menu, then click **FTP Scanning**.
2. Under **Administrator Notification**, select the trigger detection events for sending a notification (**Virus** and/or **Trojan** and/or **Other malicious code**).
3. If you do not want to use the default notification messages, highlight the default text and type your own. If applicable, insert variables in the text as described in [Notification Tokens/Parameters starting on page 13-17](#).
4. For the **User Notification Message**:
  - a. Select **Default** to display the default warning message.
  - b. Select **Customized** to display a custom message and type the customized content.
    - You can design your own notification page using any HTML editor, then **Import** the page to IWSVA (for example, if you want to display company brandings, or provide a link to additional resources).
    - You can append a custom message to the IWSVA default by selecting both the Default and Customized options.
5. Click **Save**.

## Configuring HTTP/HTTPS File Blocking Notifications

When IWSVA blocks a file, it sends an administrator notification through email, and a user notification message is displayed in the requesting client's browser.

### To configure HTTP/HTTPS file blocking notifications:

1. Click **Notifications** and then click **HTTP/HTTPS Blocked File Type**.
2. Under **Administrator Notification**, select **Send a message when the blocked file type is accessed**.
3. If you do not want to use the default notification message, highlight the default text and type your own version. If applicable, insert tokens in the text as described in [Notification Tokens/Parameters starting on page 13-17](#).

4. Type the **Headline** to appear in the browser.  
The default headline is *Trend Micro InterScan Web Security Event*. The headline is common for virus infection messages, file-type blocking, and URL blocking messages.
5. For the **User Notification Message**:
  - a. Select **Default** to display the default warning message.
  - b. Select **Customized** to display a custom message and either type or import content from an HTML file.
    - You can design your own notification page using any HTML editor, then **Import** the page to IWSVA (for example, if you want to display company brandings, or provide a link to additional resources).
    - You can append a custom message to the IWSVA default by selecting both the Default and Customized options.
6. Verify the notifications by clicking **Preview**.
7. Click **Save**.

## Configure HTTP/HTTPS Scanning Notifications

When IWSVA detects malicious code in a file requested by a client, it issues an administrator notification through email and a user notification in the requesting client's browser.

Because IntelliTrap is considered a type of security threat, it uses the same notifications as HTTP/HTTPS Scanning.

### To configure HTTP/HTTPS scanning notifications:

1. Click **Notifications** and then click **HTTP/HTTPS Scanning**.
2. Under **Administrator Notification**, select the trigger detection events for sending a notification (**Virus** and/or **Trojan** and/or **Other Internet Threats** and/or **Bots**)

---

**Note:** IntelliTrap notification is associated with **Other Internet Threats**. Therefore, IntelliTrap notification is enabled when you select **Other Internet Threats**.

---

3. If you do not want to use the default notification message, highlight the default text and type your own version. If applicable, insert tokens in the message as described in [Notification Tokens/Parameters starting on page 13-17](#).
4. Type the **Headline** to appear in the browser.  
The default is *Trend Micro InterScan Web Security Event*. The header line is common for virus infection messages, file-type blocking, and URL blocking messages.
5. For the **User Notification Message** for **Message for downloaded file** and **Message for uploaded file**:
  - a. Select **Default** to display the default warning message.
  - b. Select **Customized** to display a custom message and either type or import the customized message's content from an HTML file.
    - You can design your own notification page using any HTML editor, then **Import** the page to IWSVA (for example, if you want to display company brandings, or provide a link to additional resources).
    - You can append a custom message to the IWSVA default by selecting both the Default and Customized options.
  - c. Verify that the notifications appear correctly by clicking **Preview**.
6. Click **Save**.

## Configuring HTTPS Access Denied Notifications

Whenever users are denied to access a Web site through HTTPS connections, they will see an HTML page explaining that their request has been rejected.

### To configure HTTPS access denied notifications:

1. Click **Notifications** and then click **HTTPS Access Denied**.
2. Type the **Headline** to appear in the browser.  
The default is *Trend Micro InterScan Web Security Event*. The header line is common for virus infection messages, file-type blocking, and URL blocking messages.
3. For the **User Notification Message**:
  - a. Select **Default** to display the default warning message.
  - b. Select **Customized** to display a custom message and either type or import content from an HTML file.

- You can design your own notification page using any HTML editor, then **Import** the page to IWSVA (for example, if you want to display company brandings, or provide a link to additional resources).
  - You can append a custom message to the IWSVA default by selecting both the Default and Customized options.
4. Verify the notifications by clicking **Preview**.
  5. Click **Save**.

## Configuring HTTPS Certificate Failure Notifications

Whenever users are denied to access a Web site whose certificate does not pass the verification tests, they will see an HTML screen with the warning message. Users have the option to continue accessing the Web site without decrypting and checking HTTPS traffic.

### To configure HTTPS certificate failure notifications:

1. Click **Notifications** and then click **HTTPS Certificate Failure**.
2. Type the **Headline** to appear in the browser.  
The default is *Trend Micro InterScan Web Security Event*. The header line is common for virus infection messages, file-type blocking, and URL blocking messages.
3. For the **User Notification Message**:
  - a. Select **Default** to display the default warning message.
  - b. Select **Customized** to display a custom message and either type or import content from an HTML file.
    - You can design your own notification page using any HTML editor, then **Import** the page to IWSVA (for example, if you want to display company brandings, or provide a link to additional resources).
    - You can append a custom message to the IWSVA default by selecting both the Default and Customized options.
4. Verify the notifications by clicking **Preview**.
5. Click **Save**.

## Configuring HTTP/HTTPS Access Denied by Application Control Notifications

Whenever users are denied to access an HTTP/HTTPS Web site whose certificate does not pass the verification tests, they will see an HTML screen with the warning message. Users have the option to continue accessing the HTTP/HTTPS Web site without decrypting and checking HTTP/HTTPS traffic.

### To configure HTTPS certificate failure notifications:

1. Click **Notifications** and then click **HTTP/HTTPS Access Denied by Application Control**.
2. Type the **Headline** to appear in the browser.  
The default is *Trend Micro InterScan Web Security Event*. The header line is common for virus infection messages, file-type blocking, and URL blocking messages.
3. For the **User Notification Message**:
  - a. Select **Default** to display the default warning message.
  - b. Select **Customized** to display a custom message and either type or import content from an HTML file.
    - You can design your own notification page using any HTML editor, then **Import** the page to IWSVA (for example, if you want to display company brandings, or provide a link to additional resources).
    - You can append a custom message to the IWSVA default by selecting both the Default and Customized options.
4. Verify the notifications by clicking **Preview**.
5. Click **Save**.

## Enabling Pattern File Updates Notifications

IWSVA can send notifications when the product attempts to update engines or pattern files based on scheduled pattern updates.

---

**Note:** IWSVA will not send notifications for manual pattern updates.

---

**To enable pattern file update notifications:**

1. Click **Notifications** from the main menu, then click **Pattern File Updates**.
2. For the pattern update attempts:
  - a. Select the update events that trigger a notification. You can configure notifications for **Successful**, **Unsuccessful** or **Not needed** update attempts.
  - b. Type a **Subject** for the notification message. Default is *IWSVA pattern update result*.
3. Click **Save**.

## Configuring Threshold Alert Settings

IWSVA can send notifications when the product has exceeded the threshold values you have set.

**To enable threshold alert notifications:**

1. Click **Notifications** from the main menu, then click **Threshold Alerts**.
2. For the thresholds alerts:
  - a. Enable the threshold alert type, value, and the frequency limitations of your notification messages.
  - b. To change the recipient, click **Notifications** in the main menu, and then “**Send notifications to...**” in the upper right corner.
  - c. Use the default message or create one of your own under **Notification Message**.
3. Click **Save**.

## Configuring URL Access Warning Notifications

The URL Access Warning Mode sends notifications if the URL Filtering rules action is set to “Warn” and the user attempts to access a URL that belongs to a category prohibited by company policy. (See [Creating a New Policy on page 10-6](#) for details.) The user receives the warning before seeing the Web page.

The user has an option to click one of the following links in the warning message:

- Go back to previous webpage safely OR
- Continue at your own risk (not recommended)



**To configure the URL Access Warning notifications:**

1. Click **Notifications** on the main menu and then click **URL Access Warning**.
2. Type the **Headline** to appear in the browser.  
The default is *Trend Micro InterScan Web Security Event*. The header line is common for virus infection messages, file-type blocking, and URL blocking messages.
3. For the **User Notification Message**:
  - a. Select **Default** to display the default warning message.
  - b. Select **Customized** to display a custom message and either type or import content from an HTML file.
    - You can design your own notification page using any HTML editor, then **Import** the page to IWSVA (for example, if you want to display company brandings, or provide a link to additional resources).
    - You can append a custom message to the IWSVA default by selecting both the Default and Customized options.
    - The notification must contain a form to submit necessary information to IWSVA if end users choose to continue. The format is:

```
<form id="warncontinue" method="post" action="%B$$$IWSX_URL_ACTION$$$">
<INPUT type=hidden value="%A" name=data>
</form>
```

- A button or hyperlink must be defined to submit the form about the customized notification for users to continue. Example:

```
<a href="javascript:void(0)"
onclick="document.getElementById('warncontinue').submit();
return false;">Continue to this website (not recommended)
```

4. Verify the notifications by clicking **Preview**.
5. Click **Save**.

## Configuring URL Access Override Notifications

A user receives the URL Access Override Mode notification if a user tries to access a URL in a category that has a “block with override” action set by company policy. The user receives the override warning and needs to enter a password to continue. In the notification, the user sees the amount of additional time allowed for browsing. After entering the correct password, the user continues to the requested Web page.

The user has an option to click one of the following links in the warning message:

- Discontinue browsing that page if password is not known
- Enter the password and continue browsing for the specified period of time

The administrator must first set the category action in the policy to the “Block with Override” action setting. See [Creating a New Policy on page 10-6](#) for details.

### To configure a user notification message for URL Access Overrides:

1. Click **Notifications** in the main menu, then click **URL Access Override**.
2. Under **User Notification Message for URL Access Override**:
  - a. Type the **Headline** to appear in the browser.

The default is *Trend Micro InterScan Web Security Event*. The header line is common for virus infection messages, file-type blocking, and URL blocking messages.
  - b. Click **Default** to display the default warning message.
  - c. Click **Customized** to display your own warning message. Type the message in the text box, or **Import** it from a HTML file on your local machine.
    - You can design your own notification page using any HTML editor, then **Import** the page to IWSVA (for example, if you want to display company brandings, or provide a link to additional resources).
    - You can append a custom message to the IWSVA default by selecting both the Default and Customized options.
  - d. If you customize URL Access Override notifications, the message template must contain some Java Script code to encrypt the password with base64 code. It should contain some elements: password, time limit and ttl\_type. Otherwise, the customized notification page cannot work.

**Example:**

```
<form id="overridecontinue" method="post" action="%B[Warn and Continue
URL/URI]$$$IWSX_URL_ACTION$$$">
<INPUT type=hidden value="%A[Action]" name=data>
..
</form>
```

- e. A button or hyper link must be defined to submit the form about the customized notification for users to continue.

**Example:**

```
<input type="button" name="Button22"
value="Submit" class="style3"
onclick="doSubmit();" />
```

3. Verify the notifications by clicking **Preview**.
4. Click **Save**.

## Configuring a URL Blocking by Access Control Notification

When IWSVA detects an attempt to access a URL in the Phish pattern file or a prohibited URL from the local IWSVA list, IWSVA displays a warning screen in the browser of the requesting client to indicate the URL was blocked.

### To configure a user notification message for URL Blocking by Access Control:

1. Click **Notifications** in the main menu, then click **URL Blocking by Access Control**.
2. Under **User Notification Message for Restricted or Blocked URLs**:
  - a. Type the **Headline** to appear in the browser.  
The default is *Trend Micro InterScan Web Security Event*. The header line is common for virus infection messages, file-type blocking, and URL blocking messages.
  - b. Click **Default** to display the default warning message.
  - c. Click **Customized** to display your own warning message. Type the message in the text box, or **Import** it from a HTML file on your local machine.

- You can design your own notification page using any HTML editor, then **Import** the page to IWSVA (for example, if you want to display company brandings, or provide a link to additional resources).
  - You can append a custom message to the IWSVA default by selecting both the Default and Customized options.
3. Verify the notifications by clicking **Preview**.
  4. Click **Save**.

## Configuring a URL Blocking by HTTP Inspection Notification

When IWSVA detects an attempt to access a URL in violation of an HTTP Inspection policy with a blocking action, IWSVA displays a warning screen in the browser of the requesting client to indicate the URL was blocked.

### To configure a user notification message for HTTP Inspection:

1. Click **Notifications** in the main menu, then click **URL Blocking by HTTP Inspection**.
2. Under **User Notification Message for Restricted or Blocked URLs**:
  - a. Type the **Headline** to appear in the browser.

The default is *Trend Micro InterScan Web Security Event*. The header line is common for virus infection messages, file-type blocking, and URL blocking messages.
  - b. Click **Default** to display the default warning message.
  - c. Click **Customized** to display your own warning message. Type the message in the text box, or **Import** it from a HTML file on your local machine.
    - You can design your own notification page using any HTML editor, then **Import** the page to IWSVA (for example, if you want to display company brandings, or provide a link to additional resources).
    - You can append a custom message to the IWSVA default by selecting both the Default and Customized options.
3. Verify the notifications by clicking **Preview**.

## Configuring a URL Blocking by URL Filtering Notification

When IWSVA detects an attempt to access a URL in the Phish pattern file or a prohibited URL from the local IWSVA list, IWSVA displays a warning screen in the browser of the requesting client to indicate the URL was blocked.

### To configure a user notification message for URL Blocking by URL Filtering:

1. Click **Notifications** in the main menu, then click **URL Blocking by URL Filtering**.
2. Under **User Notification Message for Restricted or Blocked URLs**:
  - a. Type the **Headline** to appear in the browser.  
The default is *Trend Micro InterScan Web Security Event*. The header line is common for virus infection, file-type blocking, and URL blocking messages.
  - b. Click **Default** to display the default warning message.
  - c. Click **Customized** to display your own warning message. Type the message in the text box, or **Import** it from a HTML file on your local machine.
    - You can design your own notification page using any HTML editor, then **Import** the page to IWSVA (for example, if you want to display company brandings, or provide a link to additional resources).
    - You can append a custom message to the IWSVA default by selecting both the Default and Customized options.
3. Verify the notifications by clicking **Preview**.
4. Click **Save**.

## Enabling Notifications for URL Filtering Engine and Scan Engine Updates

Though less frequent than pattern file updates, Trend Micro periodically releases new versions of the scan engine to reflect advances in virus and malicious code detection methods. IWSVA can issue administrator notifications in response to scheduled scan engine updates.

---

**Note:** IWSVA will not send notifications for manual engine updates.

---

**To enable URL Filtering and Scan Engines Update Notifications:**

1. Click **Notifications** from the main menu, then click **URL Filtering and Scan Engines Update**.
2. For the scan engine and/or the URL filtering engine, select the update events to trigger a notification.  
You can configure notifications for **Successful**, **Unsuccessful**, or **Not needed** update attempts.
3. For the scan engine and/or the URL filtering engine, type the **Subject** of the notification email message.
4. Click **Save**.

## Configuring URL Filtering by Time Quota Notification Settings

If a rule in a URL Filtering policy has a time limit action, the URL Filtering by Time Quota notification can be received by a user. End-users will see it appear in their Web browser whenever a policy is configured with the “Time Limit” action in **URL Filtering > Policies | Rule** tab. See [Creating a New Policy on page 10-6](#) for details.

Whenever users try to download a page that has been configured in IWSVA with a time limit action, and if the time limit has been exhausted, they will see an HTML page explaining that their request has been rejected (if the option is enabled). See [URL Filtering Time Quota Extension on page 10-14](#) for details.

**To configure the URL Filtering by Time Quota notification settings:**

1. Click **Notifications** in the main menu, then click **URL Filtering by Time Quota**.
2. If you do not want to use the default notification message, check the Customized check box and type your own version. If applicable, insert variables in the text as described in [Notification Tokens/Parameters starting on page 13-17](#).
3. Click **Save**.

## Enabling SNMP Trap Notifications

IWSVA supports sending SNMP traps in response to security, update, or program events.

---

**Note:** To send SNMP traps, you need to configure the SNMP settings and then enable this feature. Choose **Administration > Network Configuration > SNMP Settings**.

---

**To enable sending SNMP traps:**

1. Click **Notifications** on the main menu and then click **SNMP Notification Settings**. . . at the bottom of the screen.
2. Select the types of events that triggers an SNMP trap. The different classes are:
  - **Virus or Internet threats**—Events related to virus or malicious code detections
  - **Security violations**—Activities that are prohibited by IWSVA policies, not related to viruses or malicious code
  - **Pattern, database or scan engine updates**—Events related to IWSVA updates
  - **IWSVA service interruptions**—Issues with any of the essential IWSVA services
  - **System performance metric**—IWSVA periodically sends an SNMP trap with the following performance data:
    - CPU load percentage
    - Memory load percentage
    - Disk load percentage
    - Concurrent connection (ICAP request and response mode and proxy mode)
    - Incoming and outgoing throughput (bytes per second)
  - **High Availability events**—Issues with any of the essential HA functions, if HA is used.
  - **Hardware monitoring events**—Events related to monitored hardware components:
    - Voltage
    - Fan
    - CPU

- Storage
  - Temperature
3. Click **Save**.

## Enabling MAC Address Client Identification

If you select Host name (modified HTTP headers) in the User Identification screen, IWSVA displays client IP address information in logs, reports, and notifications. You can also configure IWSVA to display client MAC address information.

---

**Note:** To identify a client by the MAC address, you must select **Host name (modified HTTP headers)** in the User Identification screen. Host name identification is only supported for end-users browsing with Internet Explorer on Microsoft Windows platforms.

---

### To display client MAC addresses in logs, notifications, and reports:

1. You can obtain the `register_user_agent_header.exe` file from the `/usr/iwss/bin` folder on the IWSVA server or download it from following Web site:  
<http://www.trendmicro.com/download/product.asp?productid=86>
2. Run `register_user_agent_header.exe` on each client computer. The program configures the computer to include MAC address information in data packets.
3. Log on to the Web console on the IWSVA server and make sure the **Host name (modified HTTP headers)** option is selected in the User Identification screen (**Administration > IWSVA Configuration > User Identification | User Identification**).
4. Access the privileged CLI commands on the IWSVA server and type: `configure module identification mac_address enable`.

### To disable client MAC address identification:

Access the privileged commands on the IWSVA server and type: `configure module identification mac_address disable`.



# Chapter 14

## Administration

This chapter describes the administrative functions available in IWSVA.

Topics in this chapter include the following:

- [Overview on page 14-2](#)
- [Audit Log on page 14-3](#)
- [IWSVA Configuration on page 14-3](#)
- [Network Configuration on page 14-18](#)
- [Management Console on page 14-22](#)
- [Syslog Server on page 14-24](#)
- [Config Backup/Restore on page 14-24](#)
- [System Updates on page 14-25](#)
- [System Maintenance on page 14-26](#)
- [System Event Log on page 14-27](#)
- [Product License on page 14-27](#)
- [Support on page 14-31](#)

## Overview

The Administration menu includes the following options:

- [Audit Log on page 14-3](#)
- [IWSVA Configuration on page 14-3](#)
  - [User Identification on page 14-4](#)
  - [Policy Deployment on page 14-11](#)
  - [Database Connection on page 14-11](#)
  - [Quarantine Management on page 14-12](#)
  - [System Time on page 14-13](#)
  - [Scheduled Times on page 14-14](#)
  - [Register to Control Manager on page 14-15](#)
  - [Replication Configuration on page 14-16](#)
- [Network Configuration on page 14-18](#)
  - [Network Interface on page 14-18](#)
  - [Web Console on page 14-19](#)
  - [Remote CLI on page 14-19](#)
  - [SNMP Settings on page 14-20](#)
  - [Static Routes on page 14-21](#)
- [Management Console on page 14-22](#)
  - [Account Administration on page 14-22](#)
  - [Access Control Settings on page 14-23](#)
- [Syslog Server on page 14-24](#)
- [Config Backup/Restore on page 14-24](#)
- [System Updates on page 14-25](#)
- [System Maintenance on page 14-26](#)
- [System Event Log on page 14-27](#)
- [Product License on page 14-27](#)
- [Support on page 14-31](#)

## Audit Log

The audit log contains information that describes any configuration changes that users make to the application. For instance, after a migration or rollback procedure is activated by a user, an entry recording the migration activity is created in the audit log.

---

**Note:** All IPv6 related configuration changes will be logged the same as the IPv4 audit logs.

---

### To view the audit log:

1. Click **Administration > Audit Log** in the main menu.
2. Under **Time period**, select the time for which you want a report generated. Click **Range** to view the virus log in a given time range, then select the start and end dates.
3. Under **User(s)**, select the user(s) for which you want to view log entries. Click **Add** (or **Add All** for all users listed). To remove user(s) from the right list box, click **Remove** (or **Remove All** for all users listed).
4. Under the **Sort by** section, select an option by which to sort the display log. The options are “User” and “Date.”
5. Click **Show Log**. The **Audit Log** screen opens.
6. Click **Refresh** to update the screen.

## IWSVA Configuration

IWSVA Configuration contains the following items:

- [User Identification on page 14-4](#)
- [Policy Acknowledgement Screen on page 14-9](#)
- [Authentication White List on page 14-11](#)
- [Policy Deployment on page 14-11](#)
- [Database Connection on page 14-11](#)
- [Quarantine Management on page 14-12](#)
- [System Time on page 14-13](#)
- [Scheduled Times on page 14-14](#)

- [Register to Control Manager on page 14-15](#)
- [Replication Configuration on page 14-16](#)
- [Central Log/Reporting on page 14-17](#)

## User Identification

IWSVA supports multiple user identification methods:

- IP address
- Host name
- User/group name

---

**Note:** Changing the user identification method can affect any existing policies you might have created, as well as logs and reports.

---

With IWSVA, when you want to use a user/group-based policy and you have an LDAP server on the network, choose the **User/group Authentication Setting** and contact your LDAP administrator for information about the various attribute settings.

Select your preferred method of user identification for reports, logs, notification messages, and for creating scan policies.

## User/Group Authentication Settings

### Basic (single Active Directory server)

With IWSVA's enhanced LDAP functionality, several settings for Microsoft's Active Directory can automatically be detected that will simplify your configuration. Many use Microsoft Active Directory; this might be the best option for those with less-complex configurations.

Under the **Basic** view, only the following settings are necessary:

- Domain name
- Service account
- Password

Your LDAP vendor must use Microsoft Active Directory for the auto-detect function to work correctly. IWSVA automatically detects all the available servers for any given domain and then chooses the most appropriate one for your configuration, as well as other important settings.

IWSVA does auto-detection as follows:

- Acquires the LDAP server list through a DNS query
- Filters out unconnected servers
- The fastest GC or DC will be selected as the primary LDAP server when more than one GC or DC is located among LDAP servers.
- Domain names will be translated into BDN.
- Kerberos information is generated and authenticated.

### **Advanced (other or multiple LDAP servers)**

Use this option to do fine-grained or complex LDAP configurations. Besides Active Directory, other LDAP servers as well as multi-domain forests and redundant LDAP servers are supported in the Advanced view. You can add multiple domains for User/Group Authentication. IWSVA sequentially queries these domains for user identification and policy enforcement.

You can add, remove, or edit domain configurations from the Advanced view, and create a list that shows all the configured domains. View the details of any one domain by clicking the domain name or the down-array button.

---

**Note:** IWSVA cannot check whether a domain is a sub-domain. If you specify two domains, one is going to be the other's sub-domain, but IWSVA treats them as independent domains.

---

### **To configure the New LDAP Configuration page:**

1. Click **Add New Domain** or any existing LDAP domain name to view the details.
2. Enter or edit the LDAP domain name, vendor, account and password, the LDAP server host name, and the Base Distinguished Name (BDN).
3. For the Authentication Method, select one that meets your expectations, then enter your Kerberos domain or realm, the Kerberos server, and the Kerberos port.
4. For Authentication High Availability, you can enable additional server relationships for the same domain by selecting **Enable high availability**. Set the server

relationship (Round Robin or Fail-over) and enter the names of any additional backup LDAP servers.

Configuring one domain is a considerable undertaking. To complete a simple configuration, use the auto-detect button provided in the Basic view. It automatically fills the form. You can modify the domain configuration base on the output of an auto-detected configuration. This button is only available for Microsoft Active Directory users in the Basic view.

To some extent, the authentication method settings depend on the LDAP vendor. Some authentication methods are only valid for certain vendors. The following table shows their relationship.

**TABLE 14-1. LDAP Vendor Authentication Method Relationships**

	<b>ACTIVE DIRECTORY</b>	<b>OPENLDAP</b>	<b>SUN IPLANET DIRECTORY SERVER</b>
Simple	✘	√	√
Kerberos	√	√	✘
Digest - MD5	✘	√	√

IWSVA supports high availability for LDAP authentication. You can specify one backup LDAP server that shares the same configuration with the primary one. However, two high availability modes are supported:

- Round Robin: By default, IWSVA alternately authenticates users with all LDAP servers.
- Fail-over: When the primary server is down, IWSVA refers to other servers to authenticate users.

---

**Note:** Each domain can configure only one BDN and LDAP server type, and the BDN should be unique from other domains.

When multiple domains are supported, you can use any account that belongs to any domain to log in. At first, IWSVA checks the domain names, then authenticates users for the matched domain name server. If no domain name has been input, it will use the first one as the default login domain name.

---

5. After your configuration is ready, click **Save**. Click **Cancel** to start over. After successfully saving your configuration, return to the LDAP server list.

The following conditions cannot be saved; you will be prompted with a corresponding error message:

- No LDAP servers present
- No BDN listed
- Missing administrator account or password
- Missing authentication information when choosing Advanced Authentication Mode
- Failing to pass the LDAP connection test

## Captive Portal

By selecting the Captive Portal Authentication Method, you can create a customized login interface page that appears when users first access your restricted network or are not recognized by IWSVA.

IWSVA also provides an Advanced mode to create a customized Captive Portal. In the Advanced mode, you can write your own HTML. However, at least the following JavaScript must first be inserted into a customized Captive Portal:

```
<SCRIPT LANGUAGE="JavaScript">function
accesspolicy(){var str1 =
window.location.href;//alert(str1);var
s=str1.indexOf("?forward=");//alert(s);var
d=str1.indexOf("&IP");//alert(d);var
uri=str1.substring(s+9,d)+"/$$$GUEST_POLICY$$$";//alert(
uri);return uri;}</SCRIPT><form name="loginForm"
method="POST"
```

```
action="com.trend.iwss.gui.servlet.captiveportal"><tr><td>User name: </td><td><input name="username" type="text" class="button" size="24" /></td><td> </td></tr><tr><td>Password:</td><td><input name="password" type="password" class="button" size="24" /></td><td><input name="Submit" type="submit"></td></tr></form><div class="accessmsg" [Display GuestPolicy Message...] >If you are a guest, please select the Guest Access option to access the Internet</div><input name="Access" type="button" onclick="window.location.href=accesspolicy();" [Display GuestPolicy...]/>
```

This Java Script is required for the Authentication Form, the Guest Access button, and the Event Handler to appear. Without this script, users will be unable to pass the authentication.

---

**Note:** Captive Portal is not supported in ICAP mode.

---

### Allow Guest Login

You can enable guest access when the **Allow Guest Login** box is checked. When enabled, an additional button labeled **Guest** appears. Guests can access the Internet by selecting this button, however, their behavior is under the control of the guest policy. The guest policy automatically appears when guest access is enabled in the policy list. Otherwise, it is invisible.

#### To allow guest access:

1. Select the Captive Portal (Custom Authentication Page delivered by IWSVA to browser) option.
2. Click the **Allow Guest Login** checkbox.
3. You can predesign a “look” for the Captive Portal page and save it as HTML. Match the look and feel of your own corporate branding through the use of colors, logos, and text. Copy and paste your customized HTML code into the empty box. Use the `<%cred%>` tag to display the login credentials and guest access buttons.
4. Click **Preview Login Screen** to view your results.
5. Click **Save** to preserve your settings.



### Cookie Mode

Cookie mode is used for user identification in NAT and terminal server environments. To use Cookie Mode, ensure that Adobe Flash Player has been installed on the client machine and that browser cookies are enabled.

Cookie Mode is only available when user/group authentication is enabled.

Use the “Stay signed in” option on the Captive Portal login page to enable cookie “lifetime” for up to one year. If the “Stay signed in” option is not selected, cookie “lifetime” is one day.

### None

(Not recommended) Logged events and reports will be anonymous; URL Filtering and other policies are created based on IP addresses.

- 
- Note:**
1. Host name identification is only supported for end-users browsing with Internet Explorer on Microsoft Windows platforms.
  2. Because IWSVA is unable to obtain host name information before decrypting HTTPS contents, IWSVA does not support host name identification for HTTPS decryption policies in the bridge or WCCP modes.
  3. You can use the `configure module identification mac_address enable` command in the CLI to include the machine address (MAC) of the client computers in event logs, reports, and notifications. You must run the `register_user_agent_header.exe` file on each client.
- 

**WARNING!** Before choosing the Host name, you need to prepare all clients on the LAN by running the `register_user_agent_header.exe` file on each client. This file can be found as part of the installation package. You can conveniently run this file by adding it to your Windows domain login script (or by creating one for just this purpose).

---

## Policy Acknowledgement Screen

The Policy Acknowledgement Screen tab informs corporate network users of the company Internet usage policy.

## Basic Mode

When the Policy Acknowledgement Screen (PAS) is enabled, users are shown a copy of your corporate internet access policy. However, before the **Policy Acknowledgement Screen** can be used, LDAP authentication must first be enabled.

The PAS can be customized through the **Policy Acknowledgement Screen** tab in the User Identification tab. You can also enable or disable the **Policy Acknowledgement Screen** in this location.

### Customize a Policy Acknowledgement Screen:

1. **Display Policy Acknowledgement Screen** - When this box is checked, whether or not IWSVA can authenticate users transparently, all users will be directed to the PAS. If IWSVA fails to authenticate the user transparently, Captive Portal will request users to provide a username and password to continue. If IWSVA has already authenticated the user transparently, users can click the button labeled “Go” to continue. In both cases, PAS will appear and reveal your company’s usage policy for those accessing the Internet. The PAS only appears when the user accesses the Internet for the first time. After that, it does not appear until the cache expires.

### Customize a Policy Acknowledgement Screen with Basic Settings:

1. Enter a Welcome message.
2. Enter your company name: such as Trend Micro, Google, and so on.
3. Upload a company logo. Image size should be less than 1MB.
4. Enter an external HTTP link.
5. Enter a policy message.
6. Click **Save**.

### Display a Policy Acknowledgement Screen:

1. Access the screen options at **Administration > IWSVA Configuration > User Identification | Policy Acknowledgement Screen**.
2. Click the check box for Display Policy Acknowledgement Screen. A separate screen will appear displaying an appropriate use policy message to users each time they access the Internet after a 24-hour cycle.
3. Configure this screen in one of two ways. The Basic mode or the Advanced mode - as described in the sections that follow.

## Authentication White List

After enabling LDAP authentication, all users must provide a username and a password except that whose IP addresses fall within your company's Authentication White List. You can define this list with a particular IP address, IP Range, or an IP Mask. Select **Administration > IWSVA Configuration > User Identification > Authentication White List** to create or edit your company's white list.

## Policy Deployment

After creating or modifying a policy, you can immediately deploy it to the IWSVA policy database by clicking **Deploy**. Alternatively, you can do nothing and the policies will be automatically deployed according to the Time-to-Live (TTL) interval set in the Administration > Policy Deployment page.

By default, IWSVA will automatically deploy new policies after 30 minutes for the following types of Application Control/HTTP policies:

- Virus scan policy
- HTTPS policy
- Applet and ActiveX policy
- HTTP Inspection policy
- URL filtering policy
- Access quota policy
- Application Control policy
- DLP policy

## Database Connection

IWSVA uses either an existing PostgreSQL database, or installs its own PostgreSQL database. The database holds policy settings and log data. Product configuration settings are stored in the "intscan.ini" file. These fields show the choices made during Setup, and should not be changed independent of the Linux ODBC Data Source.

Database Connection Settings:

- **ODBC data source name**—Shows the ODBC name chosen during Setup.
- **User name**—Shows the user name for the ODBC data source; determined during Setup. Default is “sa”
- **Password**—Displays the encrypted ODBC password chosen during Setup.
- **Test Database Connection**—Click to check that the Policy Database and Log Database connections are correct and that the connection is working. Response messages are generated from the native ODBC data source.

## Quarantine Management

Most Internet threats, including spyware, Trojans, and worms cannot be “cleaned” because they do not actually “infect” the file. Trend Micro recommends you delete worms (because of the huge numbers possible) and quarantine or delete spyware, Trojans, and other unwanted programs that IWSVA has been configured to detect.

### Quarantine Directory

Specify quarantine directory—When the Scan Policy Action for HTTP and/or FTP scanning is Quarantine, IWSVA moves those files to the directory specified here. The default location is:

```
/var/iwss/quarantine
```

---

**Note:** Trend Micro recommends that you encrypt all quarantined files as described in [Encrypting Quarantined Files on page 14-12](#).

---

### Encrypting Quarantined Files

Quarantined files are likely to be dangerous. Encrypting files for quarantine can help protect against accidental reinfection or the effects of some other type of malicious code.

Trend Micro recommends that if you choose to quarantine rather than delete suspect files, that you encrypt them before saving to the quarantine directory.

---

**Note:** See the “How to” section of the IWSVA Online Help for instructions on decrypting quarantined files.

---

**To encrypt HTTP quarantines:**

1. Click **HTTP > Advanced Threat Protection > Policies**, and then either choose an existing policy from the list, or click **Add** to create a new one.
2. Open the **Virus/Malware Scan Rule** tab. At the bottom of the page, click the **Encrypt quarantined files** check box.

**To encrypt FTP quarantines:**

1. Click **FTP > Scan Rules**.
2. Open the **Virus Scan Rule** tab. At the bottom of the page, click **Encrypt quarantined files**.

## System Time

In the System Time page of the IWSVA Web console, you can manually configure the date and time. IWSVA also supports NTP servers and synchronizes the date and time information based on the specified schedule.

### System Time Settings

**Synchronize date and time with an NTP server**—Select this option to obtain date and time information from the specified NTP server. IWSVA supports both IPv4 and IPv6 NTP servers. You can enable automatic time synchronization based on the schedule you select from the list. Click **Synchronize Now** to connect to the NTP server and update the system date and time. This also allows you to test whether the NTP server is available.

**Set the system time manually**—Select this option and enter the system date and time in the fields.

### Time Zone

Select your continent and nearest city from the lists provided.

## Scheduled Times

When configuring URL Filtering, HTTP Inspection, or Application Control policies, you can have IWSVA differentiate between multiple scheduled times. For example, you can allow recreational Web surfing or use of IM applications before and after scheduled work hours. Filtering schedules can be policy based—different schedules can be given to different individuals or groups.

## Scheduled Time Settings

IWSVA enables you to specify the settings of the days and hours you want to set for different actions. When creating URL Filtering, HTTP Inspection, or Application Control policies, you can set the policy to be in effect for specific scheduled times.

IWSVA policies permit or block access to URL categories during these scheduled times. By default, IWSVA uses the following default scheduled time settings:

- **Working time**—Select the scheduled time you would like work-hour restrictions to apply.
- **Leisure time**—Time not defined as working time is considered leisure. Specify the times during which you want to allow access to selected URLs or protocol categories.

---

**Note:** It is assumed that all IWSVA devices in a cluster are within the same time zone.

---

Before implementing URL filtering policies in your organization, Trend Micro recommends creating a new time object for your time schedule.

### To configure the Scheduled Times:

1. Open the IWSVA Web console and click **Administration > IWSVA Configuration > Scheduled Times**.
2. Select the time period to which you want to apply this policy.
3. Click **Save**.

### To apply a policy for all days:

- If you want to apply the action for all times, select “Always.”

**To configure the URL filtering policy schedule:**

1. Open the IWSVA Web console and click Administration > IWSVA Configuration > Scheduled Times.
2. Input the time object name and description. Select the time period in which you would like to apply the action.
3. Click Save.

## Adding Scheduled Times

In addition to work time and leisure time, you can specify additional scheduled time policies that permit or block access to URL categories during these scheduled times.

**To add a scheduled time:**

1. Open the IWSVA Web console and click **Administration > IWSVA Configuration > Scheduled Times | Add**.
2. Enter a name and description of this scheduled time instance.
3. Use your mouse to drag and block out time slots that apply to this policy.
4. Click **Save**.

## Register to Control Manager

---

**Note:** Control Manager does not support IPv6, so you will not be able to connect TMCM with an IPv6 connection. IWSVA can connect to TMCM with IPv4 addresses and retain all other legacy functionality.

---

Use the **Administration > IWSVA Configuration > Register to Control Manager** screen to configure the communication between the Communication Protocol (MCP) agent and the Trend Micro Control Manager server.

- **Connection Settings**—Specify the entity name (instance of IWSVA on the particular machine). The entity name appears in the Control Manager product tree, helping you to identify the product.

- **Control Manager Server Settings**—Specify the FQDN (Fully Qualified Domain Name) or IP address of the Control Manager server. The Web server authentication user name is used by the Internet Information Services (IIS) server for authentication. This information is not used by Control Manager.
- **MCP Proxy Settings**—In this section, specify the proxy server for communication with the Control Manager server.
- **Two Way Communication Port Forwarding**—Two-way communication allows the TMCM server to send commands in real-time to IWSVA. If the user does not specify this information, the agent defaults to one-way communication, which means IWSVA polls the TMCM server at set intervals to retrieve the commands.

## Replication Configuration

Provides IWSVA device registration and configuration replication from an IWSVA source instance to an IWSVA receiver instance. When you would like to copy the policies and configuration files of one IWSVA device to one or more other IWSVA destinations on a manual or recurring basis, use Replication Configuration.

---

**Note:** This feature does not support HA models.

---

### To set up a replication configuration policy:

1. Open the IWSVA Web console and click **Administration > IWSVA Configuration > Replication Configuration**.
2. Choose a server role, whether standalone (default), source, or receiver.  
If source, click **Save**. A pop-up message appears to confirm a successful replicate source has been established. Click **OK**.  
If receiver, continue with the following steps.
3. Enter a replication source management IP address, port, and security protocol.



4. Enter the name and password of the Replication Source Administrator Account. The policy replication occurs hourly.
5. Click **Save**.

**To configure a replication server:**

1. Select the “Configuration replication source” server role.
2. Click **Save**. When the Receiver List appears, select the receiver you would like to replicate.
3. Click **Replicate Now**.
4. Choose the desired method of replication on the pop-up that appears and click **OK**.
5. The Source Configuration will replicate to receive after a manual replication has completed.
6. Set Scheduled Replication on the source and log on to the source server's shell command with the 'root' account.
7. Use a vim editor to modify the value for the key `replicate_freq=` in `/etc/iscan/intscan.ini` file. Choose the frequency you would like IWSVA to perform the scheduled replication (0~24 in hours, 0 means disable).
8. Click **Save**.

## Central Log/Reporting

IWSVA uses a log source list and status available from the server. Central Log/Reporting is supported for multiple instances of IWSVA deployments. Administrators can choose one version of IWSVA to use as the log/report console (thereafter known as the “log server.”) IWSVA will send their logs to this server.

**To set up Central Log/Reporting:**

1. Open the IWSVA Web console and click **Administration > IWSVA Configuration > Central Log/Reporting**.
2. The default server role is Standalone. Choose a server role, whether log server or log source.
  - **Log Server** - If using this option, change the server role from the “Standalone” default to “Log Server” on the server.

- **Log Source** - If using this option, you must log on to the Web console of the IWSVA server that is acting as the log source and input all pertinent information. Click **Save**. Before the registration is completed, IWSVA ensures the log server has been placed in the “log server” role. Enter the log server address and Administrator Account user name and password. If the log server's web UI is using the SSL mode, you should import the opposite IWSVA certification file to each other and then register them using an HTTPS connection.

If log server, click **Save**. A pop-up message appears to confirm a successful server source has been established. Click **OK**.

If log source, continue with the following steps.

3. Enter a log server IP address and web UI Management Port.
4. Enter the WebUI admin account and password used to export the logs from the log source.
5. Click **Save**.

## Network Configuration

Network Configuration includes the following items:

- [Network Interface on page 14-18](#)
- [Web Console on page 14-19](#)
- [Remote CLI on page 14-19](#)
- [SNMP Settings on page 14-20](#)
- [Static Routes on page 14-21](#)

## Network Interface

IWSVA supports multiple network interfaces that handle HTTP traffic in the Forward Proxy mode. Server hardware usually comes with multiple network interfaces and IWSVA can be configured to use multiple network interfaces in Forward Proxy deployment.

## Web Console

By default, the IWSVA console is accessed through an HTTP connection on port 1812. For improved security, Trend Micro recommends that you use a Secure Socket Layer connection (HTTPS).

In bridge mode, IWSVA uses the ports specified as follows:

- **Non-SSL mode**—default; access the IWSVA console using a non-secure URL, for example:

```
http://<IWSVA Server IP address:port>
```

- **Port number**—default is 1812; can be changed to any unused port (recognized by the firewall)
- **SSL mode**—recommended; choose this option to enable a secure connection to the IWSVA console
  - **SSL Certificate**—to support SSL, IWSVA needs a public key and certificate; locate the certificate you will use, and upload it to the IWSVA server
  - **SSL Password**—enter the password associated with the SSL certificate, if any.
  - **Port number**—enter the port on which you want to open the IWSVA console, for example:

```
https://<IWSVA Server IP address:port>
```

## Remote CLI

SSH (Secure Shell) is a network protocol that allows two network devices to exchange data in a secured connection. SSH replaces Telnet which sends data (including passwords) in clear text. IWSVA allows administrators to access the CLI from a remote location using SSH only.

Use **Administration > Network Configuration > Remote CLI** screen to configure SSH on IWSVA for remote CLI access.

- **SSH: Command line access**—Select this option to enable SSH connection for remote CLI access. Clear this check box to disable SSH service.
- **Port Number**—Type the service port number for SSH. The default port number is 22.

## SNMP Settings

SNMP trap notifications are especially useful for monitoring the state of the IWSVA services—IWSVA issues a trap notifying you if a service stops unexpectedly. IWSVA supports Trap Destination network management systems using either IPv4 or IPv6 addresses. IWSVA supports SNMP agent notifications for the following events:

- HTTP, FTP, and ICAP service interruptions
- Virus pattern file, Tunnel pattern file, scan engine, and URL Filtering engine updates
- Security events
- HA events

---

**Note:** If IWSVA detects that the HTTP or FTP scanning service is down, it will try twice to restart it. If the service cannot be restarted, SNMP traps will be issued to the specified destination every 30 minutes until the service restarts.

---

## System Information Setup

Specify all the necessary system information in the System Information section of the **Administration > Network Configuration > SNMP Settings** screen.

The community that you specify in the Community Name and Default Community fields identifies the community in which the SNMP object belongs. In SNMP, every managed object belongs to a community. This provides a minimal amount of security, because designating communities can define which SNMP agents can communicate.

## Access Control Setup

Specify all the necessary access control information in the Access Control section of the **Administration > Network Configuration > SNMP Settings** screen.

The fields in this section are read-only because IWSVA sends simple status and alert messages. For the Read-Only Object Identifier (OID) field, the object ID (OID) is the code for a particular message, alert, or alarm. The “object” is the actual message, alert, or alarm.

## Static Routes

Configure and deploy static route settings at **Administration > Network Configuration > Static Routes**. Both IPv4 and IPv6 address routes are supported. The Web UI accepts both IPv4 and IPv6 address formats as well.

---

**Note:** Static routes can also be added during deployment and changed using the **Administration > Deployment Wizard**.

---

The following provides a brief description of the options in this screen:

**Add**—Opens the Static Routes screen that allows you to create a new static route. You can add up to 50 static routes.

- If you bind a static route to an interface, the router setting must be in the same network segment as the interface.
- If you bind a static route to a port, the router setting must be in the same network segment as the port.

**Delete**—Deletes a static route from the list.

**Network ID**—Click a Network ID to edit settings.

**Netmask**—Displays the subnet mask of the router for this route.

**Router**—Displays the IP address of the router for this route.

**Interface**—Displays the interface that binds to this route.

**Deployment Status**—Displays whether a static route is deployed successfully.

Click **Deploy** after specifying all the required settings.

## Configuring Static Routes

### To configure a static route:

Enter the following:

- **Network ID**—Type the destination network or host ID.
- **Netmask**—Type the subnet mask.
- **Router**—Type the IP address of the router (the next hope) for this route.

- **Interface**—Select the interface that binds to this route. The router setting must be in the same network segment as the binding interface.

## Management Console

The Management Console offers the following options:

- [Account Administration on page 14-22](#)
- [Access Control Settings on page 14-23](#)

## Account Administration

Account administration allows you to add and delete login accounts. It shows all the existing accounts, giving the username, a description, and the access rights, which are:

**Administrator**—Administrators have complete and unrestricted access to the system.

**Auditor**—Auditors cannot make any configuration changes. Auditors can only view configuration, generate real-time reports and view other reports.

**Reports Only**—Reports only can generate and view other reports.

## Login Accounts

The Login Accounts page shows all the available login accounts.

- Click **Add** to create a new login account or click a username to edit an existing one.
- To delete a login account, select the check box associated with the login account and then click **Delete**.
- **Username**—The name of the user assigned to the login account.
- **Password**—Enter and confirm a secure password.
- **Description**—The field that briefly describes the login account.
- **Access Rights**—There are three levels of access:
  - **Administrator**—Users have complete and unrestricted access to the system. They can read and modify any settings accessible through the console including creating, deleting, and modifying user accounts. Users with Administrator rights can log into IWSVA through an SSH connection. This is the default access for new users.

- **Auditor**—Users cannot make any configuration changes; they can view configurations, logs, and reports and can also change their own passwords.
- **Reports only**—Users can only view the Summary pages and scheduled reports. They can generate logs and real-time report queries and change their own passwords.

## Access Control Settings

An administrator can set the access control list (ACL) to restrict access to the management console (such as the Web console, CLI, and PING requests) or to a specific IP address or IP address range.

ACL supports both IPv4 and IPv6 addresses. You can configure a rule with a single address, an address range, or a network mask.

The management ACL is disabled by default, which allows any user to access the IWSVA management console. Administrators can add one or multiple IP addresses to the management ACL. Any IP address added to the management ACL can also be deleted individually. If the list is enabled, the administrator can only connect to the IWSVA management console from an IP address displayed on the allowed IP address list.

---

**Note:** Add the IP addresses of the central managers to which IWSVA registers (such as Trend Micro Control Manager and so on) to the access list to allow them to function properly and access the necessary data from IWSVA.

---

### To enable and configure the access control list for the management console:

1. Go to **Administration > Management Console > Access Control Settings**.
2. Select one of the following options:
  - **IP address or Hostname** - to add a single IP address to the management ACL
  - **IP range** - to add a range of IP addresses to the management ACL
  - **IP mask** - to add all the IP address covered by a network segment to the management ACL

---

**Note:** No more than 20 entries can be added to the management ACL.

---

3. Click **Add** to add your entry to the allowed list.
4. Check the **Enable Administrative Access Based on Client IP** check box.

---

**Note:** At least one IP address must be added to the management ACL before enabling this feature. Only users from the allowed IP address list can access the management console.

---

5. Click **Save**.
6. To delete an entry, click the **Delete** icon on the row of the entry to be deleted and confirm the deletion by clicking **Save**.

## Syslog Server

When a syslog servers has been configured, logs can be redirected to them. You can add, edit, or remove syslog servers from IWSVA.

### To configure a syslog server:

1. Go to **Logs > Log Settings**.
2. Click **Add** under Syslog Server, or to edit an existing syslog server, click the **Syslog Server Name**.
3. Click **Enable Syslog**.
4. Specify the server name or IP address.
5. Specify the UDP Port.
6. Indicate the log type or priority level.
7. Click **Save**.

## Config Backup/Restore

The Configuration Backup & Restore page is where you can generate an IWSVA configuration file for backup. Also from this page, the configuration and policy information for the following Trend Micro products can be migrated to IWSVA:

- IWSVA 6.0
- IWSVA 6.0 SP1



---

**Note:** Those using versions IWSVA 3.1, IWSVA 5.0, IWSVA 5.1, IWSVA 5.1 SP1, IWSVA 5.5, or IWSVA 5.6 should deploy the latest patches and upgrade to version IWSVA 6.0, then do the migration to 6.0 SP1. Otherwise, you cannot import the configuration to 6.0 SP1.

---

IWSVA supports both full and partial migration. Use full migration to restore system and application settings or to apply current configuration to an IWSVA replacement machine. Perform a partial migration if you want to replace policy- and application-level configurations.

---

**Note:**

1. To perform a full migration, make sure the deployment mode, IP address, and network card(s) are the same on the two IWSVA machines.
2. OS settings, system patch information, and pattern files will not be updated after a full or partial migration.
3. IWSVA in High Availability mode only supports partial migration.

---

**To enable scheduled backup configuration files:**

1. Click the **Enable scheduled backup configuration file** check box.
2. Click **Apply**.

IWSVA will check daily for configuration and policy changes. When there are changes, a backup file is created at 23:29:00 every day and listed under “Restore Configuration File from Scheduled Backup.” You can select any backup files listed there to restore a specific configuration by clicking the green **Restore** arrow.

---

**Note:** The “Initial installed setting” is not supported when upgrading from 6.0 GM.

---

## System Updates

IWSVA does not support updates for the system, but from time to time, Trend Micro makes system updates available through the Download Center at: <http://downloadcenter.trendmicro.com/>

There are two kinds of system updates:

- Application patches
- OS updates

Both are handled in the same way and can be viewed in the History section of the **Administration > System Updates** screen. Only properly formatted and encrypted Trend Micro updates can be uploaded using this utility

**To install a system update:**

1. Get the latest update from the Trend Micro Download Center at:  
<http://downloadcenter.trendmicro.com/>
2. Go to **Administration > System Updates**.
3. Click **Browse** to locate the downloaded file.
4. Click **Upload**.
5. In the summary screen, click **Install**.
6. You may navigate to another screen after you receive the successful installation message.

---

**Note:** See [Adding System Updates or Removing an Application Patch on page 15-21](#) for instructions on removing an application patch.

---

---

**WARNING!** Updates available from other sources should never be applied to the IWSVA server.

---

---

**Note:** After updating, the IWSVA server may restart. Whether it continues to pass network traffic during this time depends on the installation mode (Bridge, HTTP proxy, or ICAP).

---

## System Maintenance

Go to **Administration > System Maintenance** to shut down or restart the system for maintenance purposes. IWSVA records the actions performed to the audit and system event logs.

**Shut down**—Select this option to turn off the appliance and stop the IWSVA service.

**Restart**—Select this option to restart the IWSVA service or the system. The IWSVA service is unavailable while the system is restarting.

**Comment**—Enter a reason for the selected action you want to perform. You cannot leave this field blank. The information you enter in this field is recorded in the logs.

## System Event Log

The system event log contains information about state changes or errors that occurred in the system. The following types of events are recorded:

- Active updates
- Product registration
- System maintenance

### To view the system event logs:

1. Click **Administration > System Event Log** in the main menu.
2. Under **Time period**, select a time (All Dates, Today, Last 7 days, or Last 30 days).  
Click **Range** to select a time range, then select the start and end dates.
3. Under **Level(s)**, select the event level(s) for which you want to view log entries.  
Click **Add** (or **Add All** for all grayware listed).  
To remove an event level from the right list box, click **Remove** (or **Remove All** for all levels listed).
4. Under the **Sort by** section, select a sort option (Server, Date, Level, or Source).
5. Click **Show Log**. The **System Event Log** viewing screen opens.
6. Click **Refresh** to update the display.

## Product License

The Product License function allows you to register and license IWSVA. Fully activating IWSVA is a two-step process. First, you must register IWSVA with Trend Micro. After registering, a valid IWSVA activation code (AC) will be provided to license the product.

A license to the Trend Micro software usually includes the right to product updates, pattern file updates, and basic technical support (“Maintenance”) for one (1) year from the date of purchase only.

To activate IWSVA, you first need a Registration Key, which you acquire during product registration. It allows you to obtain an activation code. You can activate IWSVA using the Deployment Wizard or later using the IWSVA console.

## License Expiration Warning

Typically, ninety (90) days before the Maintenance Agreement expires, you will start to receive email notifications, alerting you of the upcoming discontinuances. You can update your Maintenance Agreement by purchasing renewal maintenance from your reseller, Trend Micro sales, or on the Trend Micro Online Registration URL:

<https://olr.trendmicro.com/registration/>

## Registering IWSVA

There are several ways to register IWSVA:

- *To register if you are a new customer:*
- *To register if you are a registered user:*

### To register if you are a new customer:

1. Click the Trend Micro Product Registration Server link in your product at **Administration > Deployment Wizard > Product Activation**.
2. Click **Continue**.
3. Click **New Account**, select the Region-Language, and click **Next**.
4. In the Enter Registration Key screen, use the Registration Key that came with your product (Trend Micro Enterprise Protection DVD or License Certificate) and click **Continue**.
5. Select your product type and click **Continue**.
6. Select **I Accept** and click **Submit**.
7. Type your Company name, First Name, Last Name, and email address.
8. Confirm email address, select your country/Region, then click **Submit**.

9. Verify your registration information.
  - a. Click **Edit** to make any changes.
  - b. Click **OK**.
10. Obtain your activation code from either the confirmation page or your email.
11. Click **OK** to finish.

**To register if you are a registered user:**

1. Click the Trend Micro Product Registration Server link in your product at **Administration > Development Wizard > Product Activation**.
2. Type your login ID and password in the fields provided, and then click **Login**. You will be prompted to change your password the first time you log on.
3. In the **My Products** screen, click **Add Products** and type the Registration Key.
4. To edit your company profile, click **View/Edit Company Profile**.
5. Your Activation Code appears on the next screen. To receive a copy of your Activation Code at your registered email address, click **Send Now**.

---

**Note:** For maintenance renewal, contact Trend Micro sales or your reseller. Click **Check Status Online** at **Administration > Product License** to manually update the maintenance expiration date on the Product License screen.

---

## Obtaining a Registration Key

The Registration Key can be found on:

- Trend Micro Enterprise Solution DVD
- License Certificate (that you obtained after purchasing the product)

Registering and activating your copy of IWSVA entitles you the following benefits:

- Updates to the IWSVA pattern files and scan engine
- Technical support
- Easy access in viewing the license expiration update, registration and license information, and renewal reminders
- Easy access in renewing your license and updating the customers profile

Registration Keys have 31 characters and appear as follows:

xx-xxxx-xxxxx-xxxxx-xxxxx-xxxxx-xxxxx

## Obtaining and Entering an Activation Code

When the full version expires, IWSVA security updates will be disabled; when the evaluation period expires, both the security updates and scanning capabilities will be disabled. In the Product License screen, you can obtain an Activation Code online, view renewal instructions, and check the status of your product.

To activate IWSVA, you need an Activation Code. This can be done in several ways.

- You automatically receive an evaluation Activation Code if you download IWSVA from the Trend Micro Web site.
- You can use a Registration Key to obtain an Activation Code online.

Activation Codes have 31 characters and appear like this:

xx-xxxx-xxxxx-xxxxx-xxxxx-xxxxx-xxxxx

### To obtain and enter an activation code online:

1. Open the IWSVA console and then click **Administration > Product License**.
2. Obtain an activation code by registering IWSVA (click the link at the top of the page to register and then follow the on-screen instructions).
3. Click the **Enter a new code** link.
4. When prompted, type the activation code in the Activation Code field and then click **Activate**.

## Updating Your License

To obtain the latest license through the Web, go to **Administration > Product License** and click **Check Online Status**.

For more renewal instructions, see:

[https://olr.trendmicro.com/registration/us/en-us/instruction\\_renew.aspx](https://olr.trendmicro.com/registration/us/en-us/instruction_renew.aspx)

## Renewing a Maintenance Agreement

Trend Micro or an authorized reseller provides technical support, virus pattern downloads, and program updates for one (1) year to all registered users, after which you must purchase renewal maintenance.

If your Maintenance Agreement expires, scanning will still be possible, but virus pattern and program updates will stop. To prevent this, renew the Maintenance Agreement as soon as possible.

- To purchase renewal maintenance, contact the same vendor from whom you purchased the product. A Maintenance Agreement, extending your protection for a year, will be sent by post to the primary company contact listed in your company's Registration Profile.
- To view or modify your company's Registration Profile, log in to the account at the Trend Micro online registration Web site:

<https://olr.trendmicro.com/registration/us/en-us>

## Support

Using the case diagnostic tool (CDT), IWSVA generates core and/or system file(s) containing the system data held in memory when a process abnormally terminates. The Generate System Information File button is an extension of this feature, allowing you to package the current machine "state" at the click of a button.

The core and/or system file(s) that IWSVA generates contains the following information:

- **IWSVA information**—Includes the IWSVA product version, engine version, build number, and IWSVA hot fixes and service pack information. Product and integration settings are also part of this information
- **IWSVA/system logs**—Includes the IWSVA logs and debug logs, logs generated by syslogd daemon (if system logs are enabled), and core dump file
- **System/network information**—Includes the hardware configuration, operating system, build, system resource status, other applications installed, and network information

- **CDT-compliant configuration/plugins information**—Includes information about changes made to the CDT as a result of IWSVA adding a new component, such as a TCM or MCP agent.
- **Verbose Logging** - Create verbose logs with IP-filtering.

## Network Packet Capturing

The Network Packet Capturing wizard is located on the Administration > Support | Network Packet Capturing tab. Using the captured network packet, administrators or support teams can perform traffic debug or analysis.

With this feature, administrators can choose a single or multiple network interfaces on which to simultaneously capture network packet. After the capture starts, the elapsed time displays. The capture operation stops when the administrator clicks Stop capturing or when the (default) maximum file size of 10GB is reached.

---

**Note:** The default maximum file size limitation is configured in `/etc/iscan/network.ini`.

---

The packet capture for each interface will be save in an individual file using the naming convention of “capture-`{interface}`-`{date:time}`.pcap”. For example capture-eth0-20111101:31:31:01.pcap would be the file name for the packet capture on the eth0 network interface performed on November 1, 2011.

After the network packet capture completes, all packet capture files are saved in one compressed package file named to “capture-`{date}`.tgz”. This file displays in the downloadable list. Administrators can either download or deleted the compressed file.

## Using Network Packet Capturing

Administrators can analyze traffic with this feature that allows packet captures for selected interfaces or a single interface.

### To capture network packets:

1. Go to the **Administration > Support** page and click the **Network Packet Capturing** tab.
2. Select the appropriate interface(s) from the **Available** column.



3. Click **Add** or **Add All** to move the selected interfaces to the Selected column.
4. If needed, click **Remove** or **Remove All** to remove interfaces from the Selected column.
5. Click **Start Capturing**. The elapsed time displays. The capture stops when the maximum files size of 10GB is reached.
6. If necessary, click **Stop Capturing** to stop the packet capture before reaching the maximum file size.
7. When the capture finishes, select the appropriate generate file or select All.
8. Select an action:
  - Click **Download** and browse to save the capture file to a directory.
  - Click **Delete** to delete the generated files and click **OK**.

## Verbose Log

Verbose logging tracks all changes and settings applied using a group policy and its extension to the local computer and to users who log on to the computer. Enabling verbose logging involves adding the registry key for verbose logging.

### To enable verbose logging:

1. Enter the IP address or IP range you would like to track with verbose logging.
2. Add the entry or entries to the Selected box.
3. Click **Start Capturing**.
4. Select one of the generated verbose log types to download.
5. Choose to clean (delete) the log or download it to your computer for further evaluation.

## Deployment Diagnostic

Use Deployment Diagnostic files when working with Trend Micro technical support to help you diagnose the causes of your deployment problems.

While IWSVA generates system file(s), the application could encounter some conditions that prevent it from gathering all the possible diagnostic information. IWSVA gathers as much information as possible and also records any errors encountered in a log file with comprehensive messages that you can delete or download to you computer for further evaluation.



# Chapter 15

## Testing and Configuring IWSVA

After opening the InterScan Web Security Virtual Appliance (IWSVA) console, test the following to verify that the program is working properly. The following lists the tests described in this chapter:

- [EICAR Test File on page 15-2](#)
- [Testing Web Reputation on page 15-2](#)
- [Testing Upload Scanning on page 15-3](#)
- [Testing HTTPS Decryption Scanning on page 15-3](#)
- [Testing FTP Scanning on page 15-7](#)
- [Testing Application Control on page 15-8](#)
- [Testing HTTP Inspection on page 15-10](#)
- [Testing URL Monitoring on page 15-11](#)
- [Testing Download Scanning on page 15-12](#)
- [Testing URL Filtering on page 15-13](#)
- [Testing Spyware Scanning on page 15-13](#)
- [Testing Java Applet and ActiveX Scanning on page 15-14](#)
- [Additional IWSVA Configurations on page 15-15](#)
- [IWSVA Performance Tuning on page 15-25](#)

## EICAR Test File

The European Institute for Computer Antivirus Research (EICAR) has developed a test virus to test your antivirus appliance. This script is an inert text file. The binary pattern is included in the virus pattern file from most antivirus vendors. The test virus is not a virus and does not contain any program code.

---

**WARNING!** Never use real viruses to test your Internet security.

---

Download the EICAR test virus from the following URLs:

[http://www.eicar.org/anti\\_virus\\_test\\_file.htm](http://www.eicar.org/anti_virus_test_file.htm)

<https://secure.eicar.org/eicar.com>

Alternatively, you can create your own EICAR test virus by typing or copying the following into a text file, and then naming the file `eicar.com`:

```
X5O!P%@AP[4\PZX54(P^)7CC)7}$EICAR-STANDARD-ANTIVIRUS-TEST-FILE!
$H+H*
```

---

**Note:** Flush the URL cache (**HTTP > Configuration > WRS/URL Cache**), the Content Cache (**HTTP > Configuration > Content Cache**), and your local browser before testing. If either cache contains a copy of the test virus, it is possible an attempt to download the file would get the file from the cache, rather than getting it from the Internet, and IWSVA would not detect the file.

---

## Testing Web Reputation

To test IWSVA's Web Reputation feature, open a Web browser and type the following in the address field:

`http://wr21.winshipway.com`

If the test is successful, you should receive an IWSVA Security Event message stating, "This URL has a Web security rating that prohibits it from being accessed."

## Testing Upload Scanning

The following procedure contains instructions to test the uploaded virus:

1. Open the IWSVA console and click **HTTP > Advanced Threat Protection > Policies** in the main menu. Clear **Enable virus scanning**, and then click **Save**.
2. Download the test virus (eicar.com) from the following page:  
`http://www.eicar.org/anti_virus_test_file.htm`
3. Save the test virus on your local machine.
4. Re-open the IWSVA console, under **HTTP > Advanced Threat Protection > Policies** in the main menu, select **Enable virus scanning**, and then click **Save**.
5. Upload the test virus to a Web site. A message similar to *Figure 15-1* appears in your browser.

### Trend Micro InterScan Web Security Event



**FIGURE 15-1.** This warning screen shows the detection of an EICAR test virus.

## Testing HTTPS Decryption Scanning

This section describes the procedure to test HTTPS decryption on IWSVA in stand-alone mode.

**To test virus scanning of decrypted HTTPS traffic:**

1. Set the Web client's HTTP proxy to point to IWSVA (for example, open Internet Explorer and click **Tools > Internet Options > Connections > LAN Settings > Use a proxy server**).
2. Open the IWSVA Web console and click **HTTP > HTTPS Decryption > Settings | Server Certificate Validation** and make sure all options are selected.
3. Click **HTTP > HTTPS Decryption > Policies** and select **Enable HTTPS Decryption**.
4. Click **Add** to create a new HTTPS decryption policy. In the Rules tab, select **Disease Vector** under the Business: Computer/Internet category.
5. From the client machine, access the test virus file from the following URL:  
`https://secure.eicar.org/eicar.com`
6. Because the server certificate is not in the trusted list on IWSVA, a certificate error notification displays. Click **Visit site anyway**.

7. A security warning screen displays. The warning message varies depending on whether URL filtering is also enabled or not.

### Trend Micro InterScan Web Security Event

---

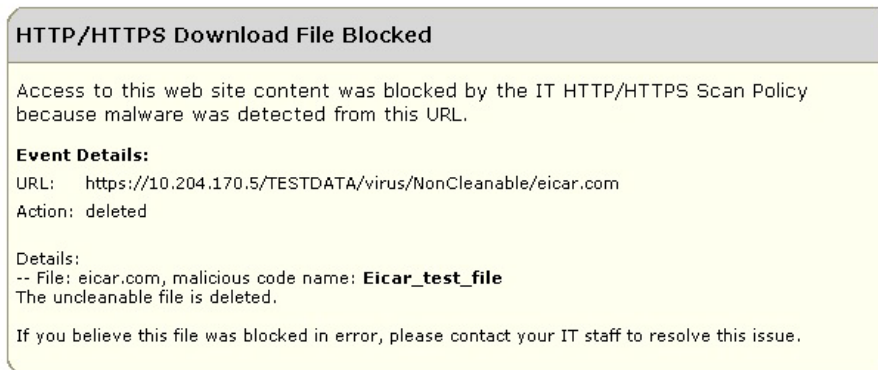

**FIGURE 15-2. Security warning screen if URL filtering is disabled**

### Trend Micro InterScan Web Security Event

---



**FIGURE 15-3. Security warning screen if URL filtering is also enabled**

On the IWSVA server, you can view detailed log information in the Internet Security log by selecting the View Detailed Logs icon from the options on the top button bar.

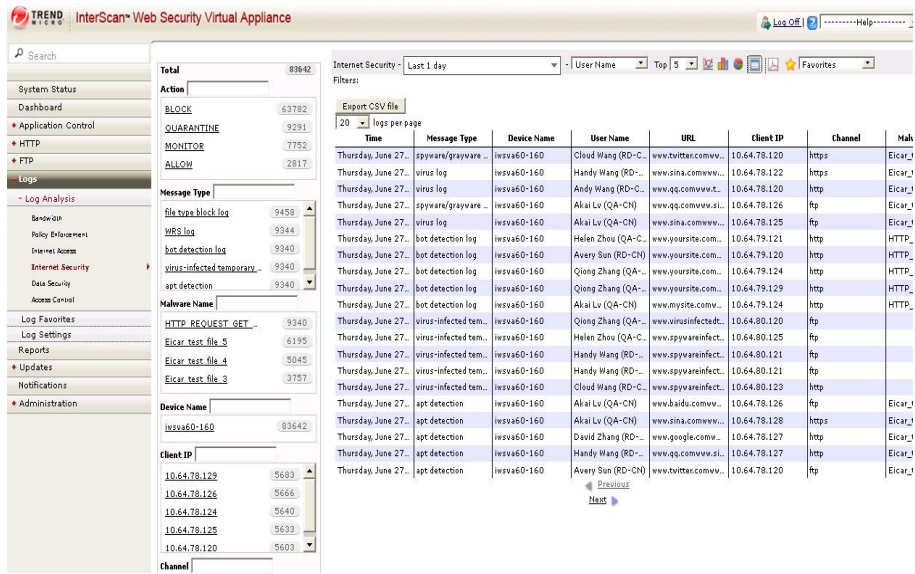

FIGURE 15-4. View the log for HTTPS decryption test in the URL Filtering Log screen if URL filtering is disabled



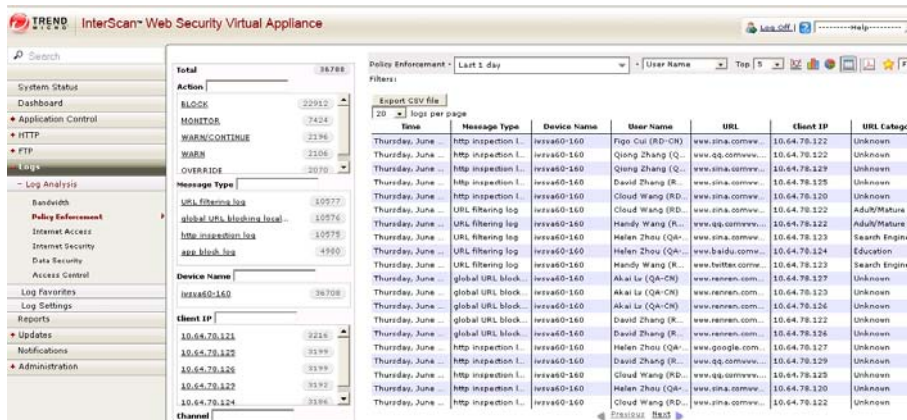

FIGURE 15-5. View the log for HTTPS decryption test in the Internet Security log screen if URL filtering is enabled

## Testing FTP Scanning

The following procedure contains instructions to test your FTP virus scanning capability in standalone mode.

### To test virus scanning of FTP traffic:

1. Download the test virus from the following page:

[http://www.eicar.org/anti\\_virus\\_test\\_file.htm](http://www.eicar.org/anti_virus_test_file.htm)

2. Access the FTP server through IWSVA with it working as the FTP proxy. For example, assume the following IP addresses: IWSVA FTP proxy server (10.2.203.126), FTP server (10.2.202.168).

Open a command line prompt and type the following:

```
ftp 10.2.203.126
```

3. Log on as user@host. For example, if your FTP account name is anonymous and the IP address of the FTP server is 10.2.202.168, then log on as anonymous@10.2.202.168

4. Upload the test virus (for example, eicar\_com.zip) by typing the following command:  

```
put eicar_com.zip
```
5. If you have configured the IWSVA FTP proxy mode correctly, IWSVA displays a message similar to the one in [Figure 15-6](#).

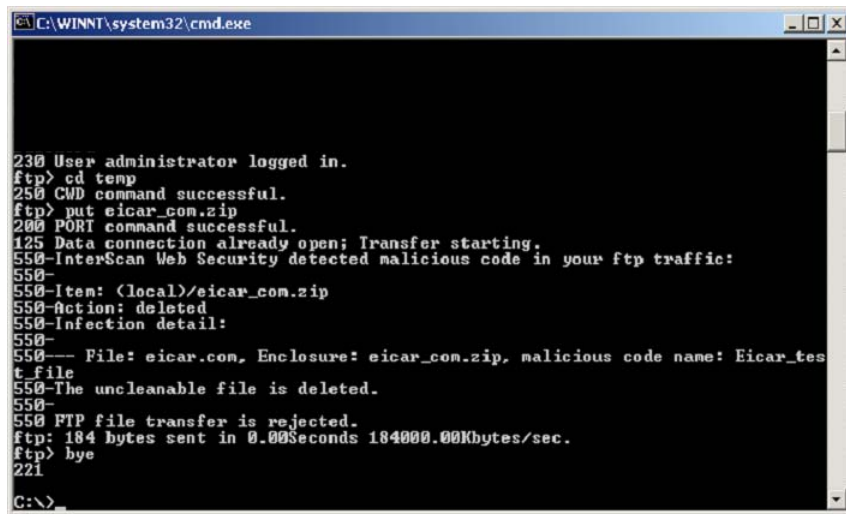

```
C:\WINNT\system32\cmd.exe

230 User administrator logged in.
ftp> cd temp
250 CWD command successful.
ftp> put eicar_com.zip
200 PORT command successful.
125 Data connection already open; Transfer starting.
550-InterScan Web Security detected malicious code in your ftp traffic:
550-
550-Item: (local)/eicar_com.zip
550-Action: deleted
550-Infection detail:
550-
550-File: eicar.com, Enclosure: eicar_com.zip, malicious code name: Eicar_test_file
550-The uncleanable file is deleted.
550-
550-FTP file transfer is rejected.
ftp: 184 bytes sent in 0.00Seconds 184000.00Kbytes/sec.
ftp> bye
221
C:\>
```

FIGURE 15-6. Warning message that shows the detection of a virus in eicar\_com.zip.

## Testing Application Control

IWSVA must be deployed in Transparent Bridge Mode or Transparent Bridge Mode-High Availability to use the Application Control feature.

The following procedure allows you to modify the Application Control Global Policy to block end users from accessing the Google website.

### To test Application Control:

1. Open the IWSVA console and go to **Application Control > Policies**.
2. Check the **Enable Application Control** check box and click **Save**.

3. Click the **Application Control Global Policy** name to modify it.
4. Search for Google protocol listings in one of two ways:
  - a. Type “Google” in the Application Category search field.  
Search result appear listing “Google” in the Web category.
  - b. Scroll down to the Website category, expand the category, and find the entry for Google.
5. Select the **Block** action from the drop-down action menu in the column on the right side of the Website category name.
6. Select one of the objects in scheduled times under “Scheduling.”
7. Click **Apply**.
8. Click **Save** and you return to the Application Control Policies page.
9. Click **Deploy Policies** to deploy the updated policy.
10. Open your browser and attempt to access <http://www.google.com>.  
Your browser displays a notification message confirming an Application Control policy breach.

### Trend Micro InterScan Web Security Event

**Application Control Blocked**

Access to this web site was blocked by an IT Application Control policy.

**Event Details:**

User:	10.64.44.135
IP:	10.64.44.135
Protocol:	Google
Category:	Website
Rule:	Application Control Global Policy
Date:	2013-04-10 04:07:38

If you believe this URL was blocked in error, please contact your IT staff to resolve this issue.

Trend Micro InterScan Web Security Virtual Appliance: IWSVA6-85

## Testing HTTP Inspection

Use this procedure to test the HTTP Inspection browser-type filter which identifies requests sent from a FireFox browser according.

### To test HTTP Inspection:

1. Open the IWSVA console and go to **HTTP > HTTP Inspection > Policies**.
2. Check the **Enable HTTP Inspection** check box and click **Save**.
3. Click the **HTTP Inspection Global Policy** name to access the policy for modification.
4. Select the **Block** action from the drop-down action menu above the list of HTTP Inspection filters.
5. Select one of the objects in scheduled times under “Scheduling.”
6. Click **Apply**.
7. Click **Save** and you return to the HTTP Inspection Policies page.
8. Click **Deploy Policies** to deploy the updated policy.
9. Attempt to access an http:// URL, such as <http://www.google.com>, with your FireFox browser. Your browser displays the notification message in [Figure 15-7](#).



FIGURE 15-7. HTTP Inspection Policy Breach Notification

## Testing URL Monitoring

Before testing the monitor feature in URL filtering, require your users to set the Web client's HTTP proxy to point to IWSVA.

### To test URL filtering:

1. Open the IWSVA Web console and click **HTTP > Configuration > Custom Categories** and create a new category “monitor” for the following URL:  
http://www.download.com
2. Click **HTTP > URL Filtering > Policies** and select **Enable URL Filtering**; then, click the **URL Filtering Global Policy** name to access the policy for editing it.
3. Select one of the objects in scheduled times under “Scheduling.”

**Note:** Create a time object under **Administration > IWSVA Configuration > Scheduled Times**.

4. Select **Monitor** and click the check box under Action for **Blogs/Web Communications/Search Engines/Portals**; then, click **Apply**.

URL Category		Action During	
		Work Time	Leisure
<input type="checkbox"/> Custom Categories	Monitor <input type="button" value="Apply"/>	<input type="checkbox"/>	<input type="checkbox"/>
monitor		<input type="checkbox"/>	<input type="checkbox"/>
<input type="checkbox"/> Network Bandwidth	Allow <input type="button" value="Apply"/>	<input type="checkbox"/>	<input type="checkbox"/>
<input type="checkbox"/> Internet Security	Allow <input type="button" value="Apply"/>	<input type="checkbox"/>	<input type="checkbox"/>
<input type="checkbox"/> Communications and Search	Monitor <input type="button" value="Apply"/>	<input type="checkbox"/>	<input type="checkbox"/>
Blogs/Web Communications	<input type="checkbox"/>	<input checked="" type="checkbox"/>	<input type="checkbox"/>
Chat/Instant Messaging	<input type="checkbox"/>	<input checked="" type="checkbox"/>	<input checked="" type="checkbox"/>
Email	<input type="checkbox"/>	<input checked="" type="checkbox"/>	<input checked="" type="checkbox"/>
Internet Infrastructure	<input type="checkbox"/>	<input checked="" type="checkbox"/>	<input checked="" type="checkbox"/>

**FIGURE 15-8.** Rule screen configuration for URL monitor testing

5. Save and deploy this policy.

6. From a client computer, access the following Web sites during a time you have not selected as the time object:

`http://www.download.com`

`http://www.google.com`

`http://www.yahoo.com`

You should be able to access the Web sites without seeing any warning messages. To query and view URL filtering log, access the IWSVA Web console and click **Logs > Log Analysis > Internet Security**.

## Testing Download Scanning

To test virus scanning when downloading using HTTP or FTP over HTTP, attempt to download the test virus from the following Web site:

[http://www.eicar.org/anti\\_virus\\_test\\_file.htm](http://www.eicar.org/anti_virus_test_file.htm)



**FIGURE 15-9.** This virus-warning screen opens if the system is set up properly.

If a client attempts to download an infected file, IWSVA blocks all other users' access to that site for four hours by default. When other clients subsequently attempt to access the same URL that contained the virus, they will see a URL blocking message instead of the virus-warning message.

Configure the default block time (in hours) by changing the parameter `infected_url_block_length` under the `[Scan-configuration]` section of the `intscan.ini` file.

## Testing URL Filtering

Trend Micro recommends that you use the default settings to test URL filtering.

### To test URL Filtering:

1. Click **HTTP > URL Filtering > Settings** from the main menu. Configure the work days and times.
2. Click **HTTP > URL Filtering > Policies** from the Main menu.
3. Select **Enable URL filtering** and then click **Save**.
4. Click **URL Filtering Global Policy** and select the Block action to apply to the categories that you want blocked during the time you selected.  
Keep the default settings in the Safe Search and Exception tabs.
5. Click **Save** to save any changes. Click **Deploy Policies** to make the policy effective immediately.
6. Open a browser and access any site that is in a category to be blocked at the time of the test. IWSVA blocks access to URLs belonging to the category that is set to be blocked.

## Testing Spyware Scanning

### To test spyware scanning:

1. Click **HTTP > Advanced Threat Protection > Policies**.
2. Click **Virus Scan Global Policy**.
3. Click the **Spyware/Grayware Scan Rule** tab and then select the types of spyware/grayware that should be scanned.
4. Click **Save**.
5. Click **Virus Scan Global Policy**.
6. Click the **Action** tab.

7. Under the **Uncleanable files** field, select the action setting (Delete, Quarantine, or Pass).
8. Click **Save**.
9. Click **Deploy Policies** to make the policy effective immediately.

After a successful spyware detection, a sample message appears:



**FIGURE 15-10. A sample message after detecting a spyware with action “Delete” setting**

## Testing Java Applet and ActiveX Scanning

Java applets and ActiveX controls are used on many Web pages to display interactive content or applications. One way to test IWSVA is to temporarily configure the global policy to block all applets and ActiveX controls, and then attempt to open Web pages that use them (to verify that the applet or object is blocked).

### To test Java applet and ActiveX scanning:

1. Click **HTTP > Applets and ActiveX > Policies** from the main menu.
2. If necessary, select **Enable Applet/ActiveX security** and click **Save**.
3. Click **Applet/ActiveX Security Global Policy**.
4. On the **Java Applet Security Rules** tab, click **Block all Java applets** and then **Save**.
5. On the **ActiveX Security Rules** tab, click **Block all cabinet files** and **Block all PE format files** and then click **Save**.



6. From the **Applets and ActiveX Policies** screen, select **Deploy Policies** to make policy changes effective immediately.
7. Open a Web browser and attempt to navigate to Web sites that use Java applets and ActiveX controls, for example, for stock price tickers or games.  
IWSVA blocks the mobile code from downloading and running in your browser.

---

**Note:** Blocking all Java applets and ActiveX controls might be too restrictive for your environment because it prevents many legitimate Web sites from functioning properly. After testing, Trend Micro recommends going back to the **Applets and ActiveX Policy: Edit Global Policy** screen to change the settings back to the default or your own less-restrictive configuration.

---

## Additional IWSVA Configurations

This section briefly introduces some common IWSVA configuration tasks.

### Configuring the Separate Management Interface

In many large enterprises and/or secure networking environments, a separate network segment (also known as the management network) can be used to manage various network devices. For security reasons, the management network is not connected to the Internet and is a separate network that ordinary users are not allowed to access.

On the IWSVA server, you can enable the separate management interface that connects to the company's management network. A separate network interface must be available on the IWSVA server for the dedicate management interface. After the management

interface is activated and configured on IWSVA, you can access the IWSVA Web console or CLI through the separate management interface. The following shows an example network topology:

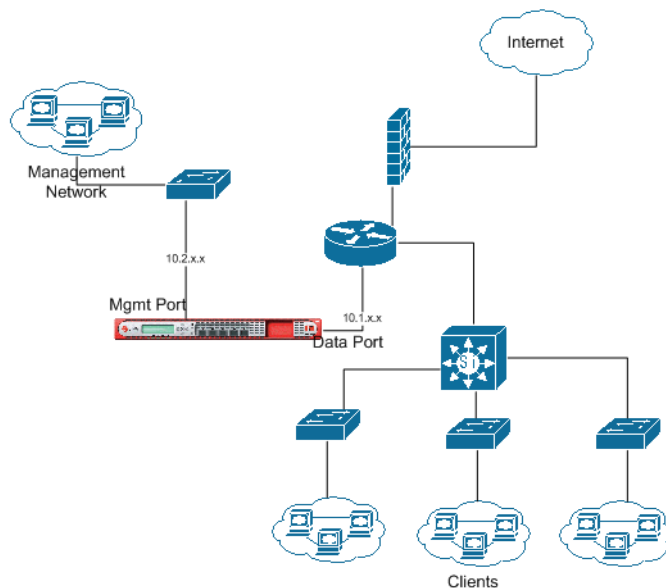

**FIGURE 15-11. IWSVA management interface placement in the network**

In this example, the management interface on the IWSVA is connected to the management network in the company. The clients access the Internet through the data (bridge or proxy) interface.

---

**WARNING!** Do not configure the data (bridge/proxy) interface and the management interface in the same network environment.

---

**To configure the separate management interface:**

1. From the main menu, click the **Administration > Deployment Wizard > Network Interface** page and check the **Separate Management Interface** check box.
2. From the **Ethernet interface** drop-down list, select a desired interface for the management interface.
3. Configure the IP address settings.
4. Select **Enable PING** if you want IWSVA to respond to PING requests on this interface.
5. Click **Save**. You can access the separate management interface to log into the Web console and manage IWSVA.

---

**Tip:** If the IWSVA machine is behind a router/switch in the management network, configure a static route on the management interface to access IWSVA through the Web console or SSH.

---

**To test the separate management interface:**

1. First try to log on to the Web console through the data (bridge or proxy) interface. You should be able to log on and manage IWSVA.
2. Next try accessing the Web console on the separate management interface. You should be able to log on and manage IWSVA.

## Securing the IWSVA Console

By default, the IWSVA Web management console (GUI) is accessed through an HTTP connection on port 1812. For improved security, Trend Micro recommends that you use a Secure Socket Layer connection (HTTPS). You will need to provide a public key and certificate.

**To connect to the IWSVA Web console through HTTPS:**

1. From the main menu, click **Administration > Network Configuration > Web Console** and choose **SSL Mode** to enable a secure connection to the IWSVA console.
2. In the **SSL Certificate** field, click **Browse** to locate the certificate you will use, and then **Upload** to import it to the IWSVA device.

3. Type the password associated with the SSL certificate, if any.
4. Type the port on which you would like to open the IWSVA console and then click **Save**.

For example:

```
https://<IWSVA device IP address:port>
```

---

**Note:** **Non-SSL mode** is the default; use it to access the IWSVA console using a non-secure URL; for example:

```
http://<IWSVA device IP address:port>
```

The default non-secure port is 1812; you can change it to any unused port (recognized by the firewall).

---

## Activating Remote CLI

You can enable the remote CLI feature to connect to the IWSVA server and configure settings using the CLI commands. Remote connection is secured through SSH v2 (Secure Shell) which is a network protocol that allows two network devices to exchange data in a secured connection. SSH replaces Telnet which sends data (including passwords) in clear text.

### To enable remote CLI on the IWSVA server:

1. From the main menu, click **Administration > Network Configuration > Remote CLI** and choose **SSH: Command line access** to enable remote CLI access using SSH on IWSVA.
2. Type the service port number for SSH v2. The default port number is 22.
3. Click **Save**.

## Specifying Advanced Threat Protection Scans

Advanced Threat Protection scanning is enabled by default. The HTTP traffic flow for clients to browse the Web and perform other HTTP operations can be enabled or disabled (see [Enabling the HTTP/HTTPS Traffic Flow on page 6-2](#)).

## Specifying the User Identification Method

IWSVA supports several methods to identify clients when configuring a policy's scope (see [Configuring the User Identification Method on page 7-6](#)). The default identification method is through the client's IP address. IWSVA also supports identifying clients through their host names or MAC addresses and through their LDAP directories.

## Enabling the Guest Account (LDAP only)

When using the **User/group name authentication** identification method, all virus scanning, Java applets and ActiveX security, URL filtering, and access quota policies will support configuring policies for users who are temporarily visiting your network. The guest account is disabled by default—enable it to allow guests accounts to access the Internet. To enable the guest account, IWSVA needs to be configured for User/Group name authentication (LDAP).

### To enable guest accounts:

1. To enable the guest account, go to **Administration > IWSVA Configuration < User Identification tab**.
2. In the **Authentication Method** section, select **Captive Portal**, check **Allow Guest Login**, and click **Save**.

## Reviewing Scanning and Filtering Policies

IWSVA is pre-configured to provide a baseline level of gateway security. Trend Micro recommends reviewing the HTTP virus scanning Global and Guest policy configurations to ensure they reflect your organization's security policies.

Additionally, if you are running the Applets and ActiveX security, URL filtering and FTP scanning modules, review those configurations and modify them accordingly.

## Enabling Access Quota Policies

To limit bandwidth consumption, enable the access quota control to set a maximum amount of data that a client can retrieve or download during a given time period.

**To enable access quota control:**

1. Click **HTTP > Access Quota Policies** on the main menu.
2. Select **Enable access quota control**.
3. To configure access quota control for your network's guest users, click **Access Quota Policies** and configure the settings. To configure access quota control for other network users, click **Add** and configure a new policy.
4. Click **Save**.  
For the new policy to take effect immediately, click **Deploy Policies** in the **HTTP > Access Quota Policies** page.

## Setting Internet Access Control Settings

The default IWSVA settings allow all non-guest clients to access the Internet. To allow a subset of your clients Internet access, configure their IP addresses on the **Access Control Settings** screen.

In addition, IWSVA can be configured to exempt some servers from scanning, URL filtering, and URL blocking to speed up browsing performance when visiting trusted sites. For example, consider adding the IP address ranges of your intranet sites to the Approved Server IP list to exempt frequently visited sites from scanning and filtering.

**To configure which clients are allowed to access the Internet:**

1. Click **HTTP > Configuration > Access Control Settings** from the main menu.
2. On the **Client IP** tab, select **Enable HTTP Access Based On Client IP** and enter the IP/Hostname addresses that are allowed to access the Internet.
3. Enter a short description.
4. Click **Add**.
5. Click **Save**.

**To configure which servers are exempt from filtering and scanning:**

1. Click **HTTP > Configuration > Access Control Settings** from the main menu.
2. Click the **Approved Server IP List** tab, configure the IP/Hostname addresses of servers that are exempt from scanning, URL filtering, and URL blocking.
3. Enter a short description.

4. Click **Add**.
5. Click **Save**.

## Adding System Updates or Removing an Application Patch

From time to time, Trend Micro makes updates available through the Download Center. After downloading the latest update from the Download Center to a desktop or other computer, you can upload it to the IWSVA device where it is automatically installed.

### To add a system update:

1. Download the latest update from <http://downloadcenter.trendmicro.com>
2. From the main menu, click **Administration > System Updates** and then click **Browse**.
3. Locate the update you downloaded from the Trend Micro Download Center.
4. Click **Upload** to have IWSVA copy the update to the IWSVA device and begin installing.

Only a properly formatted and encrypted Trend Micro patch can be uploaded from this utility.

### To remove an application patch:

1. From the main menu, click **Administration > System Updates**.
2. In the History section, click the **Application Patches** tab.
3. Click the **Uninstall** link beside the application patch number.
4. In the preview page that appears, verify the version of the patch you want to remove.

You can remove the most recently installed application patch at any time.

5. Click **Uninstall**. A progress page appears. After the patch has been removed, close the window to return to the main IWSVA console.

## About Hot Fixes, Patches, and Service Packs

After an official product release, Trend Micro often develops hot fixes, patches, and service packs to address issues, enhance product performance, or add new features.

The following is a summary of the items Trend Micro might release:

- **Hot fix:** A workaround or solution to a single customer-reported issue. Hot fixes are issue-specific, and therefore, not released to all customers. Windows hot fixes include a setup program.
- **Security Patch:** A hot fix focusing on security issues that is suitable for deployment to all customers.
- **Patch:** A group of hot fixes and security patches that solve multiple program issues. Trend Micro makes patches available on a regular basis.
- **Service Pack:** A consolidation of hot fixes, patches, and feature enhancements significant enough to be considered a product upgrade. You can obtain hot fixes from your Technical Account Manager. Check the Trend Micro Knowledge Base to search for released hot fixes:
  - <http://esupport.trendmicro.com/support/>

Check the Trend Micro Web site regularly to download patches and service packs:

- <http://www.trendmicro.com/download>

All releases include a readme file with the information you need to install, deploy, and configure your product. Read the readme file carefully before installing the hot fix, patch, or service pack file(s).

## Checking the Database Connection

When you are setting up a database for multiple IWSVA configurations, specify the same database for all IWSVA devices.

### To check the database connection settings:

1. Click **Administration > IWSVA Configuration > Database Connection**.
2. Under **Policy Database Connection Settings**, view the database settings.
3. Click **Test Database Connection**.

Policy settings are stored in the database, and IWSVA copies the settings to a memory cache. IWSVA reloads the settings from the database into memory according to the Policy Deployment Settings (in minutes) option that specifies the interval.



**To configure the Policy Deployment Settings (in minutes):**

1. Open the IWSVA Web console and click **Administration > IWSVA Configuration > Policy Deployment**.
2. Under **Policy Deployment Settings (in minutes)**, type a value for the following parameters:
  - Virus scan policy
  - HTTPS policy
  - Applet and ActiveX policy
  - HTTP inspection policy
  - URL filtering policy
  - Access quota policy
  - Application Control policy
  - DLP policy
3. Click **Save**.

## Changing the Management Console Password

The Web console password is the primary means to protect your IWSVA device from unauthorized changes. For a more secure environment, change the console password on a regular basis and use a password that is difficult to guess.

The administrator passwords can be changed through the Web console interface. The CLI allows you to change the Enable, Root, and any Administrator account passwords. The CLI command uses the “configure password” command to make the changes.

**To change the Web console password through the CLI:**

1. Log in to the CLI console as “enable.”
2. Type the following command:  
`configure system password`

The following tips help you design a safe password:

- Include both letters and numbers in your password
- Avoid words found in any dictionary, of any language
- Intentionally misspell words

- Use phrases or combine words
- Use both uppercase and lowercase letters

**To change the Web console password:**

1. Open the IWSVA console and click **Administration > Management Console > Account Administration** in the main menu.
2. Click the user account for which you want to change the password.
3. From the Login Accounts page, type the new password in the **Password** field and then again in the **Confirm Password** field.
4. Click **Save**.

## Configurations After Changing the Web Console Listening Port

When users enable the HTTPS Web console management mode by accessing the **Administration > Network Configuration > Web Console** screen and setting the **Port number** for SSL mode to a port (such as 8443) not used by other applications, they should also specify this SSL management port number in the **HTTP > Configuration > Access Control Settings** screen as well.

If this port number is not specified in the **Access Control Settings** screen, the consequence could be that the IWSVA progress page is blocked by IWSVA itself, when using the HTTPS Web console. In other words, when clients try to access URLs, they would see the progress bar blocked by IWSVA.

## Verifying URL Filtering Settings

If you are running the URL filtering module, review the post-install tasks that follow to prepare IWSVA for your environment.

IWSVA accesses the Web Reputation database that contains URLs in over 80 categories, such as “gambling,” “games,” and “personals/dating.” These categories are contained in logical groups.

Trend Micro recommends reviewing the URL filtering settings to ensure that the categories that qualify as company-prohibited sites reflect the values of your organization and do not affect your employees’ business-related Web browsing. Before rolling out URL filtering policies, Trend Micro recommends verifying that the default

categorizations are appropriate for your organization. For example, a clothing retailer might need to remove a swimsuit Web site from the “Intimate Apparel/Swimsuit” category located in the *Adult* group in order to allow legitimate market and competitor research.

Additionally, you might need to configure URL exceptions to enable employee access to specific sites that would otherwise be blocked, and review the definitions of “work time” to ensure it reflects your workplace schedule.

**To review URL filtering settings:**

1. Click **HTTP > URL Filtering > Policies > Policy > Exceptions** from the main menu.
2. Choose an approved URL list from the drop-down list that contains the Web sites that will be exempt from URL filtering so that they are always accessible to your clients.
3. Click **Save**.
4. Click **Administration > IWSVA Configuration > Scheduled Times** on the main menu.

---

**Note:** The default setting for “work time” is Monday to Friday, from 08:00 to 12:00, and from 13:00 to 17:00.

---

5. Modify these time settings according to the employee schedules in your workplace.
6. Click **HTTP > URL Filtering > Policies** from the main menu and review the category settings of the URL Filtering Guest Policy and URL Filtering Global Policy.

## IWSVA Performance Tuning

If you are experiencing issues with slow browsing performance, consider the modifications described in the following section.

## LDAP Performance Tuning

When running IWSVA to use the user/group name authentication identification method (LDAP), HTTP proxy performance becomes dependent upon the responsiveness of the LDAP directory server. In a worst case scenario, every HTTP request would require an LDAP query to authenticate the user's credentials, and another to retrieve group membership information for that user. These queries introduce latency in terms of the transmit/receive delay between IWSVA and the LDAP server, and add load to the LDAP server itself.

## LDAP Internal Caches

To reduce the amount of LDAP queries required, IWSVA provides several internal caches:

- **User group membership cache:** This cache can store the group membership information for several hundred users. By default, entries in this cache are valid for 48 hours, or until the cache fills (at which point entries are replaced, starting with the oldest). The time to live (TTL) for entries in this cache can be configured through the `user_groups_central_cache_interval` setting in the `[user-identification]` section of the `intscan.ini` configuration file.
- **Client IP to User ID cache:** This cache associates a client IP address with a user who recently authenticated from that same IP address. Any request originating from the same IP address as a previously authenticated request is attributed to that user, provided the new request is issued within a configurable window of time (15 minutes by default for HTTP, 90 minutes for ICAP) from that authentication. The caveat is that client IP addresses recognized by IWSVA must be unique to a user within that time period; therefore, this cache is not useful in environments where there is a proxy server or source NAT between the clients and IWSVA, or where DHCP frequently reassigns client IPs. To enable or disable this cache, change the `enable_ip_user_cache` setting in the `[user-identification]` section of the `intscan.ini` configuration file. To change the TTL of this cache, change the `ip_user_central_cache_interval` (unit is hours). For example, to create a TTL of 30 minutes, enter "0.5".
- **User authentication cache:** This avoids re-authenticating multiple HTTP requests passed over a persistent connection. When users pass the credential validation over a persistent connection, IWSVA adds an entry (two important keys in one cache entry are the client's IP address and the client's user name) in the user authentication

cache so the subsequent requests over a keep-alive connection does not authenticate again. The client's IP address and client's user name serve as two forward references, or links, to the "client IP to user ID cache" and "user group membership cache," respectively. IWSVA is still able to retrieve the user's connection information from both the IP-user and user-group caches.

When deploying IWSVA with LDAP integration, it is important to consider the additional load that authenticating HTTP requests places on the LDAP directory server. In an environment that cannot effectively use the client IP to user ID cache, the directory server needs to be able to handle queries at the same rate IWSVA receives HTTP requests.

## Disable Verbose Logging When LDAP Enabled

Trend Micro recommends turning off verbose logging in the `intscan.ini` file, under the `[http]` section, "verbose" parameter, when LDAP is enabled for server performance reasons. Verbose logging is primarily used by software developers to identify abnormal application behavior and troubleshooting. In a production deployment, verbose logging is usually unnecessary.

If verbose logging is enabled and LDAP is also enabled, IWSVA logs user authentication information and group membership information in the HTTP log in the Log folder. Logs might contain hundreds of lines per user and, therefore, significantly consume disk space, depending on the amount of internal traffic and the number of groups with which a user is associated. Verbose logging keeps the service busy by issuing I/O operations to the operating system. This might prevent the service from responding to HTTP requests in a timely fashion, and latency might occur. In an extreme bursting HTTP traffic environment, it's possible to observe significant delays when IWSVA starts up in the verbose mode.



# Appendix A

## Contact Information and Web-based Resources

This appendix provides information to optimize the InterScan Web Security Virtual Appliance (IWSVA) performance and get further assistance with any technical support questions you might have.

Topics in this appendix include:

- [Contacting Technical Support on page A-2](#)
- [IWSVA Core Files for Support on page A-2](#)
- [Knowledge Base on page A-3](#)
- [Sending Suspicious Code to Trend Micro on page A-3](#)
- [TrendLabs on page A-4](#)
- [Security Information Center on page A-5](#)
- [TrendEdge on page A-7](#)

## Contacting Technical Support

In the United States, Trend Micro representatives can be reached through phone, fax, or email. Our Web site and email addresses are as follows:

<http://www.trendmicro.com>  
[http://esupport.trendmicro.com/  
support@trendmicro.com](http://esupport.trendmicro.com/support@trendmicro.com)

General US phone and fax numbers are as follows:

Voice: +1 (408) 257-1500 (main)

Fax: +1 (408) 257-2003

Our US headquarters are located in the heart of Silicon Valley:

Trend Micro, Inc.  
10101 N. De Anza Blvd.  
Cupertino, CA 95014

To obtain Trend Micro contact information for your region/country, please visit <http://www.trendmicro.com>

## IWSVA Core Files for Support

IWSVA generates a core file containing the system data held in memory when a process is abnormally terminated.

Raw core files are created in the `var/iwss/coredumps` directory on the IWSVA device. They are then compressed and moved to `/var/iwss/UserDumps`. You can use these files when working with Trend Micro technical support to help diagnose the cause of the problem.

### To access the core files:

1. From the main IWSVA menu, click **Administration > Support**.
2. On the System Information Files tab, click **Generate System Information File**.
3. Select the Core or System File(s). (Hold down the Ctrl key to select multiple files).
4. Download the file to your computer, or delete it.



---

**Note:** To inspect the files yourself, use a program such as GDB, the GNU Project debugger.

---

## Knowledge Base

The Trend Micro Knowledge Base is a 24x7 online resource that contains thousands of do-it-yourself technical support procedures for Trend Micro products. Use Knowledge Base, for example, if you are getting an error message and want to find out what to do to. New solutions are added daily.

Also available in Knowledge Base are product FAQs, hot tips, preventive antivirus advice, and regional contact information for support and sales.

<http://esupport.trendmicro.com/>

And, if you can't find an answer to a particular question, the Knowledge Base includes an additional service that allows you to submit your question through an email message. Response time is typically 24 hours or less.

## Sending Suspicious Code to Trend Micro

You can send your viruses, infected files, Trojans, suspected worms, spyware, and other suspicious files to Trend Micro for evaluation. To do so, visit the Trend Micro Submission Wizard URL:

<http://esupport.trendmicro.com/en-us/business/pages/virus-and-threat-removal.aspx>

Click the “Submit a suspicious file/undetected virus” link.

You are prompted to supply the following information:

- **Email:** Your email address where you would like to receive a response from the antivirus team.
- **Product:** The product you are currently using. If you are using multiple Trend Micro products, select the product that has the most effect on the problem submitted, or the product that is most commonly in use.
- **Number of Infected Seats:** The number of users in your organization that are infected.

- **Upload File:** Trend Micro recommends that you create a password-protected zip file of the suspicious file, using the word “virus” as the password—then select the protected zip file in the **Upload File** field.
- **Description:** Please include a brief description of the symptoms you are experiencing. Our team of virus engineers “dissect” the file to identify and characterize any risks it might contain and return the cleaned file to you, usually within 48 hours.

---

**Note:** Submissions made through the submission wizard/virus doctor are addressed promptly and are not subject to the policies and restrictions set forth as part of the Trend Micro Virus Response Service Level Agreement.

---

When you click **Next**, an acknowledgement screen opens. This screen also displays a Tracking Number for the problem you submitted.

If you prefer to communicate by email, send a query to the following address:

[virusresponse@trendmicro.com](mailto:virusresponse@trendmicro.com)

In the United States, you can also call the following toll-free telephone number:

(877) TRENDAY, or 877-873-6328

## TrendLabs

TrendLabs is Trend Micro’s global infrastructure of antivirus research and product support centers that provide customers with up-to-the minute security information.

The “virus doctors” at TrendLabs monitor potential security risks around the world, to ensure that Trend Micro products remain secure against emerging risks. The daily culmination of these efforts are shared with customers through frequent virus pattern file updates and scan engine refinements.

TrendLabs is staffed by a team of several hundred engineers and certified support personnel that provide a wide range of product and technical support services. Dedicated service centers and rapid-response teams are located in Tokyo, Manila, Taipei, Munich, Paris, and Lake Forest, CA.

## Security Information Center

Comprehensive security information is available over the Internet, free of charge, on the Trend Micro Security Information Web site:

<http://www.trendmicro.com/vinfo/>

Visit the Security Information site to:

- Read the Weekly Virus Report, which includes a listing of risks expected to trigger in the current week, and describes the 10 most prevalent risks around the globe for the current week
- View a [Malware Map](#) of the top 10 risks around the globe



FIGURE A-1. Trend Micro World Virus Tracking Program virus map

- Consult the Threat Encyclopedia, a compilation of known risks including risk rating, symptoms of infection, susceptible platforms, damage routine, and instructions on how to remove the risk, as well as information about computer hoaxes

- Download test files from the European Institute of Computer Anti-virus Research (EICAR), to help you test whether your security product is correctly configured
- Read general virus information, such as:
  - The Virus Primer, which helps you understand the difference between viruses, Trojans, worms, and other risks
  - The Trend Micro *Safe Computing Guide*
  - A description of risk ratings to help you understand the damage potential for a risk rated Very Low or Low vs. Medium or High risk
  - A glossary of virus and other security risk terminology
- Download comprehensive industry white paper
- See the Threat Meter or search the Threat Encyclopedia



**FIGURE A-2. Trend Micro Threat Information**

- Subscribe, free, to Trend Micro's Virus Alert service, to learn about outbreaks as they happen, and the Weekly Virus Report
- Learn about free virus update tools available to Webmasters

**To open Security Information:**

1. Open the IWSVA Web console.
2. Click **Security Info** from the drop-down menu at the top-right panel of the screen. The **Threat Encyclopedia** screen opens.

## TrendEdge

A program for Trend Micro employees, partners, and other interested parties that provides information on unsupported, innovative techniques, tools, and best practices for Trend Micro products. The TrendEdge database contains numerous documents covering a wide range of topics.

<http://trendedge.trendmicro.com>



## Appendix B

### Mapping File Types to MIME Content-types

The following table describes some of the file types that you can enter in the HTTP and FTP virus scanning policy **MIME content-type to skip** field to skip scanning of the corresponding MIME content-types.

- [Overview on page B-2](#)
- [File Type Mapping Table for MIME Content Files on page B-4](#)

## Overview

Potential MIME names are not limited to [Table B-1](#), which means you can input any name into the IWSVA UI skip list. (See [To select which file types to scan: on page 8-54](#) for details.) However, the MIME type can only be skipped under the following dependencies:

IWSVA receives a file and determines:

- Is the MIME name is set to be skipped on the UI
- Is the file type (not the MIME name) is listed in the mapping table:
- If the MIME name is in the mapping tables, is MIME name is on the UI skip list?

If IWSVA finds a match, it can be skipped. If IWSVA cannot find a match, it will not be skipped.

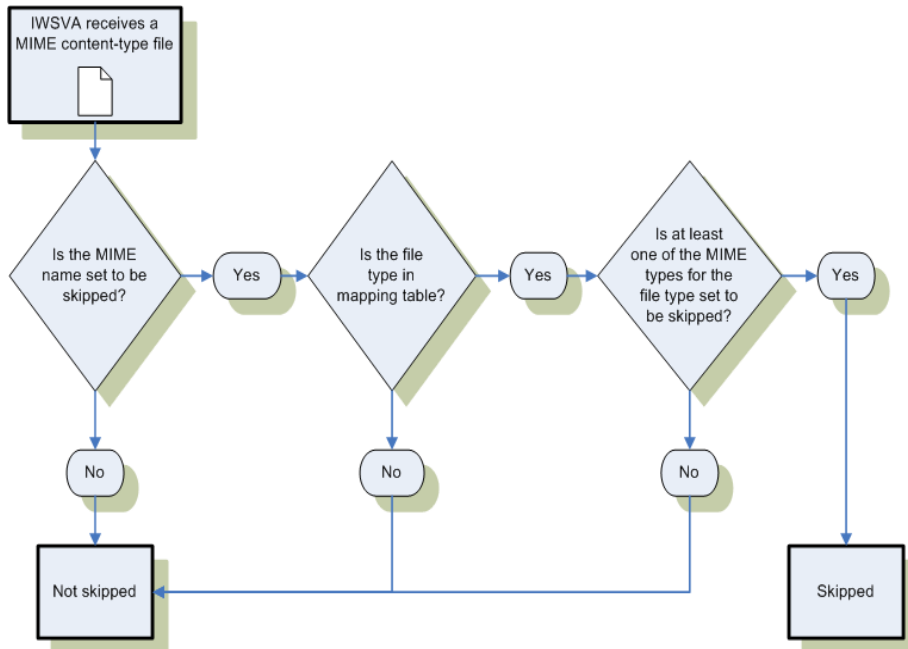

**FIGURE B-1. MIME Content Type Flow for Skipped Files**



If an admin inputs a MIME name and the file type is unknown to IWSVA, IWSVA will skip the scanning of that file. If a MIME type is set to be skipped in IWSVA and it does not exist in the file type-MIME table, scanning will be skipped because the file type-MIME table can not list all possible MIME types for all possible file types.

If at least one of the MIME types for a file type is set to be skipped, it will also have scanning skipped because MIME names are not standard. The file type-MIME table can not list all MIME types for an known file type.

For example, the file type-MIME table contains mappings for FLV files: video/flv, video/x-flv: It does not contain “application/flv.” However, some Web sites use “application/flv.” IWSVA will not be able find the mapping entry for it, but IWSVA knows this is an FLV file by performing a file type check. It will skip the scan of this file.

If admin inputs “video/flv” and “application/flv” in skip list, the following check occurs:

- MIME name set to be skipped (MIME type: application/flv) >Yes >
- Check whether file type is in mapping table (file type: flv) > Yes >
- At least one of the MIME types for file type is set to skip >Yes > Skip the scan

## File Type Mapping Table for MIME Content Files

**TABLE B-1. File Type Mapping Table for MIME Content-Files**

<b>FILE TYPE</b>	<b>MIME CONTENT-TYPE</b>
ACE Compression File	application/x-ace
ACE Compression File	application/x-compressed
Apple Sound	audio/aiff
Apple Sound	audio/x-aiff
Audio InterChange File Format from Apple/SGI	audio/aiff
Audio InterChange File Format from Apple/SGI	audio/x-aiff
Audio InterChange File Format from Apple/SGI	sound/aiff
Audio InterChange File Format from Apple/SGI	audio/rmf
Audio InterChange File Format from Apple/SGI	audio/x-rmf
Audio InterChange File Format from Apple/SGI	audio/x-pn-aiff
Audio InterChange File Format from Apple/SGI	audio/x-gsm
Audio InterChange File Format from Apple/SGI	audio/x-midi
Audio InterChange File Format from Apple/SGI	audio/vnd.qcelp
ARJ	application/arj

**TABLE B-1. File Type Mapping Table for MIME Content-Files (Continued)**

<b>FILE TYPE</b>	<b>MIME CONTENT-TYPE</b>
ARJ	application/x-arj
ARJ	application/x-compress
ARJ	application/x-compressed
ARJ	zz-application/zz-winassoc-arj
Advanced Streaming Format	video/x-ms-asf
Advanced Streaming Format	video/x-ms-asf-plugin
Advanced Streaming Format	video/x-ms-wm
Advanced Streaming Format	video/x-ms-wmx
Advanced Streaming Format	audio/asf
Advanced Streaming Format	application/asx
Advanced Streaming Format	application/x-mplayer2
Advanced Streaming Format	application/vnd.ms-as"
Nullsoft AVS	video/avs-video
Mime Base 64	application/base64
Macintosh MacBinary Archive	application/mac-binary
Macintosh MacBinary Archive	application/macbinary
Macintosh MacBinary Archive	application/octet-stream
Macintosh MacBinary Archive	application/x-binary
Macintosh MacBinary Archive	application/x-macbinary
BINHEX	application/binhex

**TABLE B-1. File Type Mapping Table for MIME Content-Files (Continued)**

<b>FILE TYPE</b>	<b>MIME CONTENT-TYPE</b>
BINHEX	application/binhex4
BINHEX	application/mac-binhex
BINHEX	application/mac-binhex40
BINHEX	application/x-binhex40
Windows BMP	image/bmp
Windows BMP	image/x-bmp
Windows BMP	image/x-bitmap
Windows BMP	image/x-xbitmap
Windows BMP	image/x-win-bitmap
Windows BMP	image/x-windows-bmp
Windows BMP	image/ms-bmp
Windows BMP	image/x-ms-bmp
SGI Image	image/x-sgi-bw
GNU BZIP2	application/x-bzip2
GNU BZIP3	application/bzip2
GNU BZIP4	application/x-bz2
GNU BZIP5	application/x-compressed
Computer Graphics Metafiles	image/cgm
COM	application/octet-stream
COM	application/x-msdos-program

**TABLE B-1. File Type Mapping Table for MIME Content-Files (Continued)**

<b>FILE TYPE</b>	<b>MIME CONTENT-TYPE</b>
COM	application/x-msdownload
UNIX cpio Archive	application/x-cpio
Macromedia Director Shockwave Movie	application/x-director
WordPerfect	application/wordperfect
AutoCAD DWG	application/acad
AutoCAD DWG	application/x-acad
AutoCAD DWG	drawing/x-dwg
AutoCAD DWG	image/vnd.dwg
AutoCAD DWG	image/x-dwg
Encapsulated Postscript	application/postscript
Encapsulated Postscript	image/x-eps
Encapsulated Postscript	image/eps
Encapsulated Postscript	application/x-eps
Encapsulated Postscript	application/eps
EXE	application/octet-stream
EXE	application/exe
EXE	application/x-msdownload
EXE	application/x-exe
EXE	application/dos-exe

**TABLE B-1. File Type Mapping Table for MIME Content-Files (Continued)**

<b>FILE TYPE</b>	<b>MIME CONTENT-TYPE</b>
EXE	vms/exe
EXE	application/x-winexe
EXE	application/msdos-windows
Free Hand Document	image/x-freehand
AutoDesk Animator (FLI or FLC)	video/x-fli
AutoDesk Animator (FLI or FLC)	video/flc
AutoDesk Animator (FLI or FLC)	video/fli
AutoDesk Animator (FLI or FLC)	video/x-acad-anim
Macromedia Flash FLV Video	video/flv
Macromedia Flash FLV Video	video/x-flv
Macromedia Flash FLV Video	flv-application/octet-stream
Frame Maker	application/vnd.framemaker
GIF	image/gif
GNU ZIP	application/gzip
GNU ZIP	application/x-gzip
GNU ZIP	application/x-gunzip
GNU ZIP	application/gzipped
GNU ZIP	application/gzip-compressed
GNU ZIP	application/x-compressed
GNU ZIP	application/x-compress

**TABLE B-1. File Type Mapping Table for MIME Content-Files (Continued)**

<b>FILE TYPE</b>	<b>MIME CONTENT-TYPE</b>
GNU ZIP	gzip/document
GNU ZIP	encoding/x-gzip
Windows Icon	image/ico
Windows Icon	image/x-icon
Windows Icon	application/ico
Windows Icon	application/x-ico
Windows Icon	application/x-win-bitmap
Windows Icon	image/x-win-bitmap
Amiga 8SVX Audio Interchange File Format	audio/x-aiff
Amiga 9SVX Audio Interchange File Format	image/iff
Amiga 10SVX Audio Interchange File Format	image/x-iff
Amiga 11SVX Audio Interchange File Format	application/iff
JAVA Applet	text/x-java-source
JAVA Applet	application/java-class
JAVA Applet	application/x-java-applet
JAVA Applet	application/x-java-vm
JPEG	image/jpeg
JPEG	image/jpg

**TABLE B-1. File Type Mapping Table for MIME Content-Files (Continued)**

<b>FILE TYPE</b>	<b>MIME CONTENT-TYPE</b>
JPEG	image/jp_
JPEG	image/pipeg
JPEG	image/pjpeg
LHA	application/x-lha
LHA	application/lha
LHA	application/x-compress
LHA	application/x-compressed
LHA	application/maclha
Compiled LISP	application/x-lisp
NT/95 Shortcut (*.lnk)	application/x-ms-shortcut
LightWave 3D Object	image/x-lwo
MAUD Sample Format	audio/x-maud
Microsoft Document Imaging	image/vnd.ms-modi
MIDI	audio/midi
Magick Image File Format	application/x-mif
Multi-image Network Graphics	video/x-mng
Multi-image Network Graphics	video/mng
MP3	audio/mpeg
MP3	audio/mpeg3
MP3	audio/x-mpeg-3



**TABLE B-1. File Type Mapping Table for MIME Content-Files (Continued)**

<b>FILE TYPE</b>	<b>MIME CONTENT-TYPE</b>
MPEG	video/mpeg
MPEG	video/mpg
MPEG	video/x-mpg
MPEG	video/mpeg2
MPEG	video/x-mpeg
MPEG	video/x-mpeg2a
Microsoft Cabinet	application/x-cabinet-win32-x86
Windows Word	application/msword
Windows Word	application/doc
Windows Word	application/vnd.msword
Windows Word	application/vnd.ms-word
Windows Word	application/x-msw6
Windows Word	application/x-msword
Windows Excel	application/excel
Windows Excel	application/x-msexcel
Windows Excel	application/x-ms-excel
Windows Excel	application/x-excel
Windows Excel	application/vnd.ms-excel
Windows Excel	application/xls
Windows Excel	application/x-xls

**TABLE B-1. File Type Mapping Table for MIME Content-Files (Continued)**

<b>FILE TYPE</b>	<b>MIME CONTENT-TYPE</b>
Windows Installer	application/x-ole-storage
Microsoft Access (MDB)	application/x-msaccess
Microsoft Access (MDB)	application/msaccess
Microsoft Access (MDB)	application/vnd.msaccess
Microsoft Access (MDB)	application/vnd.ms-access
Microsoft Access (MDB)	application/mdb
Microsoft Access (MDB)	application/x-mdb
Microsoft Access (MDB)	zz-application/zz-winassoc-mdb
Microsoft Office 12	application/vnd.ms-word.document.macroEnabled.12
Microsoft Office 12	application/vnd.openxmlformats-officedocument.wordprocessingml.document
Microsoft Office 12	application/vnd.ms-word.template.macroEnabled.12
Microsoft Office 12	application/vnd.openxmlformats-officedocument.wordprocessingml.template
Microsoft Office 12	application/vnd.ms-powerpoint.template.macroEnabled.12
Microsoft Office 12	application/vnd.openxmlformats-officedocument.presentationml.template
Microsoft Office 12	application/vnd.ms-powerpoint.addin.macroEnabled.12

**TABLE B-1. File Type Mapping Table for MIME Content-Files (Continued)**

<b>FILE TYPE</b>	<b>MIME CONTENT-TYPE</b>
Microsoft Office 12	application/vnd.ms-powerpoint.slide-show.macroEnabled.12
Microsoft Office 12	application/vnd.openxmlformats-officedocument.presentationml.slideshow
Microsoft Office 12	application/vnd.ms-powerpoint.presentation.macroEnabled.12
Microsoft Office 12	application/vnd.openxmlformats-officedocument.presentationml.presentation
Microsoft Office 12	application/vnd.ms-excel.addin.macroEnabled.12
Microsoft Office 12	application/vnd.ms-excel.sheet.binary.macroEnabled.12
Microsoft Office 12	application/vnd.ms-excel.sheet.macroEnabled.12
Microsoft Office 12	application/vnd.openxmlformats-officedocument.spreadsheetml.sheet
Microsoft Office 12	application/vnd.ms-excel.template.macroEnabled.12
Microsoft Office 12	application/vnd.openxmlformats-officedocument.spreadsheetml.template
Microsoft Office 12	application/vnd.openxmlformats
Windows PowerPoint	application/mspowerpoint

**TABLE B-1. File Type Mapping Table for MIME Content-Files (Continued)**

<b>FILE TYPE</b>	<b>MIME CONTENT-TYPE</b>
Windows PowerPoint	application/powerpoint
Windows PowerPoint	application/vnd.ms-powerpoint
Windows PowerPoint	application/ms-powerpoint
Windows PowerPoint	application/mspowerpnt
Windows PowerPoint	application/vnd-mspowerpoint
Windows PowerPoint	application/x-powerpoint
Windows PowerPoint	application/x-mspowerpoint
Windows Project	application/vnd.ms-project
Windows Project	application/x-msproject
Windows Project	application/x-project
Windows Project	application/msproj
Windows Project	application/msproject
Windows Project	application/x-ms-project
Windows Project	application/x-dos_ms_project
Windows Project	application/mpp
Windows Project	zz-application/zz-winassoc-mpp
Windows Write	application/mswrite
Windows Write	application/x-mswrite
Windows Write	application/wri
Windows Write	application/x-wri

**TABLE B-1. File Type Mapping Table for MIME Content-Files (Continued)**

<b>FILE TYPE</b>	<b>MIME CONTENT-TYPE</b>
Windows Write	application/msword
Windows Write	application/microsoft_word
Windows Write	zz-application/zz-winassoc-wri
Open Document	application/vnd.oasis.opendocument.text
Open Document	application/vnd.oasis.opendocument.text-template
Open Document	application/vnd.oasis.opendocument.graphics
Open Document	application/vnd.oasis.opendocument.graphics-template
Open Document	application/vnd.oasis.opendocument.presentation
Open Document	application/vnd.oasis.opendocument.presentation-template
Open Document	application/vnd.oasis.opendocument.spreadsheet
Open Document	application/vnd.oasis.opendocument.spreadsheet-template
Open Document	application/vnd.oasis.opendocument.chart
Open Document	application/vnd.oasis.opendocument.chart-template
Open Document	application/vnd.oasis.opendocument.image

**TABLE B-1. File Type Mapping Table for MIME Content-Files (Continued)**

<b>FILE TYPE</b>	<b>MIME CONTENT-TYPE</b>
Open Document	application/vnd.oasis.opendocument.image-template
Open Document	application/vnd.oasis.opendocument.formula
Open Document	application/vnd.oasis.opendocument.formula-template
Open Document	application/vnd.oasis.opendocument.text-master
Open Document	application/vnd.oasis.opendocument.text-web
Gravis Patch Files	audio/pat
Gravis Patch Files	audio/x-pat
Microsoft Paint v1.x	image/x-pcx
Microsoft Paint v1.x	image/pcx
Microsoft Paint v1.x	image/x-pc-paintbrush
Microsoft Paint v1.x	application/x-pcx
Microsoft Paint v1.x	application/pcx
Microsoft Paint v1.x	zz-application/zz-winassoc-pcx
Microsoft Paint v2.x	image/x-pcx
Microsoft Paint v2.x	image/pcx
Microsoft Paint v2.x	image/x-pc-paintbrush
Microsoft Paint v2.x	application/x-pcx

**TABLE B-1. File Type Mapping Table for MIME Content-Files (Continued)**

<b>FILE TYPE</b>	<b>MIME CONTENT-TYPE</b>
Microsoft Paint v2.x	application/pcx
Microsoft Paint v2.x	zz-application/zz-winassoc-pcx
PCX	image/x-pcx
PCX	image/pcx
PCX	image/x-pc-paintbrush
PCX	application/x-pcx
PCX	application/pcx
PCX	zz-application/zz-winassoc-pcx
Palm Pilot Image	application/x-pilot-pdb
Adobe Portable Document Format (PDF)	application/pdf
Adobe Portable Document Format (PDF)	application/x-pdf
Adobe Font File	application/x-font
Macintosh Bitmap	image/pict
Macintosh Bitmap	image/x-pict
Portable Network Graphics	image/png
PPM Image	image/x-portable-pixmap
PPM Image	image/x-p
PPM Image	image/x-ppm
PPM Image	application/ppm

**TABLE B-1. File Type Mapping Table for MIME Content-Files (Continued)**

<b>FILE TYPE</b>	<b>MIME CONTENT-TYPE</b>
PPM Image	application/x-ppm
Postscript	application/postscript
Adobe Photoshop (PSD)	application/octet-stream
Paint Shop Pro	image/bmp
Quick Time Media	video/quicktime
Quick Time Media	video/x-quicktime
Quick Time Media	image/mov
Quick Time Media	audio/aiff
Quick Time Media	audio/x-midi
QuarkXPress Document (QXD)	application/quarkxpress
QuarkXPress Document (QXD)	application/x-quark-express
Real Audio	audio/vnd.rn-realaudio
Real Audio	audio/x-pn-realaudio
Real Audio	audio/x-realaudio
Real Audio	audio/x-pm-realaudio-plugin
Real Audio	video/x-pn-realvideo
RAR	application/rar
Sun Raster (RAS)	image/x-cmu-raster
Sun Raster (RAS)	image/cmu-raster
Real Media	application/vnd.rn-realmedia



**TABLE B-1. File Type Mapping Table for MIME Content-Files (Continued)**

<b>FILE TYPE</b>	<b>MIME CONTENT-TYPE</b>
Microsoft RTF	application/rtf
Microsoft RTF	application/x-rtf
Microsoft RTF	text/richtext
Lotus ScreenCam Movie	application/vnd.lotus-screencam
Lotus ScreenCam Movie	application/x-lotusscreencam
Lotus ScreenCam Movie	application/x-screencam
Lotus ScreenCam Movie	video/x-scm
Lotus ScreenCam Movie	video/x-screencam
IRCAM Sound File	audio/x-sf
Sonic Foundry File	audio/sfr
Macromedia Flash	application/x-shockwave-flash
TAR	application/x-tar
TAR	application/tar
TAR	application/x-gtar
TAR	multipart/x-tar
TAR	application/x-compress
TAR	application/x-compressed
Targa Image	image/tga
Targa Image	image/x-tga
Targa Image	image/targa

**TABLE B-1. File Type Mapping Table for MIME Content-Files (Continued)**

<b>FILE TYPE</b>	<b>MIME CONTENT-TYPE</b>
Targa Image	image/x-targa
TIFF	image/tiff
TNEF file	application/ms-tnef
TNEF file	application/vnd.ms-tne
ASCII Text	text/plain
ASCII Text	application/txt
ASCII Text	text/html
ASCII Text	text/css
UUENCODE	text/x-uuencode
VBScript	text/vbscript
VBScript	text/vbs
VBScript	application/x-vbs
Creative Voice Format (VOC)	audio/voc
Creative Voice Format (VOC)	audio/x-voc
Microsoft RIFF	audio/wav
Microsoft RIFF	application/x-cdf
Microsoft RIFF	application/x-cmx
Microsoft RIFF	image/x-cmx
Microsoft RIFF	drawing/cmx
Microsoft RIFF	application/cmx

**TABLE B-1. File Type Mapping Table for MIME Content-Files (Continued)**

<b>FILE TYPE</b>	<b>MIME CONTENT-TYPE</b>
Webshots Picture Collection	application/x-webshots
Webshots Picture Collection	application/wbc
Windows Metafile	application/x-msmetafile
Windows Metafile	application/wmf
Windows Metafile	application/x-wmf
Windows Metafile	image/x-wmf
Windows Metafile	zz-application/zz-winassoc-wmf
PKZIP	application/zip
PKZIP	application/x-zip
PKZIP	application/x-zip-compressed
PKZIP	multipart/x-zip
PKZIP	application/x-compress
PKZIP	application/x-compressed
ACE Compression File	application/x-ace
ACE Compression File	application/x-compressed
Apple Sound	audio/aiff
Apple Sound	audio/x-aiff
Audio InterChange File Format from Apple/SGI	audio/aiff
Audio InterChange File Format from Apple/SGI	audio/x-aiff

**TABLE B-1. File Type Mapping Table for MIME Content-Files (Continued)**

<b>FILE TYPE</b>	<b>MIME CONTENT-TYPE</b>
Audio InterChange File Format from Apple/SGI	sound/aiff
Audio InterChange File Format from Apple/SGI	audio/rmf
Audio InterChange File Format from Apple/SGI	audio/x-rmf
Audio InterChange File Format from Apple/SGI	audio/x-pn-aiff
Audio InterChange File Format from Apple/SGI	audio/x-gsm
Audio InterChange File Format from Apple/SGI	audio/x-midi
Audio InterChange File Format from Apple/SGI	audio/vnd.qcelp
ARJ	application/arj
ARJ	application/x-arj
ARJ	application/x-compress
ARJ	application/x-compressed
ARJ	zz-application/zz-winassoc-arj
Advanced Streaming Format	video/x-ms-asf
Advanced Streaming Format	video/x-ms-asf-plugin
Advanced Streaming Format	video/x-ms-wm
Advanced Streaming Format	video/x-ms-wmx

**TABLE B-1. File Type Mapping Table for MIME Content-Files (Continued)**

<b>FILE TYPE</b>	<b>MIME CONTENT-TYPE</b>
Advanced Streaming Format	audio/asf
Advanced Streaming Format	application/asx
Advanced Streaming Format	application/x-mplayer2



# Appendix C

## Architecture and Configuration Files

Topics in this appendix include the following:

- [Main Components on page C-2](#)
- [Main Services on page C-2](#)
- [Scheduled Tasks on page C-3](#)
- [About Configuration Files on page C-4](#)
- [Protocol Handlers on page C-6](#)
- [Scanning Modules on page C-6](#)

## Main Components

The following are the main InterScan Web Security Virtual Appliance (IWSVA) modules:

- **Main Program:** Installs the Web console and the basic library files necessary for IWSVA.
- **Advanced Threat Protection:** Installs the services necessary for HTTP scanning (either ICAP or HTTP scanning) and URL blocking
- **Application Control:** Provides a security technology that automates the discovery of popular Internet applications and allows administrators to control them using policies.
- **HTTP Inspection:** Allows administrators to identify behavior and filter web traffic according to HTTP methods, URLs, and headers.
- **Data Loss Prevention:** Shows all DLP policies on the system—enabled as well as disabled.
- **FTP Scanning:** Installs the service that enables FTP scanning.
- **URL Filtering:** Installs the service necessary for URL filtering.
- **Applets and ActiveX Scanning:** Installs the service necessary for checking Java applet and ActiveX object digital signatures, and instrumenting applets so their execution can be monitored for prohibited operations.
- **SNMP Notifications:** Installs the service to send SNMP traps to SNMP-compliant network management software.
- **Control Manager Agent for IWSVA:** Installs the files necessary for the Control Manager agent to enable monitoring and configuration through Control Manager.

## Main Services

To start or stop any of the services in this section, you must be logged on to IWSVA as `root` using either a local terminal or SSH. The `root` user can only stop or start the HTTP and FTP services from within IWSVA CLI (see [Enabling the HTTP/HTTPS Traffic Flow on page 6-2](#) and [Enabling FTP Traffic and FTP Scanning on page 11-5](#)). No other services can be stopped or started from within IWSVA.



The following services are used by IWSVA:

- **Trend Micro IWSVA Console (java):** This service is the Web server hosting the Web console.
- **Trend Micro IWSVA for FTP (isftpd):** This service enables the FTP traffic flow and FTP virus scanning.
- **Trend Micro IWSVA for HTTP (iwssd):** This service enables the HTTP traffic flow and HTTP scanning (including FTP over HTTP). It also handles Applets and ActiveX security processing.

---

**Note:** FTP over HTTP is not supported in Transparent Bridge Mode.

---

- **Trend Micro IWSVA Log Import (logtodb):** This service writes logs from text files to the database.
- **Trend Micro IWSVA Notification Delivery Service (isdelvd):** This service handles administrator notifications (through email) and user notifications (through browser).
- **Trend Micro SNMP Service (svcmonitor if using the Linux SNMP agent, snmpmonitor if using the IWSVA-installed SNMP agent):** This service sends SNMP trap notifications to SNMP-capable network monitoring devices.
- **Trend Micro Control Manager Service (En\_Main):** This service permits IWSVA configuration and status reporting through Trend Micro Control Manager, if you are using Control Manager.
- **Trend Micro IWSVA for Dashboard (ismetricmgmtd):** This service collects system resource data to be used in the display of real-time dashboard metrics.

## Scheduled Tasks

When installing IWSVA, the setup program creates several scheduled tasks.

- **purgefile:** Runs daily at 2:00 am to delete old text log files, subject to the configured time interval to retain logs.
- **schedulereport:** Runs hourly to check if a scheduled report is configured to run.
- **schedulepr\_update:** Runs daily to check if it is time to update the product registration/license.

- **schedule\_au:** Runs every 15 minutes to check if it is time to update the pattern file or other program components.
- **cleanfile:** Runs hourly, to remove temporary files downloaded for scan-behind or large file scanning.
- **DbOldDataCleanup.sh:** Runs daily at 2:05 am to clean up old reporting log data in the database and cleans up the old access quota counters in the database.
- **svc\_snmpmonitor.sh:** Runs every five minutes to verify that the logtodb, mail, postgres and metric daemons are running. It restarts them if they are not.
- **db\_reindex.sh:** Runs daily at 28 minutes past every other hour to rebuild corrupted database indices containing any invalid data. This maintains optimum database performance.
- **db\_vacuum.sh:** Runs daily at 3:58 am to perform garbage collection to free up unused space from database tables in order to maintain optimum database performance.

## About Configuration Files

To access configuration files, you must be logged on to the appliance as `root` using either a local terminal or SSH.

There are three types of configuration files: main, protocol module, and scanning module. All the configuration files are in the `{IWSS root}` directory; the default location for `{IWSS root}` is `/etc/iscan/`. The main configuration file is in `intscan.ini`.

- Settings specific to virus scanning are in:  
`{IWSS root}/IWSSPIScanVsapi.dsc`
- Settings that are specific to the ICAP protocol are in:  
`{IWSS root}/IWSSPIProtocolIcap.pni`
- Settings that are specific to the stand-alone proxy are in:  
`{IWSS root}/IWSSPIProtocolHttpProxy.pni`
- Settings for URL filtering scanning module are in:  
`{IWSS root}/IWSSPIUrlFilter.dsc`

- Settings specific to reporting are in:  
`{IWSS root}/report.ini`
- Settings specific to botnet scanning are in:  
`{IWSS root}/IWSSPINcieScan.dsc`
- Settings for DLP scanning are in:  
`{IWSS root}/IWSSPIDlpFilter.dsc`
- Settings specific to java/activeX scanning are in  
`{IWSS root}/IWSSPIJavascan.dsc`
- Settings specific http inspection are in:  
`{IWSS root}/IWSSPISigScan.dsc`
- Settings specific ftp scanning are in:  
`{IWSS root}/IWSSPIProtocolFtp.pni`
- Settings specific application control are in:  
`{IWSS root}/appcMapping.ini`
- Settings for the URL Categorization database are in:  
`{IWSS root}/urlfxIFX.ini`
- Settings for default URL categories and their mapping information are in:  
`{IWSS root}/urlfcMapping.ini`
- Settings for the list of IP address and IP ranges of all machines allowed to access the IWSVA device are in:  
`{IWSS root}/ClientACL_http.ini (for HTTP)`  
`{IWSS root}/ClientACL_ftp.ini (for FTP)`
- Settings for rules that define what ports IWSVA forwards HTTP requests to are in:  
`{IWSS root}/HttpPortPermission_http.ini (for HTTP)`  
`{IWSS root}/HttpPortPermission_ftp.ini (for FTP)`
- Settings for rules that define what ports IWSVA allows HTTPS tunneling to are in:

{IWS root}/HttpsConectACL\_http.ini

- Settings for list of IP address and IP ranges of trusted servers are in:

{IWS root}/ServerIPWhiteList\_http.ini (for HTTP)

{IWS root}/ServerIPWhiteList\_ftp.ini (for FTP)

The IWSVA Web console varies depending on which modules are used. If you have been using a previous version of IWSVA, there are also many new features available in IWSVA that require new .ini file entries.

## Protocol Handlers

Functions responsible for interpreting and processing messages in some recognized transmission protocols are encapsulated in a dynamic library referred to as a protocol handler. IWSVA provides a choice of either an ICAP protocol handler, which enables IWSVA to act as an ICAP server, or an HTTP proxy handler, wherein IWSVA acts like a direct HTTP proxy server. (The HTTP protocol handler is also used in bridge mode.) The application binary is independent of the protocol handler, allowing the same application to support different protocols with a configuration change.

Provide the complete path of the active configuration file of the protocol in the `main/protocol_config_path` entry in the `intscan.ini` file application.

Protocol handlers require their own specific configuration files, which contain entries that pertain only to that protocol. These protocol configuration files are denoted with a `.pni` filename extension.

## Scanning Modules

Traffic scanning functionality is provided through dynamic libraries known as scanning modules. The first scanning module available to IWSVA provides content scanning using the scan engine.

Each scanning module has a configuration file with a `.dsc` extension. The IWSVA application locates the available scanning modules by searching for `.dsc` files in the directory that is provided in the `scan/plugin_dir` entry in the `intscan.ini` file.

# Appendix D

## OpenLDAP Reference

Though OpenLDAP supports Kerberos authentication, the packages to enable Kerberos authentication support are not installed by default. This appendix covers how to install and configure Kerberos support for OpenLDAP. In addition, this appendix explains how to set up your OpenLDAP directory so InterScan Web Security Virtual Appliance (IWSVA) can query it when using the user/group authentication method.

This chapter includes the following topics:

- [OpenLDAP Server Side Configuration on page D-2](#)

## OpenLDAP Server Side Configuration

### Software Package Dependencies

The following software packages are compatible with IWSVA:

- cyrus-sasl-2.1.19
- db-4.2.52.NC
- heimdal-0.6.2
- openldap-2.3.39
- openssl-0.9.7d

### Configuration Files

Using OpenLDAP with IWSVA requires modifying the following configuration files:

```
/etc/openldap/ldap.conf
/etc/openldap/slapd.conf
```

### Sample ldap.conf

```

System-wide ldap configuration files. See ldap.conf(5) for
details
This file should be world readable but not world writable.

OpenLDAP supports the ldap.conf file. You could use this file to
specify a number of defaults for OpenLDAP clients. Normally this
file can be found under /etc/openldap based on /etc/init.d/ldap
start script's setting

Set host IP address or fully qualified domain name
HOST example.peter.com
#HOST 10.2.1.1

Set the default BASE DN where LDAP search will start off
BASE dc=peter,dc=com

Set the default URI
```

```
URI ldap://example.peter.com

SASL options
specify the sasl mechanism to use. This is a user-only option.
SASL_MECH <mechanism>
specify the realm. This is a user-only option
SASL_REALM <realm>
specify the authentication identity.
SASL_AUTHCID <authcid>
```

## Sample slapd.conf

```
#
See slapd.conf(5) for details on configuration options.
This file should NOT be world readable.
#
Enforce all changes to follow the defined schemas loaded via
include statements in the conf file

NOTE 1
All the OpenLDAP config files and backend databases are accessed
and created by "ldap", so if you touch these config files by
"root", "a Permission Denied" error will occur. Please modify
ownership accordingly.

NOTE 2
krb5-kdc.schema fails to work with current OpenLDAP 2.2.x distro
krb5ValidStart, krb5ValidEnd, krb5PasswordEnd need to have
"EQUALITY generalizedTimeMatch" inserted before the ORDERING
statement.
www.openldap.org/lists/openldap-bugs/200309/msg00029.html

Enforce all changes to follow the defined schemas loaded via
include statements in the conf file

schemacheck on

Included schemas

include /usr/local/etc/openldap/schema/core.schema
include /usr/local/etc/openldap/schema/krb5-kdc.schema
include /usr/local/etc/openldap/schema/cosine.schema
include /usr/local/etc/openldap/schema/inetorgperson.schema
include /usr/local/etc/openldap/schema/nis.schema
include /usr/local/etc/openldap/schema/java.schema
```

```
Directives say where to write out slapd's PID and arguments
started with

pidfile /usr/local/var/run/slapd.pid
argsfile /usr/local/var/run/slapd.args

Load dynamic backend modules:
modulepath/usr/local/libexec/openldap
moduleloadback_bdb.la
moduleloadback_ldap.la
moduleloadback_ldbm.la
moduleloadback_passwd.la
moduleloadback_shell.la

Sample security restrictions
#Require integrity protection (prevent hijacking)
#Require 112-bit (3DES or better) encryption for updates
#Require 63-bit encryption for simple bind
security ssf=1 update_ssf=112 simple_bind=64

Sample access control policy:
#Root DSE: allow anyone to read it
#Subschema (sub)entry DSE: allow anyone to read it
#Other DSEs:
#Allow self write access
#Allow authenticated users read access
#Allow anonymous users to authenticate
#Directives needed to implement policy:
access to dn.base="" by * read
access to dn.base="cn=Subschema" by * read
access to *
#by self write
#by users read
#by anonymous auth
#
if no access controls are present, the default policy
allows anyone and everyone to read anything but restricts
updates to rootdn. (e.g., "access to * by * read")
#
rootdn can always read and write EVERYTHING!
access to dn.base="" by * read
access to dn.base="cn=Subschema" by * read
access to *
by self write
by users read
```



```
by anonymous auth
by * none

We have found this gives a useful amount of information about
directory

loglevel 256

#Specify the number of threads used in slapd, default = 16
#Increasing or decreasing the number of threads used can
#drastically affect performance, we found 20 threads to be optimal
#for our setup, but it can be different under other operating
#systems

threads 20

#Tell slapd to close connections that have been idle for 30 seconds
#or more

idletimeout 30

Enable LDAPv2 support. This option is disabled by default.

allow bind_v2

Disable anonymous bind

disallow bind_anon

Comment this section to enable simple bind

#disallow bind_simple

NOTE 3
SASL Configuration
Caution: make sure you use the canonical name of the machine
in sasl-host. Otherwise, OpenLDAP wont be able to offer GSSAPI
authentication

Set the SASL realm and canonical name of the host
sasl_hostexample.peter.com
sasl_realmPETER.COM

Allow proxy authentication if it's configured

sasl-authz-policyboth

NOTE 4
Mapping of SASL authentication identities to LDAP entries
The sasl-regex line are particularly critical. They are what
rewrite incoming connections who have SASL formatted DNS to the
DNS that are in the directory DB. It's important to remember that
```

```
they are processed in order, so you want to write them from most
specific to most general

NOTE 5
We set the cn=.* since we are going to adopt different security
mechanisms. If Kerberos v5 is the only one used, change wildcard
to cn=GSSAPI,cn=auth

#sasl-regexp uid=(.*/),cn=GSSAPI,cn=auth
#uid=$1,ou=people,dc=peter,dc=com

sasl-regexp uid=(.*/),cn=.*,cn=auth uid=$1,ou=people,dc=peter,dc=com

ldbm database definitions

NOTE 6
Correctly configuring the backend Berkeley DB is very critical
follow the guideline at
http://www.openldap.org/faq/data/cache/1073.html

Cleartext passwords, especially for the rootdn, should
be avoided. See slapasswd(8) and slapd.conf(5) for details.
Use of strong authentication encouraged.

databasebdb

These options specify a DN and passwd that can be used to
authenticate as the super-user entry of the database. The DN and
password specified here will always work, regardless of whether
the entry named actually exists or has the password given.
This solves the chicken-and-egg problem of how to authenticate and
add entries before any entries yet exist

suffix"dc=peter,dc=com"
rootdn"cn=admin,dc=peter,dc=com"
rootpwadmin

NOTE 7
The database directory MUST exist prior to running slapd AND
should only be accessible by the slapd/tools. Mode 700
recommended.

directory/usr/local/var/openldap-data

#Tell the slapd to store the 10000 most accessed entries in memory
#Having a properly configured cache size can drastically affect
#performance

cachesize 10000
```

```

Indices to maintain
Some versions of OpenLDAP don't support the index of uniqueMember
"pres" indexing allows you to see a filter that asks if the
attribute is present in an entry
"eq" indexing allows to ask if an attribute has an exact value
"approx" indexing allows to ask if an attribute value sounds like
something
This option is tied to --enable-phonetic compile option in
OpenLDAP
"sub" indexing allows to do substring search on an attribute's
values

index default eq,pres
index objectclass eq,pres
index cn,sn,givenname,mail eq,pres,approx,sub
index uideq,pres
index uidNumber,gidNumber,memberUid eq,pres

```

## Tools

### To create the server database and associate indices by importing an existing LDIF file:

NAME

slapadd - Add entries to a SLAPD database

SYNOPSIS

```

/usr/sbin/slapadd [-v] [-c] [-d level] [-b suffix] [-n dbnum]
[-f slapd.conf] [-l ldif-file]

```

DESCRIPTION

Slapadd is used to add entries specified in LDAP Directory Interchange Format (LDIF) to a slapd database.

- Dump the server database to an LDIF file. This can be useful when you want to make human-readable backup of current database.

NAME

slapcat - SLAPD database to LDIF utility

SYNOPSIS

```
/usr/sbin/slapcat [-v] [-c] [-d level] [-b suffix] [-n dbname]
[-f slapd.conf] [-l ldif-file]
```

#### DESCRIPTION

slapcat is used to generate an LDAP Directory Interchange Format (LDIF) output based upon the contents of a slapd database.

- Rebuilds all indices based upon the current database contents

#### NAME

slapindex - SLAPD index to LDIF utility

#### SYNOPSIS

```
/usr/sbin/slapindex [-f slapd.conf] [-d level] [-b suffix] [-n
dbname]
```

#### DESCRIPTION

Slapindex is used to regenerate slapd indices based upon the current contents of a database.

- Check the settings of slapd.conf

#### NAME

Slaptest – Check the suitability of the slapd conf file

#### SYNOPSIS

```
/usr/sbin/slaptest [-v] [-d level] [-f slapd.conf]
```

#### DESCRIPTION

Slaptest is used to check the conformance of the slapd.conf configuration file. It opens the slapd.conf configuration file, and parses it according to the general and the backend-specific rules, checking its conformance.

- LDAP query utility

#### NAME

ldapsearch - LDAP search tool

#### SYNOPSIS

```
ldapsearch [-D binddn] [-W] [-w bindpasswd] [-H ldapuri] [-h
ldaphost] [-p ldap- port] [-b searchbase] [-s base|one|sub] [-x]
[-Y mech] [-Z[Z]] filter [attrs...]
```

#### DESCRIPTION

ldapsearch opens a connection to an LDAP server, binds, and performs a search using specified parameters.

#### EXAMPLE

The command performs a query using simple plain text authentication for a matched entry with “uid=peter” and requests the mail attribute for a matched entry to be returned by the LDAP server.

```
ldapsearch -x -D "cn=admin,dc=peter,dc=com" -w admin -b
"dc=peter,dc=com" -s sub "uid=peter" mail
```

For further information, consult the manual page.

#### Verify SASL/OpenLDAP/Kerberos v5 Authentication

```
1. KRB5_CONFIG="/etc/heimdal/krb5.conf" ./ldapsearch -v -x \
-D "cn=admin,dc=peter,dc=com" -W -b "" -s base -LLL \
-H ldap://example.peter.com/ supportedSASLMechanisms
2. KRB5_CONFIG="/etc/heimdal/krb5.conf" ./ldapsearch -b
"dc=peter,dc=com" \
-H ldap://example.peter.com/
3. KRB5_CONFIG="/etc/heimdal/krb5.conf" ./ldapwhoami -H
ldap://example.peter.com
```



# Appendix E

## Best Practices for IWSVA

This appendix contains information about the best practices to follow for InterScan Web Security Virtual Appliance.

The topics include:

- [Authenticating Multiple Users on Shared Personal Computers on page E-2](#)
- [Scanning Considerations on page E-2](#)
- [Keep in mind that entries placed in the Global Trusted URLs white list are not scanned. If you want to scan white listed items, create an Approved List object and use this in the policy's Exception tab. The Exception Tab gives you the option of scanning white listed items in the HTTP and FTP Scan Policies. on page E-6](#)

## Authenticating Multiple Users on Shared Personal Computers

Supporting multiple users on a single shared personal computer (PC) using Microsoft Active Directory server for authentication can present some challenges to IT managers and users alike. IWSVA provides authentication based on a browser challenge and can support the authentication of multiple users on a shared PC using Microsoft Internet Explorer as the default browser.

### Best Practice Suggestions

#### Leveraging Microsoft ShellRunas Utility

- For shared PCs, you can leverage the Microsoft ShellRunas utility to force the user to authenticate each time when Microsoft Internet Explorer is started. The AD credentials are used to authenticate the user and Internet Explorer will leverage the credentials to automatically populate the user ID information in the HTTP header to allow IWSVA to identify the user for logging, reporting, and policy enforcement purposes.
- Download the MS ShellRunas utility from:  
<http://technet.microsoft.com/en-us/sysinternals/cc300361.aspx>
- Users must remember to shut down their IE browser sessions when they're finished using the computer. This allows Microsoft Internet Explorer to prompt the next user for their credentials. User education is critical to the success of this tool.
- Optionally, you can also modify the IP User Cache parameter to extend or shorten the cache interval for the authenticated user cache to further fine tune when users should be prompted for their authentication credentials. The default IWSVA user cache value is 1.5 hours (90 minutes). See the “`configure module ldap ipuser_cache interval <interval>`” CLI command for more information.

### Scanning Considerations

IWSVA's malware scanning architecture is a hybrid solution that uses cloud-based malware detection methods such as Trend Micro's Smart Protection Network (SPN) and local, on-box scan technologies and signature files.



## Smart Protection Network - Cloud Based Services

IWSVA's Smart Protection Network (SPN) is the industry's highest performing cloud-based malware protection service. Smart Protection Network has the following malware detection components:

- **Web Reputation Services (WRS)** is comprised of several correlated services that provide proactive detection and blocking against known bad web sites, domains, files and objects, as well as email related items - including anti-pharming and anti-phishing detection.
  - Domain reputation
  - Page reputation
  - Email reputation
  - File reputation
- **URL Filtering Service** stores its URL database in the cloud for rapid updates and protects Trend Micro's global user base without the need to download and update URL database files on the IWSVA server. This provides up-to-date URL information to every customer and accelerates the proactive protection capabilities to reduce the time between the discovery of a bad site and the time it is added to the URL database to protect all customers.
- **Feedback Loop** provides real-time information from all of Trend Micro's products to update the SPN cloud-based components and URL filtering databases. Malware detected on customer premise equipment are fed back into the cloud architecture and used to fine-tune information in real time. This provides fast proactive protection with low false positives to Trend Micro's global customer base.

## Best Practice Suggestions

Smart Protection Network (SPN) uses cloud-based services and relies on DNS queries for lookups. In order to ensure fast response and minimum latency, the IWSVA device must be configured with a primary and a secondary DNS server.

The DNS servers must be able to support the volume of DNS requests made by IWSVA. In general, before IWSVA builds up its local DNS cache, two DNS requests will be made for each URL accessed. Make sure your DNS server is installed on a server with enough resources and performance to handle the extra DNS volume.

Your DNS server should have a fast network card and be installed on a fast network switch to reduce latency.

Trend Micro recommends on-site DNS servers versus ISP provided DNS servers that are housed outside of the company's network. In general, ISP DNS servers have higher latency and do not support large numbers of DNS queries from a single IP address. Many ISP DNS servers have throttling mechanisms that limit the number of DNS requests per second and can affect IWSVA's Web Reputation Services (WRS) performance.

Try to place your DNS server as close to the IWSVA unit(s) as possible to eliminate unnecessary network hops between the devices to improve network response time and performance.

WRS and URL Filtering requests are made over HTTP port 80. Do not block the IWSVA management IP address for these ports on your firewall.

## Local IWSVA Scan Engines

IWSVA provides local on-box scanning to ensure that content downloaded from the Internet is scanned for malware. Smart Protection Network's Web Reputation Service and URL Filtering services can filter a large percentage of the well-known and newly discovered malware sites and content, but local file scanning ensures that files and objects received are free of embedded viruses, worms, and other malicious code such as Trojans.

IWSVA provides the following local scan engines:

- **WRS Page Analysis** provides real-time content scanning with automatic update service to the Smart Protection Network to ensure that no zero-day threats are found on web sites with good reputation ratings. Any malware found triggers an automated update to the Smart Protection Network to re-examine the source of the content and to update its reputation score.
- **File Type Block** provides the ability to identify and block over 60 different file MIME types. These can include popular files such as Java applets, executable files, Microsoft Office documents, and so forth. See [Mapping File Types to MIME Content-types on page B-1](#) for a detailed list of the supported file type.
- **Virus Scan (VSAPI)** provides signature based virus and malware scanning.

- **IntelliScan** provides the ability to identify and scan files based on their true file type, preventing users from trying to bypass the scan engines by changing the file extension or by some other form of file manipulation.
- **IntelliTrap** provides heuristics scanning to identify and protect against malware that changes or morphs from one state to another as it navigates through the network.
- **Compressed File Scanning** provides protection against malware that is hidden in highly-compressed files that are compressed many times over. Malware authors use this common delivery method to try and evade traditional anti-virus scanning software.
- **Spyware/Grayware Scanning** protects against spyware, dialers, hacking tools, password cracking applications, adware, joke programs, remote access tools, and other grayware types. This local scan engine provides protection based on spyware signatures and is used to compliment the Spyware URL category found in the URL Filtering feature. The local Spyware/Grayware scan engine is used to scan against files download or uploaded to the Internet that may be infected with spyware or grayware. Whereas the URL Filtering Spyware category is used to proactively block access to sites known to contain spyware related files and objects.
- **Applets and ActiveX Scanning** provides protection from malware embedded in Java applets and mobile code such as ActiveX applications found on many modern web sites.
- **Large File Scanning** provides administrators with a way to bypass scanning for large files that can consume a lot of system resources. Traditionally, malware authors do not embed viruses in large files because they want the malware to spread quickly without drawing a lot of attention to the file.

### Best Practice Suggestions

- IWSVA's local scan services operate in a specific order to reduce the need to scan unnecessarily. IWSVA's scanning order for Internet traffic flows in the following order starting with the proactive Smart Protection Network's cloud-based services first.
  - Web Reputation Service (WRS)
  - URL Filtering Service
  - File Type Block
  - Virus Scan

- IntelliTrap Heuristics
- MacroTrap
- IntelliScan True File Type
- Applets and ActiveX
- The Virus Scan (VSAPI) scan engine consumes the most resources. Enabling Web Reputation (WRS) and subscribing to the URL Filtering service and enabling its Computer/Harmful category can greatly reduce the need to perform traditional VSAPI-based virus scans. Making these changes can reduce server resources and provide additional scalability for your environment.
- For trusted, white-listed sites and files that have a high integrity rating, you can disable malware scanning to improve performance and reduce server resource use. Use the Global Trusted URLs, Approved URL and Approved File white lists in the Exception tabs to bypass scanning for trusted sites and files.
- You can configure large file scanning to skip scanning for files over a specific size. This can help reduce unnecessary scanning for larger files and lower resource use to improve capacity and performance.
- To improve user response time for larger file downloads, enable the Large File Handling's Deferred Scanning feature to “trickle” parts of the scanned file to the requesting host. This keeps the browser's file transfer status indicator alive and shows progress to the user while the file is scanned. If malware is found within the trickled file, IWSVA blocks the remainder of the file - resulting in an incomplete file that cannot be executed. For multi-media files or streaming content that uses HTTP port 80, such as YouTube content, you must enable Deferred Scanning to allow portions of the media to flow through. Selecting the “Scan Before Delivery” option blocks the streaming content until it is fully scanned and results in bad user experiences.
- For customers that need to scan the entire file before delivering it to their users, select the “Scan Before Delivery” option from the Large File Handling feature. This instructs IWSVA to buffer the file and completely scan it before delivering any portion to the user. This method is slightly slower in terms of end-user performance perception, but ensures that no portion of the infected file is allowed through.
- Keep in mind that entries placed in the Global Trusted URLs white list are not scanned. If you want to scan white listed items, create an Approved List object and use this in the policy's Exception tab. The Exception Tab gives you the option of scanning white listed items in the HTTP and FTP Scan Policies.

# Appendix F

## WCCP Deployment & Troubleshooting

This appendix contains information about deploying and troubleshooting installation of the InterScan Web Security Virtual Appliance (IWSVA) working with Cisco's Web Cache Communication Protocol (WCCP)

The topics include:

- [Introduction to WCCP on page F-2](#)
- [Deploying WCCP on Cisco 2821 Routers on page F-3](#)
- [Deploying WCCP on Cisco 3750 Switches on page F-6](#)
- [Deploying WCCP on Cisco ASA Devices on page F-9](#)
- [Configuring IWSVA with WCCP Deployment Mode on page F-11](#)
- [Additional IWSVA Tips on page F-15](#)
- [Advanced Concepts: Deploying WCCP for Redundancy and Fault Tolerance on page F-20](#)
- [Troubleshooting Cisco WCCP & IWSVA on page F-23](#)

## Introduction to WCCP

Cisco routers and switches supporting Web Cache Communication Protocol (WCCP) can redirect traffic to one or more transparent proxy web cache servers. Web caches reduce network latency by enabling end users to retrieve web pages that they have accessed previously from a memory buffer or “cache” instead of from a web server.

Cisco created WCCP to control the interaction of external web cache devices with Adaptive Security Appliances. WCCP not only reduces the load on web cache devices, but it also provides load balancing and support for multiple routers and protocols. WCCP is transparent to the end user and requires no modification to the endpoint devices.

## IWSVA and WCCP Overview

This appendix describes how to configure IWSVA to run in WCCP mode and communicate with a Cisco WCCP enabled device in an N-tier environment. When an IWSVA is running in WCCP mode and integrates with a Cisco WCCP device, it becomes a “web cache” even though it does not specifically serve cached content. Instead it serves as a “cache engine” for the ASA and performs web gateway functions for filtering and scanning web content.

Examples used throughout this document illustrate the configuration steps required on the IWSVA and the Cisco WCCP supported devices. Although Trend Micro cannot test and validate every Cisco device that supports WCCP, testing is performed on every IWSVA version with WCCP.

---

**Note:** IWSVA's WCCP implementation defaults to WCCP service 80 and the Dynamic WCCP service type and this is compatible for most WCCP v2 implementations. However, if your Cisco device is using a different WCCP service number other than 80 or is using the Standard WCCP service method, you will need to change the IWSVA's WCCP parameters to match. Please refer to the [Additional IWSVA Tips on page F-15](#) for more information on how to change IWSVA's WCCP service parameters.

---

Examples used in this document were created with IWSVA and the following Cisco products:

- Cisco 2821 router running IOS version 12.4(13r)T
- Cisco 3750 switch running IOS version 12.2(40)SE
- Cisco ASA 5510 running version 8.4(35)k8

## Deploying WCCP on Cisco 2821 Routers

Known issues and deployment requirements for Cisco routers include:

1. Cisco IOS versions 12.2(23) through 12.3(9) have been known to have WCCP connectivity issues. These versions should be avoided with IWSVA integration.
2. The router ID that is automatically selected is the highest IP address configured on the Cisco router. If the interface supporting this IP address is not directly accessible by the IWSVA device, the WCCP L2 redirection method will not function. In this case, you will need to ensure that proper route entries are configured and enabled on your routers and switches to allow IWSVA to communicate with the interface configured with the Router ID.

### Deployment Example

This example uses a Cisco 2821 router running IOS 12.4(13r)T with two network segments - a private network and a public facing DMZ network.

- **Private Network**—192.168.1.0/24 - Supported on the Cisco's GigabitEthernet 0/0 interface with 192.168.1.1 as the gateway address.
- **DMZ Network**—172.16.1.0/24 - Supported on the Cisco's GigabitEthernet 0/1 interface with 172.16.1.5 as the gateway address.
- **IWSVA Device**—172.16.1.101 - Acts as the WCCP cache device and performs content scanning and filtering.

The private network hosts the company's client computers and the DMZ network houses the public facing servers (web, FTP, etc) and the IWSVA unit. IWSVA can access the Internet through the corporate firewall as illustrated in [Figure F-1](#).

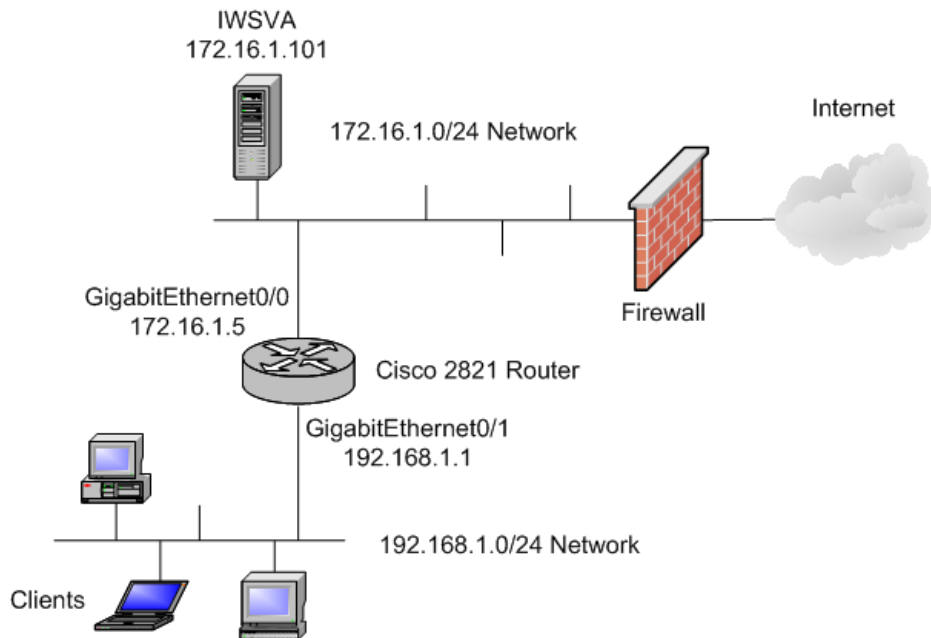

**FIGURE F-1.** Example Topology for Cisco 2821 Router Implementation

## Configuring the Cisco 2821 Router

Log into the Cisco router with administrative permissions and perform the following configuration steps.

### To configure the Cisco 2821 router:

1. Enter the Cisco router's terminal configuration mode.

```
Hostname#conf t
```

```
Hostname (config)#
```



2. Configure a redirect-list containing the client protocol(s) to be redirected to the IWSVA unit. In this example, the HTTP WWW and FTP protocols are redirected for scanning. The access-list number used in this example is 101. But this number can be different for your environment.

```
Hostname (config)# access-list 101 permit tcp 192.168.1.0
0.0.0.255 any eq www
```

```
Hostname (config)# access-list 101 permit tcp 192.168.1.0
0.0.0.255 any eq ftp
```

3. Configure a group-list containing all members of the WCCP server. In this example, we configured a group-list with the IWSVA member. WCCP forwards the protocols selected in the previous step to the IWSVA identified in this group-list. The access-list number used in this example is 22. This number can be different for your environment.

```
Hostname (config)# access-list 22 permit 172.16.1.101
0.0.0.1
```

4. Enable WCCP on the Cisco router. The WCCP service number used in this example is 80. By default, IWSVA always uses service number 80 with the Dynamic WCCP service. If you are using Cisco IOS 12.2 or 12.3, the WCCP version defaults to 2. In these cases, it is not necessary to configure the WCCP version. Please make sure your Cisco device is configured for the same values. The password used in this example is set to "novirus" and it must match the password configured on the IWSVA's WCCP configuration settings.

```
Hostname (config)# ip wccp 80 redirect-list 101 group-list
22 password novirus
```

5. Enable WCCP Outbound redirection on the interface that allows traffic to reach the public Internet. This interface does not need to be the interface where you have installed your cache device - the IWSVA in this example. In this example, the public Internet facing interface is 0/0, and the WCCP redirection is enabled as OUT on this router interface.

```
Hostname (config)# interface GigabitEthernet0/0
```

```
Hostname (config-if)# ip wccp 80 redirect out
```

6. Enable WCCP Inbound redirection on the interface that will be receiving traffic from the client devices. In this example, the client facing interface is 0/1 and we will enable the WCCP redirection as IN on this router interface.

```
Hostname (config)# interface GigabitEthernet0/1
```

```
Hostname (config-if)# ip wccp 80 redirect in
```

Cisco 2821 routers can support GRE and the L2 forwarding methods as well as both Hash and Mask assignment methods. In the above example, the L2 forwarding method was selected along with the Mask assignment method for better performance.

## Deploying WCCP on Cisco 3750 Switches

Known issues and deployment requirements for Cisco switches include:

1. Cisco IOS versions 12.2(23) through 12.3(9) have been known to have WCCP connectivity issues. These versions should be avoided with IWSVA integration.
2. WCCP entries and PBR entries use the same TCAM region. WCCP is supported only on the templates that support PBR: access, routing, and dual IPv4/v6 routing. As a result, for switches (like the 3750, 3560 series) to support WCCP, the SDM template needs to be changed to something other than “default.” When TCAM entries are not available to add WCCP entries, packets are not redirected and are forwarded by using the standard routing tables.
3. The IWSVAs must be directly connected to the switch that has WCCP enabled. They should be in the same subnetwork.
4. Configure the switch interfaces that are connected to the web clients, IWSVAs, and the web server as Layer 3 interfaces (routed ports and switch virtual interfaces [SVIs]). For WCCP packet redirection to work, the servers, IWSVAs, and clients must be on different subnets.
5. Check the supported forward and assignment method by the switch, and make sure these two settings are correct in IWSVA. For example, 3560 and 3750 series just support L2 forwarding method and Mask assignment method.
6. You cannot configure WCCP and VPN routing/forwarding (VRF) on the same switch interface.
7. You cannot configure WCCP and PBR on the same switch interface.

8. You cannot configure WCCP and a private VLAN (PVLAN) on the same switch interface.

## Deployment Example

This example uses a Cisco 3750 switch running IOS 12.2(40)SE with two VLAN network segments - VLAN 30 and VLAN 160.

- **VLAN 30 Network**—10.168.30.0/24 - Supports the clients on the corporate network. This VLAN has 10.168.30.254 as the gateway address.
- **VLAN 160 Network**—10.168.160.0/24 - Supports the IWSVA and other servers and has access to the public Internet through the corporate firewall. This VLAN has 10.168.160.254 as the gateway address
- **IWSVA Device**—10.168.160.54 - Acts as the WCCP cache device and performs content scanning and filtering.

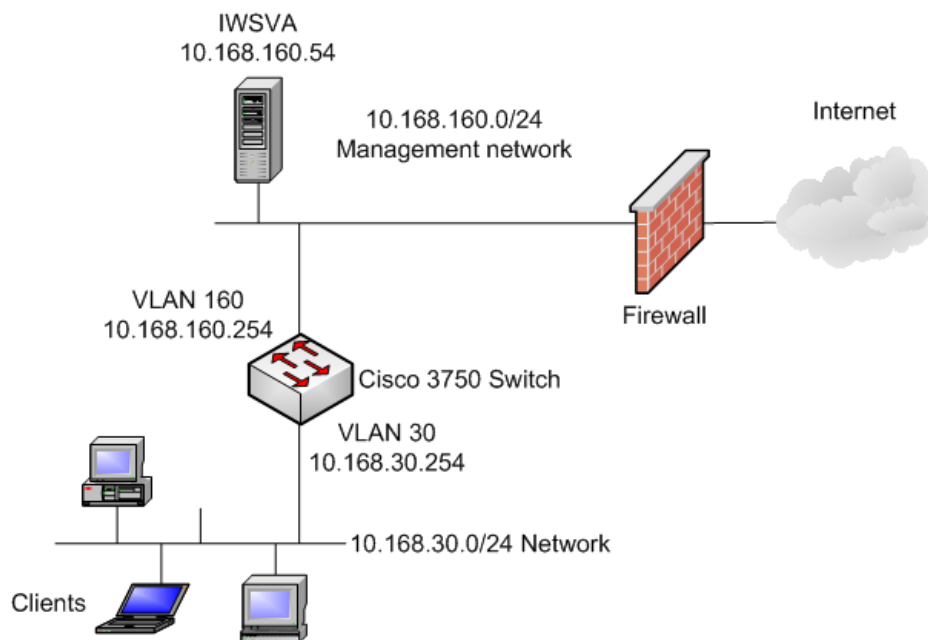

FIGURE F-2. Example Topology for Cisco 3750 Switch Implementation

## Configuring the Cisco 3750 Switch

Log into the Cisco 3750 switch with administrative permissions and perform the following configuration steps.

### To configure the Cisco 3750 switch:

1. Enter the Cisco switch's terminal configuration mode.

```
Switch #conf t
Switch(config)#
```

2. Configure an access-list containing the client VLAN(s) to be redirected to the IWSVA unit. In this example, we will redirect the 10.168.30.0/24 client subnet. The access-list used is the standard list and the WCCP80 is the identifier for this ACL. It can be different in your environment to match your naming conventions.

```
Switch (config)# ip access-list standard wccp80 permit
10.168.30.0 0.0.0.255
```

3. Configure a group-list containing all members for the WCCP cache. In this example, a group-list is configured with the IWSVA device's 10.168.160.54 IP address. The IWSVA device handles the inbound redirection where WCCP will forward the traffic you selected in the previous step. The group80 is the identifier for this ACL and it can be different in your environment to match your naming conventions.

```
Switch (config)# ip access-list standard group80 permit
host 10.168.160.54
```

4. Enable WCCP on the Cisco switch. The WCCP service number used in this example is 80. By default, IWSVA uses service number 80 with the Dynamic service type. Please make sure your Cisco device is configured for the same values. The password used in this example is set to "novirus" and it must match the password configured on the IWSVA's WCCP configuration settings.

```
Switch (config)# ip wccp 80 redirect-list wccp80 group-list
group80 password novirus
```

5. Enable WCCP inbound redirection on the VLAN interface that is connected to the clients. The client side interface must be a different VLAN (subnet) from the IWSVA and the web server VLAN(s) - otherwise, proper WCCP redirection will

fail. In this example, the client side subnet is VLAN30 and the IWSVA server side subnet is VLAN160.

```
Switch (config)# interface vlan 30
Switch (config-if)# ip wccp 80 redirect in
```

6. On the IWSVA device's Web UI for WCCP configuration, make sure that the L2 forwarding method and the Mask assignment method are selected. For Cisco 3750 switches, this is the only supported configuration for these two parameters.

## Deploying WCCP on Cisco ASA Devices

Known issues and deployment requirements for Cisco ASA devices include:

1. The Cisco ASA must be running version 7.2.1 or higher in order to support WCCP. Avoid using version 7.2(2) as this is known to have compatibility issues with IWSVA.
2. The Cisco ASA only supports a topology where the clients and the IWSVA device are on the same internal interface of the ASA device. This allows IWSVA to communicate directly with the client hosts without needing to go through the ASA device.
3. The Router ID that is automatically selected is the highest IP address configured on the Cisco ASA. If the Router ID happens to be on an interface that is external to the IWSVA device, such as on the DMZ interface or the external Internet facing interface, the proper routes must be defined on all necessary routing and switching devices to allow IWSVA access to the Router ID's IP address.

## Deployment Example

This example uses a Cisco ASA 5510 running software version 8.4(35)k8 with two network segments—an internal and external network.

- **Internal Network**—192.168.1.0/24 - Supports the internal network where the clients reside. The internal network also houses the IWSVA device. 192.168.1.1 is the gateway address defined on the ASA's 0/1 interface.

- **External Network**—172.16.12.0/24 - Supports the external network and the path to the public Internet. 172.16.12.1 is the gateway address defined on the ASA's 0/0 interface.
- **IWSVA Device**—192.168.6.10 - Acts as the WCCP Cache device and performs content scanning and filtering.

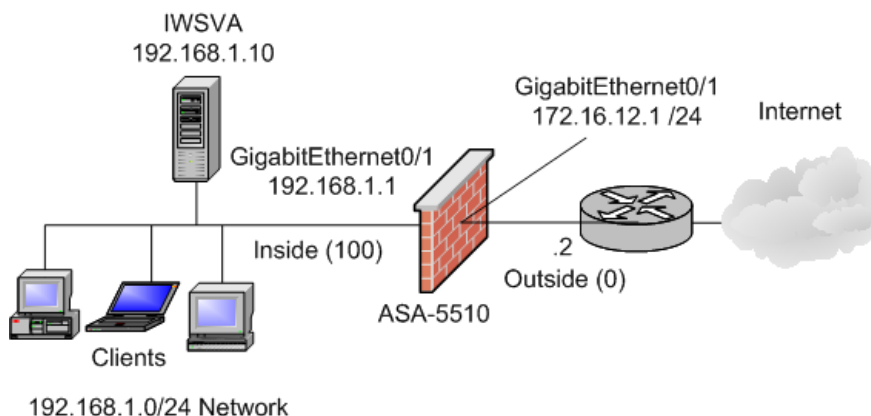

**FIGURE F-3. Example topology for Cisco ASA implementation**

## Configuring the Cisco ASA

Log into the Cisco ASA with administrative permissions and perform the following configuration steps.

### To configure the Cisco ASA:

1. Enter the Cisco ASA's terminal configuration mode.

```
ASA #conf t
ASA(config)#
```
2. Configure an access-list containing the WCCP server member(s). In our example, there is only one WCCP server which is the IWSVA device.

```
ASA (config)# access-list wccp-servers permit ip host
192.168.1.10 any
```

3. Create an access-list to allow the ASA to redirect traffic to the cache server. In our example, the 192.168.1.0/24 subnet will be redirected to the IWSVA acting as the cache server.

```
ASA (config)# access-list wccp-traffic permit ip 192.168.1.0
255.255.255.0 any
```

4. Configure WCCP to redirect traffic from the “wccp-traffic” filter to the “wccp-servers” device. The password used in this example is set to “novirus” and it must match the password configured on the IWSVA's WCCP configuration settings.

```
ASA (config)# wccp web-cache group-list wccp-servers
redirect-list wccp-traffic password novirus
```

5. Enable WCCP inbound redirection on the internal client interface. In this example, the internal client interface is called “inside”. The standard service is “web-cache” (service group id 0), which intercepts TCP port 80 (HTTP) traffic and redirects it to the cache servers.

```
ASA (config)# wccp interface inside web-cache redirect in
```

In this example, the GRE forwarding method and the Hash assignment were selected in the IWSVA device's WCCP configuration Web UI screen.

## Configuring IWSVA with WCCP Deployment Mode

WCCP is supported on specific versions of IWSS and on all versions of IWSVA. The configuration steps are very similar between each IWSVA version and this document will highlight the installation procedure with IWSVA.

The minor differences between IWSS and IWSVA WCCP deployments include the following:

- **Forward Method**—The IWSA 3.1 and IWSVA products support both GRE and L2 forwarding methods. IWSS 3.1 only supports GRE. Generally, the L2 forward method can achieve better performance over GRE, but it depends on the network topology and the Cisco device. For example, Cisco routers supporting WCCP version 1 cannot use the L2 forward method.

- **Router IP Address**—The Router ID of WCCP service group can have an effect on the topology design. The Router ID is treated as an IPv4 address and can also be used as the source address of any WCCP-generated GRE frames. When the GRE forward method is configured, IWSVA will use the Router ID as the source IP address of the GRE packets.

Most Cisco routers do not allow the re-configuration of the Router ID. Cisco routers automate the selection of the Router ID by leveraging the highest reachable IPv4 address defined on the router. However, this IP address may not be the best choice when it comes to the WCCP Router ID and customers must ensure that their networking devices' route tables are updated accordingly to allow communications between the Router ID's IP address and the IWSVA device.

- **Assignment Method**—With WCCP, either the Hash or Mask assignment method can be used. The Mask assignment method is only supported with IOS versions supporting WCCP version 2. The IWSS products only support the Hash assignment method while the IWSVA products can support both the Hash and the Mask assignment methods.

## Configuring WCCP on IWSVA Device

Depending on the version of IWSVA used, the WCCP configuration is done in the Deployment Wizard or in the HTTP configurations under the Proxy Deployment (older versions). The examples in this installation primer will use IWSVA to illustrate the WCCP configuration steps.



Figure 4 shows the WCCP parameters and gives an explanation of each WCCP parameter required for a basic WCCP v2 deployment with the default WCCP service 80 and Dynamic service type.

**TREND MICRO™ Deployment Wizard**

**Web Cache Coordination Protocol (WCCP) Settings**

Please specify the WCCP settings.

**Steps**

1. Deployment Mode
- 2. WCCP Settings**
3. Network Interface
4. Static Routes
5. Product Activation
6. System Time
7. Summary
8. Results

**HTTP Listening Port**

Port:  (Default = 8080)

**WCCP Settings**

Router IP address:   
Use comma "," to separate multiple addresses

Password:  (Uses password security)

Auto-negotiation:  ▾

Forwarding method:  ▾  ▾ Tunneling Encapsulation (GRE) ▾

Assignment method:  ▾

Service group:  ▾  (51-255; default = 80)

Protocols redirected:  HTTP (80)  HTTPS (443)  FTP (21)

**Anonymous FTP over HTTP**

Email address:

< Back   Next >   Cancel

FIGURE F-4. IWSVA's Deployment Wizard WCCP Settings Screen

See [Table F-1](#) for the WCCP settings and descriptions.

**TABLE F-1. WCCP Settings**

PARAMETER	DESCRIPTION
Router IP address	Enter the Cisco device(s) IP addresses for the interfaces that will be redirecting traffic to the IWSVA devices for scanning and URL filtering. Multiple Cisco device IP addresses are entered and separated by commas.
Password	Used if the Cisco routers were configured with a security password for WCCP. Passwords must match between IWSVA and the Cisco device.
Forwarding Method	The WCCP forwarding methods supported are GRE and Layer2 (L2). This setting must match the forwarding type provided by the Cisco device. Generally, L2 forwarding provides slightly better performance, but is not routable and requires the clients and the IWSVA to be on the same subnet/VLAN
Assignment Method	The Mask assignment method used for the WCCP protocol. Hash table and Mask value sets are supported and the assignment method selected should match the Cisco device's abilities. Check your Cisco device's IOS version for more information on the assignment methods supported.
Service Group	The service group can be set for Standard or Dynamic and the default service group ID is 80. Change this value to match your Cisco device's service group settings.
Redirected Protocols	The protocols that are redirected from the Cisco device to the IWSVA for content scanning. Options include HTTP (80), HTTPS (443), and FTP (21).

## Additional IWSVA Tips

Cisco's WCCP is a proprietary redirection technology that is unique to Cisco routers and switches. As such, its implementation can vary slightly between IOS versions running on different devices and this may require further fine tuning on the IWSVA device. This section discusses a few examples where additional fine tuning may be required to fully achieve compatibility.

### IWSVA's WCCP Configuration File

IWSVA stores its WCCP configuration in the `IWSSPIProtocolHttpProxy.pni` file under the `/var/iwss` directory and is used by the WCCP daemon. If you need to change any WCCP parameters that are not exposed on the IWSVA WCCP web UI configuration screen, this is the configuration file you will need to modify. Trend Micro recommends configuring the WCCP function from the IWSVA Web UI under normal circumstances and only manually making changes to the `IWSSPIProtocolHttpProxy.pni` file when absolutely necessary.

Trend Micro highly recommends that you make a copy of the file beforehand. You can use the “cp” copy command to backup the file:

```
cp IWSSPIProtocolHttpProxy.pni IWSSPIProtocolHttpProxy.pni_backup
```

The file can be opened and changed with an editor such as “vi”. If you are new to the vi editor, you can obtain more information on its commands from any of the following web sites:

<http://www.eng.hawaii.edu/Tutor/vi.html>

<http://www.cs.rit.edu/~cslab/vi.html>

<http://www.cs.colostate.edu/helpdocs/vi.html>

Whenever changes are made, the file must be saved and the WCCP daemon must be restarted to activate the new changes. Restart the WCCP server daemon with the following commands:

```
/usr/iwss/S99ISWCCPd stop
```

```
/usr/iwss/S99ISWCCPd start
```

The following WCCP parameters can be manually changed from the IWSSPIProtocolHttpProxy.pni configuration file.

```
Name: wccp_router
Type: address
Default:
Description
Please put one to eight IP Addresses of Cisco routers that you
will register your IWSx to.
Example: wccp_router=192.168.1.254,192.168.2.254
wccp_router=

Name: wccp_address
Type: address
Default:
Description
Use this option if you require WCCP to use a specific interface
address.
The default behavior is to not bind to any specific address.
Example: wccp_address=192.168.1.1
wccp_address=

NAME: wccp_forwarding_method
TYPE: int
DEFAULT: 1
Description:
WCCP2 allows the setting of forwarding methods between the
router/switch and the cache. Valid values are as follows:
1 - GRE encapsulation (forward the packet in a GRE/WCCP tunnel)
2 - L2 redirect (forward the packet using Layer 2/MAC rewriting)
wccp_forwarding_method=1

NAME: wccp_return_method
TYPE: int
DEFAULT: 1
Description:
This field is reserved for the future. Any change to the value
will take
no effect.
wccp_return_method=1
```

```
NAME: wccp_assignment_method
TYPE: int
DEFAULT: 2
Description:
Cisco assignment method, 1 is Hash, 2 is Mask.
wccp_assignment_method=2

#wccp_std_service=standard 0
#wccp_dynamic_service=dynamic 80

NAME: wccp_service
TYPE: wccp_service
DEFAULT:
Description:
Dynamic WCCPv2 services require further information to define the
traffic you wish to have diverted.
The format is:
#
wccp_service <id> protocol=<protocol> flags=<flag>,<flag>..
priority=<priority> ports=<port>,<port>..
#
The relevant WCCPv2 flags:
+ src_ip_hash, dst_ip_hash
+ source_port_hash, dest_port_hash
+ src_ip_alt_hash, dst_ip_alt_hash
+ src_port_alt_hash, dst_port_alt_hash
+ ports_source, ports_defined
#
The port list can be one to eight entries.
wccp_service=dynamic 80 protocol=tcp flags=src_ip_hash priority=120
ports=80,21,443

NAME: wccp_service_info
TYPE: wccp_service_info
DEFAULT:
Description:
Dynamic WCCPv2 services require further information to define the
traffic you wish to have diverted.
The format is:
#
wccp_service_info <id> protocol=<protocol> flags=<flag>,<flag>..
```

```
priority=<priority> ports=<port>,<port>..
#
The relevant WCCPv2 flags:
+ src_ip_hash, dst_ip_hash
+ source_port_hash, dest_port_hash
+ src_ip_alt_hash, dst_ip_alt_hash
+ src_port_alt_hash, dst_port_alt_hash
+ ports_source, ports_defined
#
The port list can be one to eight entries.

wccp_service_info=80 protocol=tcp flags=source_port_hash,
src_port_alt_hash priority=120 ports=80,21,443

NAME: wccp_password
TYPE: cyphered text
DEFAULT:
Description:
MD5 service authentication can be enabled by setting
wccp_password=<cyphered password>.
Please note that the user should not modify this field manually.
When the user set the password on the WebUI, the UI will use the
encrypt the password with MD5 and save it in the configuration
file
wccp_password=

wccp_logging=0
0 - off, no WCCP log, error only
1 - on (default), write WCCP log to http.log file
```

## Changing the Default WCCP Service

By default, IWSVA is setup to use WCCP service 80 and the Dynamic service type. This works well in many WCCP v2 environments, but may require modification if these values are changed on the Cisco device.

**To change from the default WCCP service values:**

1. Log into the IWSVA's console using the “root” level user for full administrative rights.
2. Navigate to the `/etc/iscan` directory with the `cd /etc/iscan` command.
3. Open the `intscan.ini` for editing. For example, you can use the `vi intscan.ini` command.
4. Search for the “wccp\_service” parameter by typing `/wccp_service` and pressing **Enter**. The system should show the WCCP settings similar to the following. Note the default service type and number is “dynamic 80”.

```
wccp_service=dynamic 80 protocol=tcp flags=src_ip_hash priority=120
ports=80,21,443,8080
```

5. Change the `wccp_std=dynamic 80` to the new value supported by your Cisco device. For example, change it from Dynamic 80 to Standard 0 as shown in the example below. You will need to place the vi editor into insert mode with `i` before you can make the change.

```
wccp_std_service=standard 0 protocol=tcp flags=src_ip_hash
priority=120 ports=80
```

6. Exit the insert mode by pressing the **Esc** key. Type `:wq` to write and quit.
7. Restart the WCCP Server Daemon with the following commands:

```
/usr/iwss/S99ISWCCPd stop
/usr/iwss/S99ISWCCPd start
```

---

**Note:** If the Standard 0 service is used, the Cisco device can only redirect the HTTP port 80 traffic to the IWSVA device. If the Dynamic service is used, the Cisco device can redirect other ports in addition to port 80. For example, ports 80, 21, 443, and 8080 can be supported under the Dynamic service.

---

## Advanced Concepts: Deploying WCCP for Redundancy and Fault Tolerance

There are numerous ways IWSVA can be deployed in WCCP mode. In larger environments where scalability and redundancy are desired, multiple IWSVA's can be deployed with multiple Cisco routers for load balancing and fault tolerance with WCCP version 2.

Figure 5 illustrates an example with a redundant architecture that leverages multiple IWSVA devices and multiple WCCP version 2 capable routers.

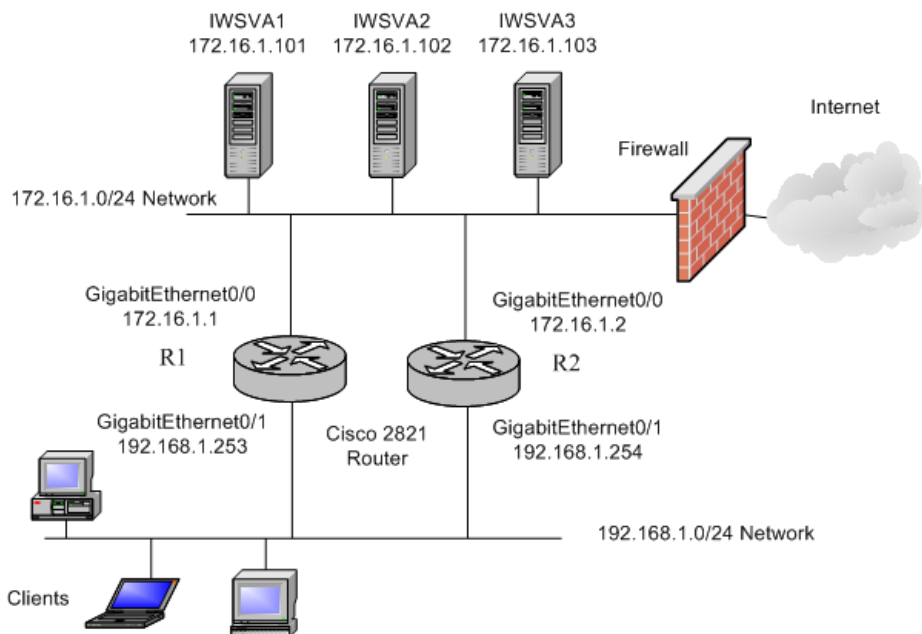

**FIGURE F-5. IWSVA and Cisco Routers Deployed in High Availability Configurations**

In this example, two Cisco 2821 routers running IOS 12.4(13r)T are used to redirect traffic to three IWSVA devices for URL filtering and content scanning. This customer desires load balancing across all three IWSVA devices and fault tolerance in case one of the IWSVA's is brought down. This design allows the remaining IWSVA devices to pick



up the extra load so traffic processing is uninterrupted. If one of the Cisco routers is taken off line, the remaining router will automatically pick up the load and continue the traffic distribution across the IWSVA devices.

## Configuring the Cisco Routers

The configuration steps and commands are similar to the Cisco 2821 router example. The completed router configurations are illustrated below for reference.

### Cisco Router One

The following configuration demonstrates how WCCP is configured and enabled on the first Cisco router. The L2 Forward method and Mask assignment method are used in this example and WCCP version 2 is supported by the router's IOS version.

```
!
ip access-list standard wccp80
permit 192.168.1.0 0.0.0.255
!
ip access-list standard wccp-servers
permit 172.16.1.101
permit 172.16.1.102
permit 172.16.1.103
!
ip wccp 80 redirect-list wccp80 group-list wccp-servers
!
interface GigabitEthernet0/1
ip wccp 80 redirect in
!
```

## Cisco Router Two

The following configuration demonstrates how WCCP is configured and enabled on the second Cisco router. The L2 Forward method and Mask assignment method are used in this example and WCCP version 2 is supported by the router's IOS version.

```
!
ip access-list standard wccp80
permit 192.168.1.0 0.0.0.255
!
ip access-list standard wccp-servers
permit 172.16.1.101
permit 172.16.1.102
permit 172.16.1.103
!
ip wccp 80 redirect-list wccp80 group-list wccp-servers
!
interface GigabitEthernet0/1
ip wccp 80 redirect in
!
```

## Configuring the IWSVA Device

For this example, the three IWSVA devices are configured with the same WCCP settings. [Figure F-6](#) illustrates the configuration values for the WCCP settings.

**TREND MICRO™ Deployment Wizard**

**Web Cache Coordination Protocol (WCCP) Settings**

Please specify the WCCP settings.

**Steps**

1. Deployment Mode
2. WCCP Settings
3. Network Interface
4. Static Routes
5. Product Activation
6. System Time
7. Summary
8. Results

**HTTP Listening Port**

Port: 8080 (Default = 8080)

**WCCP Settings**

Router IP address: 10.168.20.253,10.168.20.254  
Use comma "," to separate multiple addresses

Password:  (Uses password security)

Auto-negotiation: Disable

Forwarding method: Layer 2 (L2)

Assignment method: Mask/value sets

Service group: Dynamic 80 (51-255; default = 80)

Protocols redirected:  HTTP (80)  HTTPS (443)  FTP (21)

**Anonymous FTP over HTTP**

Email address: anonymus@iwss.trendmicro.com

< Back Next > Cancel

**FIGURE F-6.** IWSVA's WCCP Settings Screen

In this example, the two Cisco routers' IP addresses were entered in the Router IP Address(es) field and separated by a comma. The L2 forwarding method and the Mask assignment method were selected.

## Troubleshooting Cisco WCCP & IWSVA

In order to properly troubleshoot your WCCP environment, verbose logging (debug mode) of the WCCP event information may be required on the IWSVA and/or Cisco device. By default, the verbose logging is disabled. If you run into problems that you

cannot solve by using this guide, contact Trend Micro's technical support team for further assistance. They may instruct you to enable verbose/debug logging on the IWSVA and/or Cisco devices to collect the necessary troubleshooting information.

---

**Note:** Running IWSVA and/or the Cisco device in debug or verbose logging modes will add latency as the product may be required to capture large amounts of data for debug purposes. You should only enable these verbose logging modes at the request of the Trend Micro technical support representative.

---

## Enabling IWSVA's WCCP Event Logging

To enable IWSVA's WCCP logging feature:

1. Log into the IWSVA console as the “root” user.
2. Navigate to the `/var/iwss` directory by typing `cd /var/iwss`.
3. Open the `IWSSPIProtocolHttpProxy.pni` file with an editor such as vi. For vi, type `vi IWSSPIProtocolHttpProxy.pni`.
4. Search the file for the “wccp\_logging” parameter by typing `/wccp_logging`.
5. Type `i` to put the vi editor into insert mode and change the value from 0 to 1. This enables the IWSVA's WCCP logging function.

```
wccp_logging=1
0 - off, no WCCP log, error only
1 - on (default), write WCCP log to http.log file
```

6. Exit the insert mode with the **Esc** key and type `:wq` to write the file and quit the vi editor.

The WCCP events will be saved in the HTTP log files under the `/etc/iscan/log` directory on the IWSVA device. The log files will be saved under a format that lists the date and time of the file's creation, such as:

```
http.log.20110325.0001
```

You can navigate to this directory and use an editor such as vi to open and view the file.

## Enabling Cisco Device's WCCP Event Logging

Depending on the Cisco device you are using, how you enable the WCCP event log may be different than what is shown in this installation primer. For our example, a Cisco ASA router was used. Please refer to your Cisco router or switch's administration guide.

### To enable the WCCP event logging on a Cisco device:

1. Log into the Cisco device's console using an administrative account that has configuration rights.
2. Enter the config mode and type the command to enable the WCCP event debug function.

```
Router (config) # debug wccp event
```

## Starting the Troubleshooting Process

If the WCCP enabled devices are not forwarding traffic to the IWSVA devices for scanning, the first thing to check is the communications between the Cisco and IWSVA devices. This section describes the various commands used in troubleshooting the communications between the Cisco device and the IWSVA acting as the cache device.

Several helpful commands provided by the Cisco device that can help verify the configuration and setup of your Cisco device includes the following.

- `show ip wccp <service id>`
- `show ip wccp <service id> view`
- `debug ip wccp event`
- `debug ip wccp packet`

---

**Note:** The commands listed in this troubleshooting section may vary slightly between Cisco device types. The commands illustrated in this section are suited to the Cisco routing and switching devices used throughout this guide. For Cisco ASA devices, the commands vary slightly. Please refer to your Cisco administration guide for more details on these troubleshooting commands.

---

## Checking the IWSVA Configuration

On the IWSVA device, check the following configuration parameters to ensure that communications is being performed properly on the IWSVA device.

### To check the IWSVA configuration:

1. Verify that the password set for the IWSVA WCCP password parameter matches the password on the WCCP device. If the passwords are not the same, no communications between the devices can occur.
2. If the passwords match, make sure the IWSVA Scan Daemons (services) are functioning properly.
  - a. On the IWSVA console, log in as the “root” user.
  - b. Use the `lssof -iTCP -n -P` command to list the daemons and look for the `iwssd` and `isftpd` daemons to make sure they are in “LISTEN” mode

```
-bash-3.2# lssof -iTCP -n -P
COMMAND PID USER FD TYPE DEVICE SIZE NODE NAME
sshd 3823 root 3u IPv4 8554 TCP *:22 (LISTEN)
postmaste 4079 iscan 3u IPv4 10299 TCP *:5432 (LISTEN)
java 4503 iscan 10u IPv4 11379 TCP *:1812 (LISTEN)
java 4503 iscan 24u IPv4 11426 TCP 127.0.0.1:8005 (LISTEN)
microdasy 22870 mds 6u IPv4 389050 TCP *:8070 (LISTEN)
microdasy 22871 mds 4u IPv4 388582 TCP *:8071 (LISTEN)
microdasy 22872 mds 6u IPv4 389053 TCP *:8090 (LISTEN)
iwssd 22901 iscan 9u IPv4 387267 TCP *:8080 (LISTEN)
iwssd 22901 iscan 10u IPv4 387268 TCP *:443 (LISTEN)
iwssd 22901 iscan 11u IPv4 387269 TCP *:8100 (LISTEN)
iwssd 22901 iscan 12u IPv4 387270 TCP *:9090 (LISTEN)
java 22906 iscan 6u IPv4 387474 TCP 127.0.0.1:5963 (LISTEN)
...
isftpd 23244 iscan 9u IPv4 388281 TCP *:21 (LISTEN)
isftpd 23662 iscan 9u IPv4 388281 TCP *:21 (LISTEN)
...
```

FIGURE F-7. Daemon list showing iwssd and isftpd

3. Check the IWSVA's WCCP control connection to make sure it is running correctly.

- a. On the IWSVA console, login as the “root” user.
- b. Check the status value in the `/etc/iscan/wccp_status` file. If the status is set to `2` and the WCCP Server Daemon is running, the control connection is good. The `cat` command can be used to open and view the file.

```
-bash-3.2# cat /etc/iscan/wccp_status
[wccp]
wccp_router=10.204.170.254:2
-bash-3.2#
```

**FIGURE F-8. Check the WCCP control connection**

4. Check the communications between the IWSVA and Cisco device.
  - a. On the IWSVA unit, enable the debug-level logging for the WCCP Server Daemon:
    - i. Set `wccp_logging=1` in `IWSSPIProtocolHttpProxy.pni` file in the `/var/iwss` directory.
    - ii. Restart the WCCP Server Daemon with the following commands:
 

```
/usr/iwss/S99ISWCCPd stop
/usr/iwss/S99ISWCCPd start
```
  - b. Check the `http.log.current_date_time.nnnn` file in the IWSVA's `/etc/iscan/log` directory for the following log entries. You can use an editor such as "vi" to open and view the log file or use the “cat filename |more” command.

```
... <6887> WCCP: Sending WCCPv2 HERE_I_AM for service ID 80
... <6887> WCCP: Received WCCPv2 I_SEE_YOU from 10.13.9.185
... <6887> WCCP: Good Received WCCPv2 I_SEE_YOU
```

If you cannot see the first log entry with the “Here I Am” message, the WCCP transparency mode is not configured or the WCCP Server Daemon is not running.

If you cannot see the second log entry with the “I See You” message, the network device is not responding. Check its configuration or connectivity between IWSVA and the network device.

If you cannot see the third log entry confirming the “I See You”, the message from the network device cannot be parsed. This may happen if you use an unsupported network device.

5. Check the control connection on the Cisco router or switch. Log into the Cisco device's console as the administrative user and perform the following diagnostic procedures:

- a. Run the `show ip wccp <service_id> view` command to obtain a list of all routers and IWSVA systems.

```
Router# show ip wccp 80 view
```

WCCP Routers Informed of:

10.13.10.17

WCCP Cache Engines Visible:

10.13.9.189

WCCP Cache Engines NOT Visible:

-none-

If the “Cache Engines Visible” contains “-none-”, there is no communications over the control connection.

- b. Run the `show ip wccp <service_id>` command to obtain a list of all routers and IWSVA systems. Unless another service value was selected, the default Service ID should be 80.

```
Router# show ip wccp 80
```

Global WCCP information:

Router information:

**Router Identifier:** 10.13.10.17

Protocol Version: 2.0

Service Identifier: web-cache

**Number of Cache Engines:** 1

Number of routers: 1

Total Packets Redirected: 0



```
Redirect access-list: -none-
Total Packets Denied Redirect: 0
Total Packets Unassigned: 0
Group access-list: -none-
Total Messages Denied to Group: 0
Total Authentication failures: 0
```

The router identifier is the Cisco router's IP address that the IWSVA sees. This address is not necessarily the router interface that the redirected traffic uses to reach the cache, but the IP address displayed needs to be reachable by IWSVA.

The Total Packets Unassigned value is the number of packets that were not redirected due to a lack of assignment to an IWSVA device. The redirection failure can happen during the initial discovery of the IWSVA device or if the IWSVA is unavailable for short periods of time - such as being down for maintenance or services being restarted.

## Checking the WCCP Registration Activity

Perform the following steps on the Cisco device to validate the WCCP registration activity.

### To validate the WCCP registration activity:

1. Run the **show ip wccp 80 view** command to obtain a list of routers and IWSVA systems. This example assumes that the service ID is left at the default value of 80.
2. If the Cisco device is unable to “partner” with IWSVA, you will need to enable the debug capabilities to expose the WCCP activity on the Cisco device. The debug commands to enable the WCCP events and packets are:

```
debug ip wccp events
debug ip wccp packets
```

You should enable the debug commands as shown in the example below after you have configured the IWSVA device and the Cisco device for WCCP. The debug will show the WCCP communication sessions between the two devices.

3. Log into the Cisco device's console as the administrative user and perform the following:

a. Router# **debug ip wccp event**

WCCP events debugging is on.

b. Router# **debug ip wccp packet**

WCCP packet info debugging is on

The Cisco device will display the results of the packet debug as follows:

```
Router#
2d18h: WCCP-EVNT:S00: Built new router view: 0 routers, 0 usable web caches, change
00000001
2d18h: %SYS-5-CONFIG_I: Configured from console by console
2d18h: WCCP-PKT:S00: Sending I_See_You packet to 192.168.15.2 w/ rcv_id 00000001
2d18h: WCCP-EVNT:S00: Redirect_Assignment packet from 192.168.15.2 fails source
check
2d18h: %WCCP-5-SERVICEFOUND: Service web-cache acquired on Web Cache
192.168.15.2
2d18h: WCCP-PKT:S00: Received valid Here_I_Am packet from 192.168.15.2 w/rcv_id
00000001
2d18h: WCCP-EVNT:S00: Built new router view: 1 routers, 1 usable web caches, change
00000002
2d18h: WCCP-PKT:S00: Sending I_See_You packet to 192.168.15.2 w/ rcv_id 00000002
2d18h: WCCP-EVNT:S00: Built new router view: 1 routers, 1 usable web caches, change
00000002
2d18h: WCCP-PKT:S00: Received valid Redirect_Assignment packet from 192.168.15.2
w/rcv_id
00000002
2d18h: WCCP-PKT:S00: Sending I_See_You packet to 192.168.15.2 w/ rcv_id 00000003
2d18h: WCCP-EVNT:S00: Built new router view: 1 routers, 1 usable web caches, change
00000002
2d18h: WCCP-PKT:S00: Received valid Redirect_Assignment packet from 192.168.15.2 w/rcv_id
00000003
2d18h: WCCP-PKT:S00: Sending I_See_You packet to 192.168.15.2 w/ rcv_id 00000004
2d18h: WCCP-PKT:S00: Sending I_See_You packet to 192.168.15.2 w/ rcv_id 00000005
2d18h: WCCP-PKT:S00: Sending I_See_You packet to 192.168.15.2 w/ rcv_id 00000006
2d18h: WCCP-EVNT:S00: Built new router view: 1 routers, 1 usable web caches, change
00000002
2d18h: WCCP-PKT:S00: Received valid Redirect_Assignment packet from 192.168.15.2 w/rcv_id
00000006
```

## What to Look for in the Packet Debug

Whenever the Cisco device receives a “Here I Am” packet from the cache (IWSVA), the Cisco device answers with an “I See You” packet. You should see the responses as illustrated in the previous example above if your IWSVA is communicating properly with the Cisco device.

In a production environment, there may be a lot of other chatter that may make deciphering of the debug difficult. In order to filter the debug traffic and highlight the appropriate IP address for faster troubleshooting, use an ACL to restrict the debug capture to packets that only have the IWSVA IP address as the source address.

The example below shows how an ACL is used to zero in on the IWSVA IP address.

1. Execute the two commands show below to configure an ACL on the IWSVA IP address(es) and enable the debug process.

```
Router(config)# access-list 130 permit ip host 192.168.15.2
host 192.168.15.1
```

```
Router# debug ip packet 130
```

The following illustration shows an example of a filtered debug packet trace using the IWSVA IP address.

```
IP packet debugging is on for access list 130
2d19h: WCCP-EVNT:S00: Built new router view: 1 routers, 1 usable web caches, change
00000002
2d19h: WCCP-PKT:S00: Received valid Redirect_Assignment packet from 192.168.15.2
w/rcv_id 0000001B
2d19h: datagramsize=174, IP 18390: s=192.168.15.2 (Vlan300), d=192.168.15.1 (Vlan300),
totlen 160, fragment 0, fo 0, rcvd 3
2d19h: WCCP-PKT:S00: Sending I_See_You packet to 192.168.15.2 w/ rcv_id 0000001C
2d19h: datagramsize=174, IP 18392: s=192.168.15.2 (Vlan300), d=192.168.15.1 (Vlan300),
totlen 160, fragment 0, fo 0, rcvd 3
2d19h: WCCP-PKT:S00: Sending I_See_You packet to 192.168.15.2 w/ rcv_id 0000001D
2d19h: datagramsize=174, IP 18394: s=192.168.15.2 (Vlan300), d=192.168.15.1 (Vlan300),
totlen 160, fragment 0, fo 0, rcvd 3
2d19h: WCCP-PKT:S00: Sending I_See_You packet to 192.168.15.2 w/ rcv_id 0000001E
2d19h: datagramsize=378, IP 18398: s=192.168.15.2 (Vlan300), d=192.168.15.1 (Vlan300),
totlen 364, fragment 0, fo 0, rcvd 3
2d19h: WCCP-EVNT:S00: Built new router view: 1 routers, 1 usable web caches, change
00000002
2d19h: WCCP-PKT:S00: Received valid Redirect_Assignment packet from 192.168.15.2
w/rcv_id 0000001E
```

```
2d19h: datagramsize=174, IP 18402: s=192.168.15.2 (Vlan300), d=192.168.15.1 (Vlan300),
totlen 160, fragment 0, fo 0, rcvd 3
2d19h: WCCP-PKT:S00: Sending I_See_You packet to 192.168.15.2 w/ rcv_id 0000001F
2d19h: datagramsize=174, IP 18404: s=192.168.15.2 (Vlan300), d=192.168.15.1 (Vlan300),
totlen 160, fragment 0, fo 0, rcvd 3
2d19h: WCCP-PKT:S00: Sending I_See_You packet to 192.168.15.2 w/ rcv_id 00000020
2d19h: datagramsize=174, IP 18406: s=192.168.15.2 (Vlan300), d=192.168.15.1 (Vlan300),
totlen 160, fragment 0, fo 0, rcvd 3
2d19h: WCCP-PKT:S00: Sending I_See_You packet to 192.168.15.2 w/ rcv_id 00000021
2d19h: datagramsize=378, IP 18410: s=192.168.15.2 (Vlan300), d=192.168.15.1 (Vlan300),
totlen 364, fragment 0, fo 0, rcvd 3
2d19h: WCCP-EVNT:S00: Built new router view: 1 routers, 1 usable web caches, change
00000002
2d19h: WCCP-PKT:S00: Received valid Redirect_Assignment packet from 192.168.15.2
w/rcv_id 00000021
2d19h: datagramsize=174, IP 18414: s=192.168.15.2 (Vlan300), d=192.168.15.1 (Vlan300),
totlen 160, fragment 0, fo 0, rcvd 3
2d19h: WCCP-PKT:S00: Sending I_See_You packet to 192.168.15.2 w/ rcv_id 00000022
2d19h: datagramsize=174, IP 18416: s=192.168.15.2 (Vlan300), d=192.168.15.1 (Vlan300),
totlen 160, fragment 0, fo 0, rcvd 3
```

## What to Look for in the Packet Debug

If the router sees no IWSVA or WCCP activity, check the basic connectivity between the two devices. Try to ping IWSVA from the router or the router from the IWSVA device. If the pings work, verify that the configuration on the router is correct.

If the **cache acquisition** occurs but there is no packet redirection, verify that traffic actually reaches the router. Also, verify that traffic is being forwarded to the correct Cisco device interface. This was configured during the traffic redirection steps in the examples above. Note that the interception and redirection traffic goes to TCP port 80.

If the **cache acquisition** occurs and you see the redirection of packets but your clients cannot browse the Internet, check the IWSVA device's connectivity to the Internet and to your clients. From the IWSVA's console management screen, try pinging some IP addresses on the public Internet and to some of your clients on the internal network.

## Checking the Packet Redirection

Perform the following steps on the Cisco device to validate the packet redirection activity to ensure that packets are being forwarded properly.

**To validate the packet redirection activity:**

1. Log into your Cisco device's console as the administrative user.
2. Run the **show ip wccp 80 detail** command to obtain the redirection statistics from the Cisco device. This example assumes that the service ID is set to the default of 80.

```
Router# show ip wccp 80 detail

WCCP Cache-Engine information:
Web Cache ID: 10.13.9.189
Protocol Version: 2.0
State: Usable
Redirection: GRE
Initial Hash Info: 00000000000000000000000000000000
00000000000000000000000000000000
Assigned Hash Info: FFFFFFFFFFFFFFFFFFFFFFFFFFFFFFFF
FFFFFFFFFFFFFFFFFFFFFFFFFFFFFFFFFFFF
Hash Allotment: 256 (100.00%)
Packets Redirected: 736
Connect Time: 00:07:45
```

The Redirection parameter shows the packet redirection protocol used between the Cisco device and the cache (IWSVA). The redirection protocol can be set to Generic Routing Encapsulation (GRE) or Layer 2 (L2). GRE tunnels the communications and creates a point-to-point connection to allow devices to communicate over an IP network. L2 redirection on the other hand sends the packets directly to the cache (IWSVA) without encapsulating it first - but this requires the Cisco device and the IWSVA to be on the same Layer 2 network.

The Hash Allotment is the number of hash buckets assigned to the IWSVA. The Hex values show the Hash Allotment with Initial Hash Info and Assigned Hash Info values. The hash algorithm allows the collection and division of all the possible destination Internet addresses within a number of buckets. Each IWSVA device in the defined service group receives a percentage of the preset buckets. WCCP dynamically manages these resources according to the load and other preset conditions. If IWSVA is the only cache device defined, WCCP will assign all bucket resources to the IWSVA unit.

When the Cisco device starts the redirection of packets to the Cache Engine (IWSVA), you should see an increase in the value of the “Packets Redirected” field.

## Verifying the Packet Flow on IWSVA

If the forward method is set to GRE and the packets are redirected from the Cisco device, but are not being received by the IWSVA scanning daemons (based on the http.log file in the /etc/iscan/log directory), check the following IWSVA settings.

---

**Note:** For L2 forward method deployments, skip to step 2 and proceed to step 3.

---

### To verify the packet flow on IWSVA:

1. Log into the IWSVA console as the root user.
2. For GRE forward method deployments, use the **ifconfig** command to verify that the “gre1” device is operating correctly.

- bash - 3.2# ifconfig

```
/ # ifconfig
...
gre1 Link encap:UNSPEC HWaddr 0A-0D-09-BD-00-00-00-00-00-00-00-00-00-00-00-00
 inet addr:10.13.9.189 P-t-P:10.13.9.189 Mask:255.255.255.255
 UP POINTOPOINT RUNNING NOARP MTU:1476 Metric:1
 RX packets:50 errors:0 dropped:0 overruns:0 frame:0
 TX packets:0 errors:0 dropped:0 overruns:0 carrier:0
 collisions:0 txqueuelen:0
 RX bytes:5110 (4.9 KiB) TX bytes:0 (0.0 b)
...
/ #
```

**FIGURE F-9.** Use the **ifconfig** command to verify that the “gre1” device is operating correctly

3. Use the **iptunnel** command to verify that the IP tunnel from the router to IWSVA is configured.

```
-bash-3.2# iptunnel
```

```
-bash-3.2# iptunnel
gre0: gre/ip remote any local any ttl inherit noipmtudisc
gre1: gre/ip remote 10.204.170.254 local 10.204.170.97 dev eth0 ttl inherit
-bash-3.2#
```

**FIGURE F-10.** Use the `iptunnel` command to verify that the IP tunnel is configured.

4. Use the `iptables` command to verify that the IWSVA firewall is redirecting the packets to the scanning daemons.

```
-bash-3.2# iptables -t nat -vL
```

```
-bash-3.2# iptables -t nat -vL
Chain PREROUTING [policy ACCEPT 4811 packets, 455K bytes]
pkts bytes target prot opt in out source destination
1 48 C_WCCP tcp -- any any anywhere anywhere

Chain POSTROUTING [policy ACCEPT 4387 packets, 247K bytes]
pkts bytes target prot opt in out source destination

Chain OUTPUT [policy ACCEPT 4387 packets, 247K bytes]
pkts bytes target prot opt in out source destination

Chain C_WCCP (1 references)
pkts bytes target prot opt in out source destination
1 48 REDIRECT tcp -- gre1 any anywhere anywhere tcp dpt:4180 redir ports 8000
0 0 REDIRECT tcp -- gre1 any anywhere anywhere tcp dpt:4180 redir ports 21
0 0 REDIRECT tcp -- gre1 any anywhere anywhere tcp dpt:4180 redir ports 463
```

**FIGURE F-11.** Use the `iptables` command to verify that the IWSVA firewall is redirecting the packets

5. (Optional) As an “advanced” troubleshooting step, you can use the `tcpdump` command to capture packets from the IWSVA firewall. This will allow you to verify that IWSVA is processing the packets correctly.

- a. To limit the amount of data that is captured with the `tcpdump` packet capture command, configure the Cisco router with an ACL to limit the WCCP redirection to one client. This will allow you to decrease the scope and concentrate on a single client.

The example below shows how to restrict the WCCP redirection to one client (10.10.10.152) and start the WCCP redirection process.

```
Router(config)# access-list 50 permit 10.10.10.152
```

```
Router(config)# ip wccp web-cache redirect-list 50
```

- b. Enable the packet capture on the IWSVA using the **tcpdump** command. This is done from the IWSVA's console, and you must access the console as the “root” user.

```
-bash-3.2# tcpdump -s0 -w wccp.cap
```

- c. After capturing enough packets, stop the packet capture, and copy the wccp.cap file to your local host.
- d. Using a packet analysis tool such as Wireshark, open the wccp.cap file, and analyze the packet capture.
- e. Analyze the packet capture to see that the communications between the Cisco device and the IWSVA device are working properly.

---

**Note:** Using the tcpdump packet capture utility is an advanced concept and it may not be easy to decipher the communications between the Cisco and IWSVA device. If you have troubleshot up to this step and still cannot resolve the WCCP issue, you should contact Trend Micro's customer support department for more assistance.

---



# Appendix G

## URL Filtering Category Mapping

*Table G-1* shows the URL Filtering Category mapping differences between IWSVA 5.1 SP1 and 5.6/6.0

## URL Filtering Category Mapping Table.

**TABLE G-1. URL Category Mapping from IWSVA 5.1 to IWSVA 5.1 SP1/5.6/6.0**

<b>ID #</b>	<b>5.1 CATEGORY</b>	<b>5.1 SP1/5.6/6.0 CATEGORY</b>
23=Internet Radio and TV	Network Bandwidth	Network Bandwidth
72=Pay to Surf	Network Bandwidth	Network Bandwidth
57=Peer-to-peer	Network Bandwidth	Network Bandwidth
56=Personal Network Storage/File Download Server	Network Bandwidth	Network Bandwidth
43=Photo Searches	Network Bandwidth	Network Bandwidth
70=Ringtones/Mobile Phone Downloads	Network Bandwidth	Network Bandwidth
71=Software Downloads	Network Bandwidth	Network Bandwidth
69=Streaming Media/MP3	Network Bandwidth	Network Bandwidth
77=Adware	Internet Security	Internet Security
80=Cookies	Internet Security	Internet Security
81=Dialers	Internet Security	Internet Security
79=Disease Vector	Internet Security	Internet Security
82=Hacking	Internet Security	Internet Security
83=Joke Program	Internet Security	Internet Security
86=Made for AdSense	Internet Security	Internet Security
78=Malware Accomplice Formerly "Virus Accomplice"	Internet Security	Internet Security

**TABLE G-1. URL Category Mapping from IWSVA 5.1 to IWSVA 5.1 SP1/5.6/6.0 (Continued)**

<b>ID #</b>	<b>5.1 CATEGORY</b>	<b>5.1 SP1/5.6/6.0 CATEGORY</b>
84=Password Cracking	Internet Security	Internet Security
75=Phishing	Internet Security	Internet Security
73=Potentially Malicious Software	Internet Security	Internet Security
39=Proxy Avoidance	Internet Security	Internet Security
85=Remote Access Program	Internet Security	Internet Security
76=Spam	Internet Security	Internet Security
74=Spyware	Internet Security	Internet Security
88=Web Advertisement	Internet Security	Internet Security
42=Blogs/Web Communications (Formerly Web Communications)	Communication and Searches	Communication and Searches
51=Chat/Instant Messaging	Communication and Searches	Communication and Searches
52=Email (Formerly "Email related")	Communication and Searches	Communication and Searches
41=Internet Infrastructure (Formerly Infrastructure)	Communication and Searches	Communication and Searches
24=Internet Telephony	Communication and Searches	Communication and Searches
53=Newsgroups	Communication and Searches	Communication and Searches

**TABLE G-1. URL Category Mapping from IWSVA 5.1 to IWSVA 5.1 SP1/5.6/6.0 (Continued)**

<b>ID #</b>	<b>5.1 CATEGORY</b>	<b>5.1 SP1/5.6/6.0 CATEGORY</b>
40=Search Engines/Portals	Lifestyle	Communication and Searches
50=Social Networking	Communication and Searches	Communication and Searches
89=Web Hosting	Communication and Searches	Communication and Searches
16=Abortion	Adult	Adult
1=Adult/Mature Content	Adult	Adult
8=Alcohol/Tobacco	Adult	Adult
11=Gambling	Adult	Adult
25=Illegal Drugs	Adult	Adult
9=Illegal/Questionable	Adult	Adult
5=Intimate Apparel/Swimsuit	Adult	Adult
26=Marijuana	Adult	Adult
6=Nudity	Adult	Adult
3=Pornography	Adult	Adult
4=Sex Education	Adult	Adult
10=Tasteless	Adult	Adult
14=Violence/Hate/Racism	Adult	Adult
15=Weapons	Adult	Adult
59=Auctions	Business	Business

**TABLE G-1. URL Category Mapping from IWSVA 5.1 to IWSVA 5.1 SP1/5.6/6.0 (Continued)**

<b>ID #</b>	<b>5.1 CATEGORY</b>	<b>5.1 SP1/5.6/6.0 CATEGORY</b>
32=Brokerage/Trading	Business	Business
21=Business/Economy	Business	Business
31=Financial Services	Business	Business
45=Job Search/Careers	Business	Business
60=Real Estate	Business	Business
58=Shopping	Business	Business
38=Computers/Internet	Business	General
67=Vehicles	Business	General
30=Activist Groups	Lifestyle	Lifestyle
44=Alternative Journals	General	Lifestyle
19=Arts (Formerly Arts/ Entertainment)	Lifestyle	Lifestyle
22=Cult/Occult	Lifestyle	Lifestyle
29=Cultural Institutions	Lifestyle	Lifestyle
20=Entertainment (Formerly Arts/ Entertainment)	Lifestyle	Lifestyle
87=For Kids	General	Lifestyle
33=Games	Lifestyle	Lifestyle
62=Gay/Lesbian	Lifestyle	Lifestyle

**TABLE G-1. URL Category Mapping from IWSVA 5.1 to IWSVA 5.1 SP1/5.6/6.0 (Continued)**

<b>ID #</b>	<b>5.1 CATEGORY</b>	<b>5.1 SP1/5.6/6.0 CATEGORY</b>
63=Gun Clubs/Hunting	Lifestyle	Lifestyle
68=Humor (Formerly Humor/Jokes)	Lifestyle	Lifestyle
55=Personal Sites	Lifestyle	Lifestyle
47=Personals/Dating	Lifestyle	Lifestyle
18=Recreation/Hobbies	Lifestyle	Lifestyle
54=Religion	Lifestyle	Lifestyle
64=Restaurants/Food (Formerly Restaurants/Din- ing/Food)	Lifestyle	Lifestyle
61=Society/Lifestyle	Lifestyle	Lifestyle
65=Sports	Lifestyle	Lifestyle
76=Spam	Lifestyle	N/A
63=Sport Hunting and Gun Clubs	Lifestyle	N/A
66=Travel	Lifestyle	Lifestyle
38=Computers/Internet	General	General
27=Education	General	General
34=Government/Legal	General	General
37=Health	General	General

**TABLE G-1. URL Category Mapping from IWSVA 5.1 to IWSVA 5.1 SP1/5.6/6.0 (Continued)**

<b>ID #</b>	<b>5.1 CATEGORY</b>	<b>5.1 SP1/5.6/6.0 CATEGORY</b>
86=Made for AdSense sites (MFA)	General	N/A
35=Military	General	General
46=News/Media	General	General
36=Politics (Formerly Political)	General	General
49=Reference	General	General
48=Translators / Cached Pages (Formerly Translators (circumvent filtering))	General	General
67=Vehicles	N/A	General
90=Untested (Formerly Unrated)	General	General





# Appendix H

## URL Filtering Category Groups

URL categories are organized into the URL filtering groups shown in [Table H-1](#).

**TABLE H-1. Grouping Definition for URL Categories**

CATEGORY GROUP	DESCRIPTION
Adult	Websites generally considered inappropriate for children
Business	Websites related to business, employment, or commerce
Communications and Search	Websites that provide tools and services for online communications and searches.
General	Websites that do not fall into the other categories.
Internet Security	Potentially harmful websites, including those known to distribute malicious software
Lifestyle	Websites about religious, political, or sexual preferences, as well as recreation and entertainment
Network Bandwidth	Websites offering services that can significantly impact the speed of the computer's Internet connection
Untested	Websites that have not been classified under a category.

**Note:** For URL filtering to work correctly, the IWSVA must be able to send HTTP requests to the Trend Micro service. If an HTTP proxy is required, configure the proxy setting by choosing **Administration > Deployment Wizard**.

## URL Filtering Categories

*Table H-2* lists definitions of the URL filtering categories and the assigned group.

**TABLE H-2. URL Filtering Category Definitions**

CATEGORY GROUP	CATEGORY TYPE	CATEGORY DEFINITION
Adult	Abortion	Sites that promote, encourage, or discuss abortion, including sites that cover moral or political views on abortion
Adult	Adult/Mature Content	Sites with profane or vulgar content generally considered inappropriate for minors; includes sites that offer erotic content or ads for sexual services, but excludes sites with sexually explicit images
Adult	Alcohol/Tobacco	Sites that promote, sell, or provide information about alcohol or tobacco products
Adult	Gambling	Sites that promote or provide information on gambling, including online gambling sites
Adult	Illegal Drugs	Sites that promote, glamorize, supply, sell, or explain how to use illicit or illegal intoxicants
Adult	Illegal/Questionable	Sites that promote and discuss how to perpetrate nonviolent crimes, including burglary, fraud, intellectual property theft, and plagiarism; includes sites that sell plagiarized or stolen materials

**TABLE H-2. URL Filtering Category Definitions (Continued)**

<b>CATEGORY GROUP</b>	<b>CATEGORY TYPE</b>	<b>CATEGORY DEFINITION</b>
Adult	Intimate Apparel/ Swimsuit	Sites that sell swimsuits or intimate apparel with models wearing them
Adult	Marijuana	Sites that discuss the cultivation, use, or preparation of marijuana, or sell related paraphernalia
Adult	Nudity	Sites showing nude or partially nude images that are generally considered artistic, not vulgar or pornographic
Adult	Pornography	Sites with sexually explicit imagery designed for sexual arousal, including sites that offer sexual services
Adult	Sex Education	Sites with or without explicit images that discuss reproduction, sexuality, birth control, sexually transmitted disease, safe sex, or coping with sexual trauma
Adult	Tasteless	Sites with content that is gratuitously offensive and shocking; includes sites that show extreme forms of body modification or mutilation and animal cruelty
Adult	Violence/ Hate/ Racism	Sites that promote hate and violence; includes sites that espouse prejudice against a social group, extremely violent and dangerous activities, mutilation and gore, or the creation of destructive devices
Adult	Weapons	Sites about weapons, including their accessories and use; excludes sites about military institutions or sites that discuss weapons as sporting or recreational equipment

**TABLE H-2. URL Filtering Category Definitions (Continued)**

<b>CATEGORY GROUP</b>	<b>CATEGORY TYPE</b>	<b>CATEGORY DEFINITION</b>
Business	Auctions	Sites that serve as venues for selling or buying goods through bidding, including business sites that are being auctioned
Business	Brokerage/Trading	Sites about investments in stocks or bonds, including online trading sites; includes sites about vehicle insurance
Business	Business/Economy	Sites about business and the economy, including entrepreneurship and marketing; includes corporate sites that do not fall under other categories
Business	Financial Services	Sites that provide information about or offer basic financial services, including sites owned by businesses in the financial industry
Business	Job Search/Careers	Sites about finding employment or employment services
Business	Real Estate	Sites about real estate, including those that provide assistance selling, leasing, purchasing, or renting property
Business	Shopping	Sites that sell goods or support the sales of goods that do not fall under other categories; excludes online auction or bidding sites
Communications and Search	Blogs/Web Communications	Blog sites or forums on varying topics or topics not covered by other categories; sites that offer multiple types of web-based communication, such as e-mail or instant messaging
Communications and Search	Chat/Instant Messaging	Sites that provide web-based services or downloadable software for text-based instant messaging or chat

**TABLE H-2. URL Filtering Category Definitions (Continued)**

<b>CATEGORY GROUP</b>	<b>CATEGORY TYPE</b>	<b>CATEGORY DEFINITION</b>
Communications and Search	Email	Sites that provide email services, including portals used by companies for web-based email
Communications and Search	Internet Infrastructure	Content servers, image servers, or sites used to gather, process, and present data and data analysis, including web-based analytics tools and network monitors
Communications and Search	Internet Telephony	Sites that provide web services or downloadable software for Voice over Internet Protocol (VoIP) calls
Communications and Search	Newsgroups	Sites that offer access to Usenet or provide other newsgroup, forum, or bulletin board services
Communications and Search	Search Engines/ Portals	Search engine sites or portals that provide directories, indexes, or other retrieval systems for the web
Communications and Search	Social Networking	Sites devoted to personal expression or communication, linking people with similar interests
Communications and Search	Web Hosting	Sites of organizations that provide top-level domains or web hosting services
General	Computers/ Internet	Sites about computers, the Internet, or related technology, including sites that sell or provide reviews of electronic devices
General	Education	School sites, distance learning sites, and other education-related sites

**TABLE H-2. URL Filtering Category Definitions (Continued)**

<b>CATEGORY GROUP</b>	<b>CATEGORY TYPE</b>	<b>CATEGORY DEFINITION</b>
General	Government/ Legal	Sites about the government, including laws or policies; excludes government military or health sites
General	Health	Sites about health, fitness, or well-being
General	Military	Sites about military institutions or armed forces; excludes sites that discuss or sell weapons or military equipment
General	News/Media	Sites about the news, current events, contemporary issues, or the weather; includes online magazines whose topics do not fall under other categories
General	Politics	Sites that discuss or are sponsored by political parties, interest groups, or similar organizations involved in public policy issues; includes non-hate sites that discuss conspiracy theories or alternative views on government
General	Reference	General and specialized reference sites, including map, encyclopedia, dictionary, weather, how-to, and conversion sites
General	Translators/ Cached Pages	Online page translators or cached Web pages (used by search engines), which can be used to circumvent proxy servers and Web filtering systems
General	Untested	Sites that have not been classified under a category
General	Vehicles	Sites about motorized transport, including customization, procurement of parts and actual vehicles, or repair services; excludes sites about military vehicles

TABLE H-2. URL Filtering Category Definitions (Continued)

CATEGORY GROUP	CATEGORY TYPE	CATEGORY DEFINITION
Internet Security	Adware	Sites with downloads that display advertisements or other promotional content; includes sites that install browser helper objects (BHOs)
Internet Security	Cookies	Sites that send malicious tracking cookies to visiting web browsers
Internet Security	Dialers	Sites with downloads that dial into other networks or premium-rate telephone numbers without user consent
Internet Security	Disease Vector	Sites that directly or indirectly facilitate the distribution of malicious software or source code
Internet Security	Hacking	Sites that provide downloadable software for bypassing computer security systems
Internet Security	Joke Program	Sites that provide downloadable "joke" software, including applications that can unsettle users
Internet Security	Made for AdSense sites (MFA)	Sites that use scraped or copied content to pollute search engines with redundant and generally unwanted results
Internet Security	Malware Accomplice	Sites used by malicious programs, including sites used to host upgrades or store stolen information
Internet Security	Password Cracking	Sites that distribute password cracking software
Internet Security	Phishing	Fraudulent sites that mimic legitimate sites to gather sensitive information, such as user names and passwords

**TABLE H-2. URL Filtering Category Definitions (Continued)**

<b>CATEGORY GROUP</b>	<b>CATEGORY TYPE</b>	<b>CATEGORY DEFINITION</b>
Internet Security	Potentially Malicious Software	Sites that contain potentially harmful downloads
Internet Security	Proxy Avoidance	Sites about bypassing proxy servers or web filtering systems, including sites that provide tools for that purpose
Internet Security	Remote Access Program	Sites that provide tools for remotely monitoring and controlling computers
Internet Security	Spam	Sites whose addresses have been found in spam messages
Internet Security	Spyware	Sites with downloads that gather and transmit data from computers owned by unsuspecting users
Internet Security	Web Advertisement	Sites dedicated to displaying advertisements, including sites used to display banner or pop-up ads
Lifestyle	Activist Groups	Sites that promote change in public policy, public opinion, social practice, economic activities, or economic relationships; includes sites controlled by service, philanthropic, professional, or labor organizations
Lifestyle	Alternative Journals	Online equivalents of supermarket tabloids and other fringe publications
Lifestyle	Arts	Sites about visual arts, such as painting and sculpture.
Lifestyle	Cult/Occult	Sites about alternative religions, beliefs, and religious practices, including those considered cult or occult



**TABLE H-2. URL Filtering Category Definitions (Continued)**

CATEGORY GROUP	CATEGORY TYPE	CATEGORY DEFINITION
Lifestyle	Cultural Institutions	Sites controlled by organizations that seek to preserve cultural heritage, such as libraries or museums; also covers sites owned by the Boy Scouts, the Girl Scouts, Rotary International, and similar organizations
Lifestyle	Entertainment	Sites that promote or provide information about movies, music, non-news radio and television, books, humor, or magazines
Lifestyle	For Kids	Sites designed for children
Lifestyle	Games	Sites about board games, card games, console games, or computer games; includes sites that sell games or related merchandise
Lifestyle	Gay/Lesbian	Sites about gay, lesbian, transgender, or bisexual lifestyles
Lifestyle	Gun Clubs/ Hunting	Sites about gun clubs or similar groups; includes sites about hunting, war gaming, or paintball facilities
Lifestyle	Humor	Sites intended for humor.
Lifestyle	Personal Sites	Sites maintained by individuals about themselves or their interests; excludes personal pages in social networking sites, blog sites, or similar services
Lifestyle	Personals/ Dating	Sites that help visitors establish relationships, including sites that provide singles listings, matchmaking, or dating services

**TABLE H-2. URL Filtering Category Definitions (Continued)**

<b>CATEGORY GROUP</b>	<b>CATEGORY TYPE</b>	<b>CATEGORY DEFINITION</b>
Lifestyle	Recreation/ Hobbies	Sites about recreational activities and hobbies, such as collecting, gardening, outdoor activities, traditional (non-video) games, and crafts; includes sites about pets, recreational facilities, or recreational organizations
Lifestyle	Religion	Sites about popular religions, their practices, or their places of worship
Lifestyle	Restaurants/ Food	Sites that list, review, discuss, advertise, or promote food, catering, dining services, cooking, or recipes
Lifestyle	Society/ Lifestyle	Sites that provide information about life or daily matters; excludes sites about entertainment, hobbies, sex, or sports, but includes sites about cosmetics or fashion
Lifestyle	Sports	Sites about sports or other competitive physical activities; includes fan sites or sites that sell sports merchandise
Lifestyle	Travel	Sites about travelling or travel destinations; includes travel booking and planning sites
Network Bandwidth	Internet Radio and TV	Sites that primarily provide streaming radio or TV programming; excludes sites that provide other kinds of streaming content
Network Bandwidth	Pay to Surf	Sites that compensate users who view certain websites, email messages, or advertisements or users who click links or respond to surveys
Network Bandwidth	Peer-to-Peer	Sites that provide information about or software for sharing and transferring files within a peer-to-peer (P2P) network

**TABLE H-2. URL Filtering Category Definitions (Continued)**

<b>CATEGORY GROUP</b>	<b>CATEGORY TYPE</b>	<b>CATEGORY DEFINITION</b>
Network Bandwidth	Personal Network Storage/File Download Servers	Sites that provide personal online storage, backup, or hosting space, including those that provide encryption or other security services
Network Bandwidth	Photo Searches	Sites that primarily host images, allowing users to share, organize, store, or search for photos or other images
Network Bandwidth	Ringtones/Mobile Phone Downloads	Sites that provide content for mobile devices, including ringtones, games, or videos
Network Bandwidth	Software Downloads	Sites dedicated to providing free, trial, or paid software downloads
Network Bandwidth	Streaming Media/ MP3	Sites that offer streaming video or audio content without radio or TV programming; sites that provide music or video downloads, such as MP3 or AVI files



# Appendix I

## Application List

TABLE I-1. Application List

<b>ANTIVIRUS</b>	<b>DESCRIPTION</b>	<b>SUPPORTED APPLICATIONS</b>
Sophos update	Sophos antivirus update protocol.	7.3
ZoneAlarm Updates	Contains web traffic designated to the hosts "zonealarm.com" and "zonelabs.com", or associated to the SSL Common Name "cm1.zonealarm.com".	ZoneAlarm Extreme Security Edition 9.3
<b>APPLICATION SERVICE</b>	<b>DESCRIPTION</b>	<b>SUPPORTED APPLICATIONS</b>
ActiveSync	Microsoft ActiveSync is a mobile data synchronization technology and protocol developed by Microsoft, originally released in 1996	

**TABLE I-1. Application List (Continued)**

Apple App Store	The Apple App Store is a digital application distribution platform for iOS developed and maintained by Apple Inc.	
Apple Push Notification Service	APNS (Apple Push Notification Service) is an Apple service which forwards notifications from the servers of third party applications to iOS devices.	
Dictionary Server Protocol	The DICT protocol is a TCP transaction based query/response protocol that enables a client to access dictionary definitions from a set of natural language dictionary databases.	
End Point Mapper	End Point Mapper is a protocol used by Exchange to determine the ports used by various services.	
Google Play	Google Play (formerly Android Market) is an online software store developed by Google for Android OS devices.	
iCloud	iCloud is a cloud computing service developed by Apple Inc. which allows to store and share data, from an iOS mobile (iPhone, iPad, iPod Touch) or a Macintosh.	1.0.1
iOS OTA Update	iOS OTA Update is the protocol used for iOS updates Over The Air.	

**TABLE I-1. Application List (Continued)**

Lightweight Directory Access Protocol (LDAP)	LDAP (Lightweight Directory Access Protocol) is a protocol used for accessing directory services. Windows environment use this protocol to send queries to Active Directory.	
Microsoft Office Groove	Microsoft Office Groove is a desktop application designed for document collaboration in teams with members who are regularly off-line or who do not share the same network security clearance.	
Name Service Provider Interface	Name Service Provider Interface is a protocol used by Exchange.	
Perforce Protocol	Perforce is a commercial, proprietary, centralized revision control system developed by Perforce Software, Inc.	2010.2
Port Mapper	Port Mapper protocol maps RPC program and version numbers to port numbers. This program makes dynamic binding of remote programs possible.	
Samsung Apps	Samsung Apps is an application store for Samsung mobile and TV users.	2.6.148
SAP	SAP is both a protocol and the name of an ERP application used by most companies.	

**TABLE I-1. Application List (Continued)**

Secure LDAP	Secure version of the LDAP protocol.	
Service Location Protocol	Service Location Protocol is a decentralized, lightweight, scalable and extensible protocol for service discovery within a site.	
Simple Service Discovery Protocol (SSDP)	Simple Service Discovery Protocol (SSDP) provides a mechanism whereby network clients can discover desired network services.	
Syslog	Syslog protocol is used for the transmission of event notification messages across networks between a client and a server.	
Websphere Message Queue series	MQ (IBM Websphere MQ) is an inter-application communication protocol.	
Windows Phone Marketplace	Windows Phone Marketplace is a service by Microsoft for its Windows Phone 7 platform that allows users to browse and download applications that have been developed by third-parties.	Windows Phone 7 (20120308)
X Font Server protocol	X Font Server is a standard communication protocol between an X server and a font renderer.	2.0



TABLE I-1. Application List (Continued)

AUDIO/VIDEO	DESCRIPTION	SUPPORTED APPLICATIONS
050plus	050 plus is a Japanese embedded smart phone application dedicated to audio-conferencing.	2.0.4
Adobe Connect	Adobe Connect is a web communication system web for the training, the marketing, the conferences and the online collaboration.	
Apple FaceTime	FaceTime is an Apple video calling software which runs on iOS based mobile devices.	
BBC Player	BBC Player is a in-browser live video streaming service.	
Blip.tv	Blip.tv is a TV Series video streaming website.	
Blockbuster	This protocol contains web traffic to the host ".blockbuster.com".	
Cisco Meeting-Place	MeetingPlace is a protocol used by the Cisco Unified MeetingPlace suite of voice, web, and video conferencing products.	
CNET TV	CNET TV is a video streaming website related to new technologies.	

**TABLE I-1. Application List (Continued)**

Flash	Flash is a dynamic HTTP streaming protocol used to access video contents from a client using Flash Media Playback.	
gotomeeting - online meeting service (Citrix)	online meeting service (Citrix)	GotoMeeting v4.8.0.708
Grooveshark	Grooveshark has unlimited service listening to music online.	
H225	The H225 Protocol is a VoIP protocol, used for call signaling and RAS (Registration, Admission and Status).	
H245	H245 is a VoIP protocol, used for call signaling codec negotiation.	
h248 Protocol in binray mode	h248 Protocol (Megaco) in binary mode.	
h248 Protocol in text mode	h248 Protocol (Megaco) in text mode.	
HBO GO	This protocol contains web traffic to the host ".hbogo.com".	
Howcast	This protocol contains web traffic to the host ".howcast.com".	
Hulu	This protocol contains web traffic to the host ".hulu.com".	

**TABLE I-1. Application List (Continued)**

icall	icall is proprietary voice/video over IP protocol.	
Icecast	Icecast is a protocol used to stream audio files over HTTP.	
iKU	iKU is an online video player which supports video upload, download and format conversion.	20120420
Inter Asterisk eXchange	Inter Asterisk eXchange (IAX2) is a data exchange protocol between Asterisk servers.	
iQiyi	iQiyi is one of the biggest Chinese websites that allows users to watch TV programs, movies and animations via network. It provides an application so watching videos would be more easily.	20120529
iTunes	iTunes is a Apple's proprietary digital media player application, used for playing and organizing digital music and video files.	
KeyHole Generic		
KeyHoleTv	a public site, Using P2P technology for retransmission of television broadcast keyholetv software,	

**TABLE I-1. Application List (Continued)**

KeyHoleVideo		
Media Gateway Control Protocol	MGCP protocol is used as signaling protocol for voice IP applications.	
Message Session Relay Protocol (MSRP)	Message Session Relay Protocol (MSRP) is a protocol for transmitting instant messages, defined by RFC 4975.	rfc 4975
Metacafe	This protocol contains web traffic to the hosts ".metacafe.com", "v.mccont.com" and ".mcstatic.com".	
Microsoft Multimedia Streaming (MMS)	MMS protocol is used extensively today by Microsoft video streaming servers. It enables to stream a file in real time to many simultaneous viewers.	Media Player
Mpeg 2 Transmission	MPEG-Transport Stream is a protocol used for MPEG flows transmission	
MSN Video	This protocol is used by MSN Messenger for video conversations.	
Netflix	Netflix is an online movie service.	
Paltalk audio chat	Proprietary protocol used by Paltalk in audio chats	

**TABLE I-1. Application List (Continued)**

Paltalk video	Proprietary protocol used by Paltalk in video.	8.1 8.5 9.0 9.1 9.4 10.0
PPLive	PPLive is an application intended to watch TV in peer to peer	
ppStream - P2P based Streamed Media (PPStream)	The ppstream protocol provides audio and video streaming. It is based on BitTorrent (peer to peer) technology. It is mainly used in China.	
Q931	The Q.931 protocol enables the use of voice and image on networks for video conferencing. It provides no flow control, however, or retransmission, since the underlying layers are assumed to be reliable and the circuit-oriented nature of ISDN allocates bandwidth in fixed increments of 64 kbps. Q.931 does manage connection setup and close. Like TCP, Q.931 documents both the protocol itself and a state machine.	
QQLive network player	QQLive is an application intended to watch TV in peer-to-peer.	2010 2011
QQmusic	Contains web traffic designated to the host "stream.qqmusic.qq.com".	

**TABLE I-1. Application List (Continued)**

QVOD Player	QVOD Player is a free video downloader and player based on P4P (Proactive network Provider Participation for P2) . QVOD Player can download and play the same video at the same time.	5.1.108
Real Data Transport	This protocol is used to transport audio/video data.	
Real Time Control Protocol (RTCP)	The real-time transport Control protocol RTP allows monitoring of the data delivery in a manner scalable to large multicast networks, and to provide minimal control and identification functionality.	
Real Time Protocol (RTP)	The real-time transport protocol RTP provides end-to-end network transport functions suitable for applications transmitting real-time data, such as audio, video or simulation data, over multicast or unicast network services. RTP does not address resource reservation and does not guarantee quality-of-service for real-time services. The data transport is augmented by a control protocol (RTCP) to allow monitoring of the data delivery in a manner scalable to large multicast networks, and to provide minimal control and identification functionality. The protocol supports the use of RTP-level translators and mixers.	

**TABLE I-1. Application List (Continued)**

Real Time Streaming Protocol (RTSP)	The Real Time Streaming Protocol (RTSP) is an application-level protocol for control over the delivery of data with real-time properties. RTSP provides an extensible framework to enable controlled, on-demand delivery of real-time data, such as audio and video.	RealPlayer
Rhapsody	Rhapsody is a subscription-based music streaming service.	2.2.4-Android,2.2.10-iOS,20120611-web
Session Initiation Protocol (SIP)	Session Initiation Protocol (SIP) is the Internet Engineering Task Force's (IETF's) standard for multimedia conferencing over IP. Like other VoIP protocols, SIP is designed to address the functions of signaling and session management within a packet telephony network.	2
Shoutcast	Shoutcast is a protocol used to stream audio files over HTTP.	
Silverlight	Audio/Video stream based on Silverlight. Silverlight is a Microsoft web browser plugin designed to render programmable animations and to stream videos. It quite similar with Adobe Flash: animated vector graphics, H264 video streaming.	

**TABLE I-1. Application List (Continued)**

Skiny Client Control Protocol (Skinny)	Skiny Client Control Protocol (SCCP) is a Cisco proprietary protocol used between Cisco Call Manager and Cisco VOIP phones. It is also supported by some other vendors.	
Sky Player	Contains web traffic designated to the host "skyplayer.sky.com".	
Slacker Personal Radio	Slacker is an interactive Internet radio service available in the US and Canada.	
Slingbox	Slingbox is a streaming protocol over the Internet used to watch and control TV shows received from your home devices.	1.5.1.119
Sopcast	Sopcast is a video streaming service based on a peer-to-peer protocol : SOP (Streaming Over P2P).	3.2.9
SoundCloud	This protocol contains web traffic to the hosts "soundcloud.com" and "sndcdn.com", or associated to the SSL Common Names "api.soundcloud.com" and "sndcdn.com".	
Spotify	Spotify is a Swedish proprietary protocol for music streaming.	



**TABLE I-1. Application List (Continued)**

Tango Video Calls	Tango is an embedded smart phone application dedicated to audio/video-conference.	1.5.60
TTPlayer	Qianqian TTPlayer is a Windows based audio media player. It supports many kinds of audio formats such as MP3, MP4, WMV, WAVE...etc. It also supports searching lyrics on Internet automatically, and shows the results line by line while playing song. On July, 2006, TTPlayer was sold to Baidu.com.	5.8.1
TuneIn	This protocol contains web traffic to the hosts "tunein.com" and "radio-time.com".	
TVAnts Protocol	TVAnts is a P2P TV software, using the BitTorrent P2P technology. It provides a way to watch on the PC most cable and satellite as well as WebTV.	1.0.59
UUSee Protocol	Uusee is a P2P TV software, using the BitTorrent P2P technology. It provides a way to watch on the PC most cable and satellite as well as WebTV. It uses the network coding technology.	
VeohTV	VeohTV is a VOD streaming service which includes both client software and a website with embedded flash videos.	

**TABLE I-1. Application List (Continued)**

VEVO	VEVO is music video streaming website.	
Viber	Viber is a free embedded voice over-ip application, for smart phones.	1.1.0
voddler	Voddler is a streaming software.	
WebEx	WebEx is an online meeting, video conferencing and collaborative application.	Meeting Center 8.5 (WBS 27) - Client build 27.24.0.10113
Yahoo Messenger Video	This protocol is used by Yahoo Messenger for video conversations.	
Yahoo Screen	Yahoo Screen is a movie broadcast website.	
<b>AUTHENTICATION</b>	<b>DESCRIPTION</b>	<b>SUPPORTED APPLICATIONS</b>
Diameter	Diameter is an authentication, authorization and accounting protocol.	
Identification Protocol	The Identification Protocol provides a means to determine the identity of a user of a particular TCP connection.	

**TABLE I-1. Application List (Continued)**

Kerberos	Kerberos provides a means of verifying the identities of the different workstations on an open (unprotected) network.	
Remote Authentication Dial-In User Service (RADIUS)	RADIUS (Remote Authentication Dial-In User Service) is a client/server protocol that enables remote access servers to communicate with a central server to authenticate dial-in users and authorize their access to the requested system or service.	
SOCKSv4	Socks 4 is an authentication protocol.	
SOCKSv5	Socks 5 is an authentication protocol.	
TACACS+	TACACS+ (Terminal Access Controller Access-Control System Plus) is a Cisco Systems proprietary protocol which provides access control for routers, network access servers and other networked computing devices via one or more centralized servers.	1.78
Yellow Page Password	The Yellow Page Password protocol enables the modification of logins and passwords in Network Interface System cards.	
Yellow Pages Server	Yellow Pages Server is a protocol used to distribute NIS databases to client systems within an NIS domain.	

**TABLE I-1. Application List (Continued)**

<b>DATABASE</b>	<b>DESCRIPTION</b>	<b>SUPPORTED APPLICATIONS</b>
DB2 protocol	DB2 is a database from IBM which has its roots in the early 1980s. It runs on IBM mainframes and is also available for Linux/Unix/Windows.	9.7
Distributed Relational Database Architecture	DRDA is a protocol for carrying out SQL queries and commands.	
FileMaker Pro	FileMaker Pro is a relational database application from FileMaker Inc and which runs on Microsoft Windows as well as Mac OS.	
Informix protocol	Informix is a family of relational database management systems developed by IBM. IBM acquired the Informix technology in 2001 but it dates back to 1981. It runs on IBM mainframes and is also available for Linux/Unix/Windows.	11.70
Mobilink	Mobilink is a proprietary, binary, TCP based protocol which is used to synchronize the contents of multiple mobile client databases with a central SQL Server. The clients can run on smart phones, java applets, etc., in addition to PC computers.	12.0.1

**TABLE I-1. Application List (Continued)**

MySQL Protocol (MySQL)	MySQL is an open source relational database management system (RDBMS) that uses Structured Query Language (SQL), the most popular language for adding, accessing, and processing data in a database.	
Postgres	PostgreSQL is a sophisticated Object-Relational DBMS, supporting almost all SQL constructs, including subselects, transactions, and user-defined types and functions.	7.3 7.4 8.0 8.1 8.2
SQLI	The SQLI protocol (Structured Query Language Interface) is a proprietary protocol seemingly used exclusively in IBM Informix servers.	
Sybase	Sybase protocols are used to exchange messages (namely authentication and SQL queries) between database clients and servers developed by the Sybase Company.	
Tabular Data Stream (SQL Server)	TDS protocol is used to communicate between SQL applications and a SQL Server.	

**TABLE I-1. Application List (Continued)**

Transparent Network Service (Oracle)	Transparent Network Service (TNS) is the Oracle (version 8 or higher) networking technology that provides a single application interface to all industry-standard networking protocols. To connect to a database, users initiate a connect request by passing information (username and password) along with a short name for the database service they wish to connect to.	
<b>EMAIL</b>	<b>DESCRIPTION</b>	<b>SUPPORTED APPLICATIONS</b>
Internet Message Access Protocol version 4 (IMAPv4)	The IMAP protocol (Internet Message Access Protocol Version 4) enables a client to access and manipulate electronic mail messages on a server.	
Lotus Notes	Lotus Notes is a groupware knowledge management system which integrates various services such as web browsing, calendaring and mailing.	
MS Exchange Message API (MAPI)	MS Exchange Message API is a protocol used by Exchange clients to retrieve their emails.	
Post Office Protocol (POP3)	Post Office Protocol - Version 3 (POP3) allows a workstation to simply and dynamically access a mail stored on a mail server.	
Secure IMAP	IMAPS is the secure version of IMAP.	

**TABLE I-1. Application List (Continued)**

Secure POP3	Secure version of the POP3 protocol.	
Secure SMTP	Secure version of the SMTP protocol.	
Simple Mail Transfer Protocol (SMTP)	The Simple Mail Transfer Protocol (SMTP) is a protocol used for transferring mail reliably and efficiently.	
<b>ENCRYPTED</b>	<b>DESCRIPTION</b>	<b>SUPPORTED APPLICATIONS</b>
Internet Security Association and Key Management Protocol (ISAKMP)	The Internet Security Association and Key Management Protocol (ISAKMP) defines procedures and packet formats to establish, negotiate, modify and delete Security Associations (SA).	
IP secure (IPSec UDP)	IPSec protocol provides services for securing hosts communications. IPSec provides two security services: Authentication Header (AH), which allows authentication of the sender and Encapsulating Security Payload (ESP), which allows both authentication of the sender and encryption of data.	
Online Certificate Status Protocol	Network protocol used for validating certificate.	

**TABLE I-1. Application List (Continued)**

Secure Socket Layer (SSL)	Secure Sockets Layer (SSL) is a commonly-used protocol for managing the security of a message transmission on the Internet. SSL has recently been succeeded by Transport Layer Security (TLS), which is based on SSL.	
Tor	Tor is an application that intends to provide online anonymity.	
<b>FILE SERVER</b>	<b>DESCRIPTION</b>	<b>SUPPORTED APPLICATIONS</b>
aimini	Aimini is an online solution to store, send and share files.	
Cross File Transfer	File transfer software developed by Axway.	
File Transfer Protocol Data (FTP)	This protocol is used to transport data in data connection of FTP communication.	
File Transfer Protocol (FTP)	The FTP protocol is used for reliable data transfer between a client and a server.	
FTP over SSL	Secure version of the FTP protocol.	



**TABLE I-1. Application List (Continued)**

Gmail drive	GMAIL Drive is a Shell Namespace Extension that creates a virtual file system around your Google Mail account, allowing Gmail as a storage medium.	1.0.17
HotLine	HotLine protocol is used to upload/download file, tchat, get news about tchaters (not P2P a protocol).	
ibackup	ibackup is a online files backup protocol.	
Mount	The Mount protocol is separate from, but related to, the NFS protocol. It provides operating system specific services to launch the NFS protocol -- looking up server path names, validating user identity, and checking access permissions.	
NetBIOS	NetBIOS defines a software interface and standard methods providing a communication interface between the application program and the attached medium. NetBIOS is used in various LAN (Ethernet, Token Ring, etc) as well as WAN environments such TCP/IP, PPP and X.25 networks.	
Network File System (NFS)	NFS protocol provides transparent remote access to shared file systems across networks.	

**TABLE I-1. Application List (Continued)**

Network Lock Manager	The network lock manager is a facility that works in cooperation with the Network File System (NFS) to provide a System V style of advisory file and record locking over the network.	
Remote synchronous (file transfer)	Rsync is a protocol used by various services performing updates. It greatly speeds up the update process since only the differences between two sets of files are transferred, instead of the whole new file.	
Rquota	The RQuota protocol enables the implementation of quotas on remote machines. It is used in conjunction with the NFS protocol.	
Rstat	The RStat protocol is used in the Sun NFS family to exchange statistics on network activity.	
RUsers	The RUser's protocol provides a service that lists users currently logged on a remote server.	
Server Message Block (Windows File Server) (SMB)	The Server Message Block Protocol (SMB) provides a method for client applications to read and write to files and to request services from server programs in a computers network.	
Sync	The Sync protocol is an RPC service allowing data synchronization.	

**TABLE I-1. Application List (Continued)**

Trivial File Transfer Protocol (TFTP)	Trivial File Transfer Protocol (TFTP) is a file transfer protocol that is simpler to use than the File Transfer Protocol (FTP) but that proposes less features. TFTP uses the User Datagram Protocol (UDP) rather than the Transmission Control Protocol (TCP).	
Yellow Pages Update	The Yellow Pages Update protocol enables information updates in Network Information Services (NIS) cards.	
<b>FILE SHARING</b>	<b>DESCRIPTION</b>	<b>SUPPORTED APPLICATIONS</b>
firestorage	<a href="http://firestorage.jp/">http://firestorage.jp/</a> free file sharing service. You can choose from three type of plans. "non registered free plan", "registered free plan" and "registered fee-charging plan".	
<b>FILE TRANSFER</b>	<b>DESCRIPTION</b>	<b>SUPPORTED APPLICATIONS</b>
AIM Transfer Protocol	File transfer over AIM	>=6.5
IRC File Transfer Data	This protocol is used to transport data in IRC file transfer.	
Jabber File Transfer	Jabber transfer is an open standard to transfer file between 2 Jabber clients.	

**TABLE I-1. Application List (Continued)**

Meebo File Transfer	This protocol is used in order to transmit files from Meebo to other Instant Message Interfaces.	
PalTalk Transfer Protocol	PalTalk is an instant messaging protocol	9.4
QQ transfer Protocol	File transfer over QQ	QQ2003 EN QQ2005 V05.0.200.020 TM2008 Preview [34] QQ Beta3
Ymsg Transfer Protocol (Yahoo Messenger Transfer Protocol)	File transfer over ymsg	9.4
<b>FORUM</b>	<b>DESCRIPTION</b>	<b>SUPPORTED APPLICATIONS</b>
Google groups	Google groups	
Internet Relay Chat (IRC)	IRC (Internet Relay Chat) is an instant messaging protocol.	
Mibbit	Contains web traffic designated to the host "02.chat.mibbit.com", or associated to the SSL Common Names "web2.mibbit.com" and "chat.mibbit.com".	

**TABLE I-1. Application List (Continued)**

MSN groups	MSN Groups	20080129fr 20080129en
Network News Transport Protocol (NNTP)	The Network News Transport Protocol (NNTP) is used for the distribution, inquiry, retrieval and posting of net news articles using a reliable stream-based mechanism.	
Secure IRC	Secure IRC is the secure version of the IRC protocol.	
Secure NNTP	Secure version of the NNTP protocol.	
Windows Live groups	MSN Groups	20091231
Yahoo groups	Yahoo! Groups	20080123fr 20080123en 20090205fr 20090205en
<b>GAME</b>	<b>DESCRIPTION</b>	<b>SUPPORTED APPLICATIONS</b>
All Slots Casino	Contains web traffic designated to the host "setup.realgaming.com".	
CounterStrike	Network protocol used by Counter-Strike game and Steam.	
EVE Online	Eve Online is a multiplayer online game edited by CCP.	

**TABLE I-1. Application List (Continued)**

Half-Life and Half-Life 2	Half-Life and Half-Life 2 are two first-person shooter video games developed by Valve Corporation and provide on-line gaming features.	
IMVU	Contains web traffic designated to the host "imvu.com".	
JianXia III	This is a popular online game in China.	20120416
Lineage	Online game "Lineage" top page. MMORPG has been developed in Korea. In Japan, operated by NTT Japan Sea.	
Mabinogi: Heroes	Mabinogi: Heroes (aka in Mainland China) is a Korean online game developed by Nexon Korea Cooperation and licensed to Shanghai Posts & Telecommunications Technology Co., Ltd., in China. Its game service operator is Tiancity which is actually a brand of this Shanghai cooperation. In Shanghai , Guangdong , Shandong , Sichuan and Tianjin , there are game servers hosted by China Netcom (CNC and China Telecom ).	20120517
Nintendo Wi-Fi Connection	Wi-Fi Connection (WFC) is the Nintendo on-line gaming service for the Wii and DS video game systems.	

**TABLE I-1. Application List (Continued)**

Playstation Network	PlayStation Network (PSN) is the on-line gaming service for consoles made by Sony.	
Poker Stars	Salle de poker en ligne.	4.6.9.6_en 4.7.0.1_fr 4.6.9.8_es
QQGame	QQGame is an online game service developed by Tencent Technology . People can access this service through his/her QQ ID. The official web site is here: <a href="http://game.qq.com/">http://game.qq.com/</a>	20120427
Quake	Quake is a protocol allowing communication between Quake Clients and Quake servers.	
Steam	Steam is a digital distribution, digital rights management, multiplayer and communications platform developed by Valve Corporation.	
WiiConnect24	WiiConnect24 is an asynchronous communication protocol implemented on the Nintendo Wii gaming system. It used by some information channels and services embedded in the console, and by some games too.	
World of Warcraft	WOW is an online game.	3.2.2.10505

**TABLE I-1. Application List (Continued)**

Xbox Live	Online multiplayer gaming and digital media delivery service created and operated by Microsoft Corporation.	
<b>INSTANT MESSAGING</b>	<b>DESCRIPTION</b>	<b>SUPPORTED APPLICATIONS</b>
AIM express	AOL Web Instant Messaging	20090504
AirAIM	Contains web traffic designated to the host "airaim.com", or associated to the SSL Common Name "airaim.com".	
Aliwangwang	Aliwangwang is a free IM application developed by Taobao and Alibaba Group . Sellers and Buyers can use this application for business communication and other purposes, such as findings customers and publishing products info. Its conversation records can be used by Taobao to handle business argues.	7.00.20C
AOL Instant Messenger (AIM)	AIM is an instant messaging protocol. Originally, it meant 'AOL Instant Messenger'.	6.0 6.1 6.5 AgileMessenger IM+
Feixin 2012 Audio/Video Protocol		



**TABLE I-1. Application List (Continued)**

Fetion	Fetion ( <a href="http://feixin.10086.cn">http://feixin.10086.cn</a> ) is an instant message service provided by China Mobile. It provides message routing among kinds of client in different platforms, like windows PC, Web, smart phone, WAP and SMS.	4.7.1680
Fetion File	Detect file transfer through the Fetion protocol	4.7.3800
Fetion Web	This is the web version of Fetion.	20120502
FriendVox	Contains web traffic designated to the host "friendvox.com".	
Gadu Gadu	Gadu Gadu is a Polish instant messaging protocol.	
Gizmo Protocol	Gizmo is an instant messaging protocol.	
Google Chat (Gmail Chat)	Google web messenger	20090430
HOVRS	Contains web traffic designated to the hosts "i711.com" and "vrsws.hovrs.com", or associated to the SSL Common Name "vrsws.hovrs.com".	

**TABLE I-1. Application List (Continued)**

IBM Lotus Same-time	IBM Lotus Sametime is a client-server application and middleware platform that provides real-time, unified communications and collaboration for enterprises.	
ICQ2Go	Contains web traffic designated to the hosts "c.icq.com" and "api.icq.net".	
lloveIM	Contains web traffic designated to the host "iloveim.com".	
Jabber Protocol	Jabber is an open standard instant messaging and presence system.	jingle pidgin psi
Kaixin Chat	Contains web traffic designated to the host "kaixin001.com".	
kakaotalk	Introduction site on the smart phone apps, "cacao Talk".	
KoolIM	Contains web traffic designated to the host "koolim.com".	
Line	Line is a Japanese Instant Messaging and Voip application for smart phones and PCs. Call metadata is no more extracted from line, but can be raised from the SIP layer.	

**TABLE I-1. Application List (Continued)**

Meebo	This protocol is used for sending the user instant messages to the web site Meeboe.	
MessengerFX	Contains web traffic designated to the host "messengerfx.com".	
MS Communicator	Microsoft Office Communicator is a client software launched in October 2007 for conferences and which aims to communicate between collaborators using instant messaging, VoIP and video conference.	MS Communicator 2007 MS Communicator 2010
MSN live for Mobile	MSNMoblie is MSN instant messenger for mobile.	
MSN Messenger	The MSN protocol allows the exchange of instant messages. The MSN protocol is used by the Microsoft software Microsoft Messenger	4.7 6.5 7.5 8.1 8.5 AgileMessenger IM+ TOnline
Mxit	Mixt is a free instant messaging software application developed by Mxit Lifestyle in South Africa that runs on GPRS/3G mobile phones and on PCs.	

**TABLE I-1. Application List (Continued)**

NAVER LINE	Introduction site on the smart phone apps, "LINE."	
netmeeting ils protocol	Netmeeting ils is the protocol used between Netmeeting and Internet Locator Servers (ILS). Netmeeting is a VoIP and multi-point video conferencing client included in many versions of Microsoft Window. A Internet Locator Server (ILS) is a directory used to find other users and facilitate rendezvous.	11.70
OICQ	Oicq is a proprietary messaging protocol developed by Tencent, at the origin of the qq protocol.	
oovoo	oovoo is an instant messenger, with audio/video support.	Oovoo v2.8.0.39
PalTalk Protocol	Paltalk is an instant messaging protocol.	8.1 8.5 9.0 9.1 9.4
Phweet	Contains web traffic designated to the host "blog.phweet.com".	

**TABLE I-1. Application List (Continued)**

QQ	QQ is the most popular free instant messaging computer program in China.	QQ2003 QQ2005_EN V05.0.200 TM2008 Preview QQ2011
RadiusIM	Contains web traffic designated to the host "radiusim.com".	
Secure AIM	Secure AIM is the secure version of AIM.	
Skype	Skype is a widely used free voice over IP protocol.	4.0 4.1 4.2 5.0b
Teamspeak	TeamSpeak is proprietary Voice over IP protocol.	2
TeamSpeak v3	TeamSpeak 3 continues the legacy of the original TeamSpeak communication system. TeamSpeak 3 is not merely an extension of its predecessors but rather a complete rewrite in C++ of its proprietary protocol and core technology.	32bits 3.0.3 PC-clt,amd64 3.0.1 PC-srv,3.0.0-beta Android-clt
UCSina	UCSina is a Chinese chat client similar to MSN Messenger or ICQ. It contains several features like: chat, news portal, micro blogging, music player, online storage (files, photos, etc.)	Sina v1.7

**TABLE I-1. Application List (Continued)**

WhatsApp Messenger	WhatsApp Messenger is a cross-platform, instant, mobile messaging application which allows the users to exchange messages without having to pay for SMS. WhatsApp Messenger is available for iPhone, BlackBerry, Android and Nokia and yes, those phones can all message each other.	1.3
Yahoo Messenger	Yahoo Messenger is used by the Yahoo Instant Messenger application to send instant messages, files and emails between users.	>=8.1
Yahoo Messenger conference service	This protocol is used in signaling part in a conference call.	
Yahoo messenger on web	Yahoo web messenger	
Yoono	Contains web traffic designated to the hosts "api.yoono.com" and "cdn.yoono.com".	
Zoho IM	Contains web traffic designated to the host "wms.zoho.com", or associated to the SSL Common Name "wms0.zoho.com".	
<b>MIDDLEWARE</b>	<b>DESCRIPTION</b>	<b>SUPPORTED APPLICATIONS</b>

**TABLE I-1. Application List (Continued)**

Advance Mes- sage Queuing Protocol	Advanced Message Queuing Protocol	0.8 0.9
Datagram Inter-ORB Proto- col	DIOP is a GIOP implementation over UDP which aims to be more efficient than the TCP one.	
Distributed Com- puting Environ- ment Remote Procedure Call (DCERPC)	The DCERPC protocol is an RPC implementation used in Distributed Computing Environments. This protocol is used by many software applications including Microsoft Exchange.	
General Inter-ORB Proto- col (Corba) (CORBA)	The General Inter Orb protocol (GIOP) is used to make requests or return replies between ORBs in a Corba environment.	
Internet Inter-ORB Proto- col	IIOP is the GIOP implementation over TCP.	
Microsoft Remote Procedure Call	Microsoft Remote Procedure Call (MSRPC) is the Microsoft implementation of the DCE RPC mechanism.	RPC v1.2
Remote Proce- dure Call (RPC)	RPC (Remote Procedure Call) is an easy and popular paradigm for implementing the client-server model of distributed computing. A request is sent to a remote system to execute a designated procedure, using arguments supplied, and the result is returned to the caller.	

**TABLE I-1. Application List (Continued)**

RMI over IIOP	RMI-IIOP (Remote Method Invocation over Internet Inter-ORB Protocol) delivers CORBA distributed architecture to Java 2 platform, using both remote method invocation system RMI and IIOP protocol.	CORBA/IIOP 2.3.1
Secure General Inter-ORB Protocol	Secure version of the GIOP protocol.	
Simple Object Access Protocol (SOAP)	SOAP is a lightweight protocol intended for exchanging structured information in a decentralized, distributed environment. It defines, using XML technologies, an extensible messaging framework containing a message construct that can be exchanged over a variety of underlying protocols.	
<b>NETWORK MANAGEMENT</b>	<b>DESCRIPTION</b>	<b>SUPPORTED APPLICATIONS</b>
Altiris	Altiris provides service-oriented management solutions which allows to manager IT infrastructures.	Altiris Client Management Suite 7.1
Cisco Netflow Protocol	NetFlow is a Cisco protocol that provides nearly real-time traffic monitoring, aggregation and statistic evaluation, multi-criteria data flow selection, using source/destination IP addresses, protocols, etc.	



**TABLE I-1. Application List (Continued)**

Simple Network Management Protocol (SNMP)	SNMP is a request/response protocol that communicates management information between two types of SNMP software entities: SNMP applications (also called SNMP managers) and SNMP agents.	1 2c 2u 3
TD collect protocol	TD collect is a Qosmos protocol used in the collect procedure between Qwork probes and Qcenter (Qosmos).	
Zabbix agent	Agent for Zabbix monitoring server. Uses TCP port 10050.	1.8
<b>NETWORK SERVICE</b>	<b>DESCRIPTION</b>	<b>SUPPORTED APPLICATIONS</b>
CGI Proxy	CGIProxy is a proxy software package. A CGI (Common Gateway Interface) Proxy is a proxy that appears as a web page allowing the user access to all sites through it.	
Concurrent Versions System	The Concurrent Versions System keeps track of all work and all changes in a set of files, typically the implementation of a software project, and allows several developers to collaborate.	
Connection Oriented Transfer Protocol (ISO)	COTP (Connection Oriented Transport Protocol) is a protocol ensuring the transport service in the OSI model.	

**TABLE I-1. Application List (Continued)**

Domain Name Service (DNS)	The DNS protocol is used to translate internet names (www.site.com) into IP addresses and vice versa.	
Dynamic Host Configuration Protocol (DHCP)	The DHCP protocol is used to configure automatically the network parameters of a station.	
Group 3 facsimile communication over IP	This protocol is used to exchanges FAXes on top on TCP/IP.	
Multipoint Communication Service	Multipoint Communication Service (MCS) is a multipoint data delivery service for use in multimedia and audiovisual conferencing service. It provides the mechanism for multipoint aware applications to send data to all or a subset of the group with a single send primitive and to force, if desired, a uniformly sequenced reception of data for all users.	
NetBIOS Name Service	NetBIOS Name Service (NBNS) is a protocol resulting from NetBIOS and which makes it possible to manage the names in a Microsoft NetBIOS network. NetBIOS names are human readable and NBNS serves the same purpose as the DNS system in IP environments.	

**TABLE I-1. Application List (Continued)**

Netware Core Protocol	The NetWare Core Protocol (NCP) is a network protocol used to access file, print, directory, clock synchronization, messaging, remote command execution and other network service functions.	
Network Time Protocol (NTP)	Network Time Protocol (NTP) is a time synchronization system for computer clocks through the Internet network. It provides mechanisms to synchronize time and coordinate time distribution in a large network.	
PHPProxy	PHPProxy is a web HTTP proxy programmed in PHP meant to bypass firewalls and access otherwise inaccessible resources.	0.5 beta 2
Resource Location Protocol	Resource Location Protocol (RLP) is a protocol used to discover the location of resources present in a network.	
Simple Network Paging Protocol	Protocol defines a method by which a pager can receive a message over the Internet	
Simple Traversal of UDP through NATs	STUN (Simple Traversal of UDP through NATs) allows a client behind a NAT to establish UDP tunnels between two hosts.	

**TABLE I-1. Application List (Continued)**

Subversion version control system	Subversion, version control system.	2
TIBCO Rendez-Vous Protocol	This protocol is used in financial domain (banks).	
Time Protocol	This protocol provides a site-independent, machine readable date and time. The Time service sends back to the originating source the time in seconds since midnight on January first 1900.	
Whois Protocol	WHOIS is a query and response protocol that is widely used for querying databases that store the registered users or assignees of an Internet resource, such as a domain name, an IP address block, or an autonomous system, but is also used for a wider range of other information.	
Windows Live File Storage	Windows Live File Storage is a Microsoft web service designed to be used by other Microsoft web services that may need storage, for example msn, skydrive, etc.	

**TABLE I-1. Application List (Continued)**

WINS Replica- tion protocol	WINS (Windows Internet Naming Service) is Microsoft's implementation of NetBIOS Name Service (NBNS), a name server and service for NetBIOS computer names. This plug-in classifies replication flows between servers. Client-to-Server flows are handled by the nbns plug-in.	
<b>PEER-TO-PEER</b>	<b>DESCRIPTION</b>	<b>SUPPORTED APPLICATIONS</b>
AppleJuice	AppleJuice is a P2P file exchange protocol similar to E-Donkey.	
Ares Protocol	Ares is a peer to peer protocol.	Ares2.1.1 Ares2.0
Babelgum	Contains web traffic designated to the host "babelgum.com".	
BitTorrent Protocol	BitTorrent is a peer-to-peer protocol.	Azureus BitComet Deluge Ktorrent Bittorrent MLDonkey utorrent
Cabos	Site that exposes the P2P software Cabos.	

**TABLE I-1. Application List (Continued)**

Clip2Net	Contains web traffic designated to the host "clip2net.com".	
Diino	Contains web traffic associated to the SSL Common Name "diino.com".	
DirectConnect	DirectConnect is a peer to peer protocol.	
Edonkey	Edonkey is a peer to peer protocol.	emule0.48a
Filetopia	Filetopia is a free, proprietary p2p client software for Windows. It uses an encrypted protocol for all its communications. In addition to the usual p2p features, Filetopia provides a chat, a buddy search and a message board.	
FlashGet	FlashGet is a Windows based download accelerator which supports BT, eMule, eDonkey, FTP, HTTP, HTTPS, MMS and RSTP protocols.	3.7.0.1198
Foxy	Foxy is a Peer To Peer protocol based on GnucDNA.	
fring - Peer-to-Peer Mobile VOIP (Fring)	fring is a peer to peer Mobile VoIP based internet telephony network	

TABLE I-1. Application List (Continued)

GNUnet protocol	GNUnet is a framework for secure peer-to-peer networking. It is mainly used for anonymous file sharing. It is part of GNU project.	
Gnutella	Gnutella is a peer to peer protocol.	limewire>=4.16.6 Shareaza>=3.3.1 .0 imesh>=7.2.0.45 910
GoBoogy Protocol	GoBoogy is a peer to peer protocol.	
iMesh	iMesh is a peer to peer protocol.	
Joost	Contains web traffic designated to the host "video.joost.com".	
Kazaa	Kazaa is a peer to peer protocol	
Kugou/Kugoo	Kugou is a multimedia peer-to-peer application providing file sharing, chat or broadcasting services.	20110125
Live Mesh	Contains web traffic associated to the SSL Common Names "accounts.mesh.com", "storage.mesh.com" and "enclosure.mesh.com".	

**TABLE I-1. Application List (Continued)**

Manolito	Manolito is a P2P file sharing software.	Manolito v3.1.1
Mute Protocol	Mute is a peer to peer protocol.	
OpenFT Protocol	OpenFT is a peer to peer protocol.	
Pando protocol	Pando is a peer-to-peer protocol.	>=2.3.0.9
Perfect Dark	Site describes how to use P2P software Perfect Dark. Explaining how to use Perfect Dark to do file sharing.	
Profes	P2P software download site of Profes. Profes P2P software is made in Japan. . Move using the NET. Has not been updated at the end of 2009 a beta version. As P2P share is low. Brothersoft is a site that has been opened to the public free software without permission.	
QQDownload	QQDownload is a Windows based file download tool (current version: 3.9.2011.12.8) developed by Tencent ( as known as QQ). It supports eMule, BT and its own QQDownload protocol.	1.10
QQStream	QQStream is a Chinese peer-to-peer file sharing software. QQstream is a meta protocol which contains data stream of QQLive and QQMusic.	QQStream 2011



**TABLE I-1. Application List (Continued)**

Real Time Mes- saging Protocol	Real Time Messaging Protocol (RTMP) is a proprietary protocol developed by Adobe Systems for streaming audio, video and data over the Internet, between a Flash player and a server.	
share-p2p	Download site that exposes the P2P software Share. Downpanda site that has been opened to the public as a free software.	
Soribada	Contains web traffic designated to the host "kpop.soribada.com".	
SoulSeek	Soulseek is a peer to peer protocol.	>=1.56c
uTorrent Trans- port Protocol	Bittorrent transport layer.	
Vakaka	Contains web traffic designated to the host "vakaka.com".	

**TABLE I-1. Application List (Continued)**

VeryCD	VeryCD is a Chinese website that shares files via eD2k links. easyMule developed since 2007 is now the company's primary client. It removes the category, message, IRC, custom skin and some other features from eMule, adds BHO (Browser Helper Object) plug-in to users' IE browser. The browser built in easyMule can only access VeryCD.com site. easyMule's users can't search via eDonkey servers or Kad network, it is only allowed to search from the links indexed by VeryCD.com.	1.2.2 b111110
WinMX	WinMX is a peer to peer protocol.	3.53
winny	Site describes how to use P2P software Winny. Winny as public file sharing site, explanations of how to file sharing in detail.	
Xunlei/Thunder protocol	Xunlei/Thunder protocol	20090430
Zattoo	Zattoo is a P2PTV protocol.	
<b>PRINTER</b>	<b>DESCRIPTION</b>	<b>SUPPORTED APPLICATIONS</b>

**TABLE I-1. Application List (Continued)**

Common Unix Printer System (CUPS)	The Common Unix Printer System (CUPS) protocol is a cross-platform printing solution for UNIX environments. It is based on the "Internet Printing Protocol" and it is compatible with Microsoft Operating systems since Windows 2000.	
HP Printer Job Language	The Jetdirect protocol is used by HP network printers.	
Internet Printing Protocol	Internet Printing Protocol (IPP) is a standard used for distributed printing using Internet tools and technologies.	
Line Printer Daemon	LPR is a protocol providing printing services and used in Berkeley distributions of the Unix(tm) operating system.	
<b>SECURITY SERVICE</b>	<b>DESCRIPTION</b>	<b>SUPPORTED APPLICATIONS</b>
GhostSurf Protocol	GhostSurf is an internet privacy application.	6.0
<b>TERMINAL</b>	<b>DESCRIPTION</b>	<b>SUPPORTED APPLICATIONS</b>
Remote Login (RLogin)	The Rlogin protocol allows establishing a bidirectional communication to distant terminals.	

**TABLE I-1. Application List (Continued)**

Remote Shell (RSH)	The RSH protocol allows a user to establish a secure connection to a remote host and to obtain a shell allowing commands to be sent to the remote machine to be executed.	
Secure Shell (SSH)	Secure Shell (SSH), sometimes known as Secure Socket Shell, is a UNIX-based command interface and a protocol for obtaining secure access to a remote computer.	
Secure TELNET (Secure Telnet)	Secure version of the Telnet.	
Telnet	Telnet provides a fairly general, bidirectional, eight-bit byte oriented communications facility. Its primary aim is to provide a standard method of interfacing between terminal devices and terminal-oriented processes.	
Tnvip (Telnet VIP)	Telnet VIP is an emulation of the Telnet protocol for VIP (Visual Information Projection) terminals.	
<b>THIN CLIENT</b>	<b>DESCRIPTION</b>	<b>SUPPORTED APPLICATIONS</b>
Citrix GoToMyPC Remote Access	Citrix GoToMyPC is a secured web-based remote access solution, enabling taking control of a PC/MAC from a web browser.	Citrix GoToMyPC 7.0

**TABLE I-1. Application List (Continued)**

Citrix JEDI	JEDI is the name of the CITRIX streaming connection protocol.	
ClearCase	ClearCase is a source control / configuration management tool from IBM's "Rational" division	7.1.2
GotoDevice	GoToDevice is a remote control and administration tool.	Gotodevice v2.1.8087
Independent Computing Architecture (Citrix)	ICA (Independent Computing Architecture) is a protocol of communication and a property of the Citrix company.	
PCAnywhere	PCAnywhere is a remote control solution. It can manage both Windows and Linux systems. Enhanced video performance and built-in AES 256-bit encryption help make communications fast and secure. PCAnywhere also features powerful file-transfer capabilities.	
Radmin	Radmin is a control software which is able to establish a remote secure connexion between computers.	Radmin 3.4

**TABLE I-1. Application List (Continued)**

Remote Desktop Protocol (Windows Terminal Server) (RDP)	A key component of terminal server is the Remote Desktop Protocol which allows a thin client to communicate with the terminal server over the network. This protocol is based on International Telecommunications Union's (ITU) T.120 protocol, an international, standard multichannel conferencing protocol currently used in the Microsoft NetMeeting conferencing software product. It is tuned for high-bandwidth enterprise environments and will also support encrypted sessions.	4 5 6
Remote Frame Buffer (VNC)	RFB (Remote Frame Buffer) is a simple protocol for remote access to graphical user interfaces.	
ShowMyPc	Contains web traffic associated to the SSL Common Name "assured.showmypc.com".	
TeamViewer	TeamViewer is an application that enables a connection to a remote computer in order to perform maintenance operations. It is also possible to show to a remote computer the current display, to transfer files and create a VPN tunnel.	5 6
VMWare	VMWare is a protocol used by the VMWare application, allowing it to have network interfaces and remote access to a virtual machine.	

**TABLE I-1. Application List (Continued)**

X Display Manager Control Protocol	XDMCP is an extension of the X11 protocol that addresses the issue of discovering and authenticating to available X servers on the LAN.	1.1
X-Window	X11 is designed to communicate all the information necessary to operate a window system over a single asynchronous bidirectional stream of 8-bit bytes. The X protocol specifies four types of messages but named extensions can also be defined to extend the system.	
<b>TUNNELING</b>	<b>DESCRIPTION</b>	<b>SUPPORTED APPLICATIONS</b>
AnalogBit tcp-over-dns	Tcp-over-dns contains a special dns server and a special dns client. The client and server work in tandem to provide a TCP and UDP tunnel through the standard DNS protocol.	
GPRS Tunneling Protocol	The GPRS Tunneling Protocol (GTP) is used to create a tunnel between the SGSN and GGSNs of a mobile operator network, thus allowing mobile station data to be transmitted.	

**TABLE I-1. Application List (Continued)**

GPRS Tunneling Protocol version 2	The GPRS Tunneling Protocol (GTP) version 2 is used in G4 mobile networks (LTE). Its purpose is exchanging control message between the MME, the SGW et the PGW. These messages leads to the creation of an IP data tunnel between the eNodeB, the SGW and the PGW, thus allowing mobile station data to be transmitted.	
HTTP Tunnel	HTTP Tunnel protocol is used to tunnel protocols inside HTTP stream.	
Level 2 Tunneling Protocol (L2TP)	Layer Two Tunneling Protocol (L2TP) is an extension of the Point-to-Point Tunneling Protocol (PPTP) used by an Internet service provider (ISP) to enable the operation of a virtual private network (VPN) over the Internet.	
OpenVPN	OpenVPN is used for establishing a secure connection between two entities	
Point-to-Point Tunneling Protocol (PPTP)	Point-to-Point Tunneling Protocol allows the Point to Point Protocol (PPP) to be tunneled through an IP network.	
Socks2http	Socks2http is a client software aiming to make a tunnel.	1.0.2.411



**TABLE I-1. Application List (Continued)**

Teredo	The Teredo protocol enables IPv6 tunnelling over UDP, traversing NATs, and with minimum over-head.	
Ultrasurf	Ultrasurf is a tunneling protocol used by the Ultrasurf software for Windows. The classification is based on an IP address range analysis.	10.08,12.02
X25 over TCP	Protocol used to transport, over TCP, x25 data in IP network.	
<b>WAP</b>	<b>DESCRIPTION</b>	<b>SUPPORTED APPLICATIONS</b>
MMS Encapsulation	Multimedia Messages Encapsulation protocol (MMSE) is used by mobile stations to send multimedia messages.	
Short message peer-to-peer protocol	SMPP is a telecommunications industry protocol for exchanging SMS messages between SMS peer entities.	3.4 5.0
Universal Computer Protocol	Universal Computer Protocol is used by some mobile phones to send SMS.	
WAP Binary XML	The WAP Binary XML protocol defines an encoding scheme for the binary data used in WAP environments.	

**TABLE I-1. Application List (Continued)**

Wireless Session Protocol (WSP)	Wireless Session Protocol (WSP) is an application layer protocol present in the WAP stack. It is used by mobile stations to send SMS for example.	
Wireless Transaction Protocol (WTP)	Wireless Transaction Protocol (WTP) is a transport layer protocol which belongs to the WAP stack. It provides a reliable transmission of network packets and is very similar to TCP.	
Wireless Transport Layer Security (WTLS)	Wireless Transport Layer Security (WTLS) is a security protocol, part of the WAP stack. It sits between the WTP and WDP layers in the WAP communications stack.	
<b>WEBMAIL</b>	<b>DESCRIPTION</b>	<b>SUPPORTED APPLICATIONS</b>
AIRnet WebMail	Web mail service, available by ISP "AIRnet" users.	
Dynamic Internet Messaging Program	Webmail DIMP	
Facebook mail	Facebook mail is a webmail environment on Facebook.	
Gmail basic (Gmail)	Webmail Google, HTML version	

**TABLE I-1. Application List (Continued)**

Gmail mobile version	Gmail mobile is the Google webmail for mobile phones	
gmx	GMX is a German webmail.	
Google Mail (Gmail)	Google webmail	20100630
IMP mobile version	MIMP is the IMP webmail for mobile phones	
Internet Messaging Program	IMP is the IMAP webmail of the Horde project	
La Poste Webmail	La Poste webmail	20090424
LinkedIn website	LinkedIn is professional social network.	
Live hotmail for mobile	Livemail_mobile is the live mail webmail for mobile phones	
mail.ru webmail	mailru is the mail.ru webmail	
Maktoob mail	Maktoob webmail	
ODN WebMail	Web mail service, available by ISP "ODN" users.	

**TABLE I-1. Application List (Continued)**

Orange webmail	Orange mail is the webmail on web-mail.orange.fr	
Outlook Web Access	Outlook Web Access	
PostPet WebMail	Web mail service, available by ISP "so-net" users.	
Rambler webmail	Rambler webmail is the webmail on russian website rambler.ru	
Shibata Network Service	Web mail service, available by ISP "Niigata communication service" users.	
So-net WebMail	Web mail service, available by ISP "so-net" users.	
SquirrelMail	SquirrelMail is a web-based email application written in the PHP scripting language.	
Windows Live Hotmail	Windows Live Hotmail	20100630
Yahoo Mail Ajax version (Yahoo Mail)	Yahoo webmail, AJAX version.	20100630
Yahoo Mail classic (Yahoo Mail)	Yahoo webmail, classic version.	20100630

**TABLE I-1. Application List (Continued)**

Yahoo webmail for mobile	Ymail_mobile is the webmail on yahoo.com adapted to mobiles	
Yahoo webmail for mobile (New version)	Ymail_mobile_new is the new webmail on yahoo.com adapted to mobiles	
Yandex webmail	Yandex webmail is the Russian webmail on webmail.yandex.ru	
Zimbra	Zimbra webmail.	200905112
Zimbra Webmail Standard Version	zimbra_standard is the called standard version for the zimbra webmail	
<b>WEBSITE</b>	<b>DESCRIPTION</b>	<b>SUPPORTED APPLICATIONS</b>
01net	Contains web traffic designated to the host "01net.com".	
0zz0	0zz0 is an online solution to store, send and share files.	
10086cn	Contains web traffic designated to the host "10086.cn".	
114la	Contains web traffic designated to the host "114la.com".	

**TABLE I-1. Application List (Continued)**

115com	Contains web traffic designated to the host "115.com".	
118114cn	Contains web traffic designated to the host "118114.cn".	
11st	This protocol contains web traffic to the host "11st.co.kr".	
123people	Contains web traffic designated to the host "123people.com".	
163.com	This protocol contains web traffic to the host "163.com".	
2ch	Largest anonymity bulletin board site in Japan. A collection of bulletin board, such as hobbies, religion, political, economic, of all genres. Because it is anonymous user, there are many illegal write.	
2Shared	2shared is an online space for sharing and storage.	
360buy	This protocol contains web traffic to the host "360buy.com".	
360cn	This protocol contains web traffic to the host "360.cn".	

**TABLE I-1. Application List (Continued)**

4399com	This protocol contains web traffic to the host "4399.com".	
4Shared	4shared is an online space for sharing and storage.	
51job	This protocol contains web traffic to the host "51job.com".	
51la	This protocol contains web traffic to the host "51.la".	
56com	This protocol contains web traffic to the host "56.com".	
58com	This protocol contains web traffic to the host "58.com".	
abcnews	Contains web traffic designated to the host "abcnews.com".	
about	Contains web traffic designated to the host "about.com".	
accuweather	Contains web traffic designated to the host "accuweather.com".	
acer	Contains web traffic designated to the host "acer.com".	

**TABLE I-1. Application List (Continued)**

acrobat	Contains web traffic designated to the host "www.acrobat.com".	
addictinggames	Contains web traffic designated to the host "addictinggames.com".	
ADNStream	Contains web traffic associated to the SSL Common Name "adnstream.tv".	
Adobe Flash-Plugin Update	Flash exchanges plug-in version numbers with Adobe servers.	
Adobe Meeting Remote Control	Contains web traffic designated to the hosts "connectpro97286496.emea.acrobat.com", "connectpro97286496.adobeconnect.com" and "www.emea.acrobat.com", or associated to the SSL Common Name "emea.acrobat.com".	
Adobe Update Manager	Adobe Update Manager is a program which maintains up-to-date versions of some Adobe software.	adobe-updatemanager5 adobe-updatemanager6
Adrive	Contains web traffic designated to the host "adrive.com", or associated to the SSL Common Name "adrive.com".	
adultadworld	Contains web traffic designated to the host "adultadworld.com".	



**TABLE I-1. Application List (Continued)**

adultfriendfinder	Contains web traffic designated to the host "adultfriendfinder.com".	
Advogato	Contains web traffic from "www.advogato.org".	
agame	Contains web traffic designated to the host "agame.com".	
aiaigame	Contains web traffic designated to the host "aiaigame.com".	
Aizhan	This protocol contains web traffic to the host "aizhan.com".	
alexa	Contains web traffic designated to the host "alexa.com".	
Alibaba	This protocol contains web traffic to the host "alibaba.com".	
Alimama	This protocol contains web traffic to the host "alimama.com".	
Alipay	This protocol contains web traffic to the host "alipay.com", or associated to the SSL Common Name "alipay.com".	
aljazeera	Contains web traffic designated to the host "aljazeera.net".	

**TABLE I-1. Application List (Continued)**

allocine	Contains web traffic designated to the host "allocine.fr".	
amazon	Contains web traffic designated to the hosts "amazon.cn", "amazon.co.jp", "amazon.co.uk", "amazon.com", "amazon.de" and "amazon.fr".	
Amazon MP3	Amazon MP3 is an online music store owned and operated by Amazon.com.	
Amazon Video	Amazon Video is an online video on demand service owned and operated by Amazon.com.	
Amazon Web Services	This protocol contains web traffic to the host "amazonaws.com", or associated to the SSL Common Name "amazonaws.com".	
Ameba		
Ameba Blog	Major Japanese blog site. Also has a function of the SNS site. Interaction among the users can manipulate the avatar called "Vig". Operated by CyberAgent.	
Ameba Now	Site describes how to use the P2P software to share files in detail.	
Ameba Pigg	pigg.ameba.jp/	

**TABLE I-1. Application List (Continued)**

americanexpress	Contains web traffic designated to the host "americanexpress.com".	
Amie street	Contains web traffic from "amies-treet.com".	
aNobii	Contains web traffic from "www.ano-bii.com".	
answers	Contains web traffic designated to the host "answers.com".	
Apple	Contains web traffic from "www.apple.com".	
Apple Airport	Apple Airport protocol aiming to configure a wireless device.	
Apple Update	Apple_update is the protocol used for apple software updates.	
Archive	Archive.org is building a digital library of Internet sites and other cultural artifacts in digital form. Like a paper library, they provide free access to researchers, historians, scholars, and the general public.	
armorgames	Contains web traffic designated to the host "armorgames.com".	

**TABLE I-1. Application List (Continued)**

Asiae	This protocol contains web traffic to the host "asiae.co.kr".	
Ask	Contains web traffic from "www.ask.com" and "fr.ask.com".	
ASmallWorld	Contains web traffic from "www.asmallworld.net".	
Athlinks	Contains web traffic from "www.athlinks.com".	
att	Contains web traffic designated to the host "att.com".	
Auction	This protocol contains web traffic to the host "www.auction.co.kr".	
aufeminin	Contains web traffic designated to the host "aufeminin.com".	
Avatars united	Contains web traffic from "www.avatarsunited.com".	
Avg Update	Avg_update is the protocol used for avg software updates.	
Avira Update	Avira_update is the protocol used for avira software updates.	

**TABLE I-1. Application List (Continued)**

Avoidr	Contains web traffic from "www.avoidr.com".	
Babycenter	Contains web traffic from "www.baby-center.com".	
badongo	badongo is an online solution to store, send and share files.	
Badoo	Contains web traffic from "www.badoo.com".	
Baidu	Baidu is a Chinese search engine for websites, audio files and images. Baidu means "One hundred degrees" in English.	
Bca.co	This protocol contains web traffic to the host "bca.co.id".	
Bebo	Bebo is a social networking website, enabling users to connect to relatives, friends, or unknown people.	
Berniaga	This protocol contains web traffic to the host "berniaga.com".	
Bigadda	Contains web traffic from "www.big-adda.com".	

**TABLE I-1. Application List (Continued)**

BigTent	Contains web traffic from "www.big-tent.com".	
Bigupload	Contains web traffic designated to the host "bigupload.com", or associated to the SSL Common Name "www3.bigupload.com".	
Biip	Contains web traffic from "www.biip.no".	
Bing	This protocol is used for sending user queries to the Bing search engine.	
BitDefender Update	BitDefender_update is the protocol used for BitDefender software updates.	
BlackBerry	Blackberry.	
BlackPlanet	Contains web traffic from "www.black-planet.com".	
Blogdetik	This protocol contains web traffic to the host "Blogdetik.com".	
blogger	Contains web traffic designated to the host "blogger.com".	
blogspot	Contains web traffic designated to the host "blogspot.com".	

**TABLE I-1. Application List (Continued)**

Blogster	Contains web traffic from "www.blogster.com".	
Blokus	Contains web traffic designated to the host "blokus.fr".	
Bloomberg	Bloomberg is a website about business and financial news.	
bluejayfilms	Contains web traffic designated to the host "bluejayfilms.webs.com".	
Bolt	Contains web traffic from "www.bolt.com".	
Bonpoo	Contains web traffic designated to the host "bonpoo.com".	
Books iRead	Contains web traffic from "weread.com".	
Box.net	Contains web traffic designated to the host "box.net", or associated to the SSL Common Name "box.net".	
Brighttalk	Contains web traffic designated to the host "brighttalk.com".	
BuddyBuddy	This protocol contains web traffic to the host "buddybuddy.co.kr".	

**TABLE I-1. Application List (Continued)**

Bugs	This protocol contains web traffic to the host "bugs.co.kr".	
businessweek	Contains web traffic designated to the host "businessweek.com".	
Buzznet	Contains web traffic from "www.buzznet.com".	
Bypassthat	Contains web traffic from "www.bypassthat.com".	
Cafemom	Contains web traffic from "www.cafe-mom.com".	
cam4	Contains web traffic designated to the host "cam4.com".	
Campfire	Contains web traffic associated to the SSL Common Name "campfire-now.com".	
camzap	Contains web traffic designated to the host "camzap.com".	
capitalone	Contains web traffic designated to the host "capitalone.com".	
Care2	Contains web traffic from "www.care2.com".	



**TABLE I-1. Application List (Continued)**

cartoonnetwork	Contains web traffic designated to the host "cartoonnetwork.com".	
cdiscount	Contains web traffic designated to the host "cdiscount.com".	
Cellufun	Contains web traffic from "m.cellu-fun.com".	
Channel4	Contains web traffic designated to the host "channel4.com".	
china.com	Contains web traffic designated to the host "china.com".	
china.com.cn	Contains web traffic designated to the host "china.com.cn".	
Chinaz	This protocol contains web traffic to the host "chinaz.com".	
Chosun	This protocol contains web traffic to the host "chosun.com".	
Chosun Daily	This protocol contains web traffic to the host "www.chosun.com".	
Chrome Update	Chrome Update is the protocol for the update for the google chrome browser.	

**TABLE I-1. Application List (Continued)**

CJ mall	This protocol contains web traffic to the host "cjmall.com".	
Classmates	Contains web traffic from "www.classmates.com".	
Cloob	Contains web traffic from "www.cloob.com".	
clubic	Contains web traffic designated to the host "clubic.com".	
cnet	Contains web traffic designated to the host "cnet.com".	
cnn	Contains web traffic designated to the hosts "cnn.co.uk" and "cnn.com".	
cntv	Contains web traffic designated to the hosts "cntv.cn" and "cctv.com".	
Cnzz	This protocol contains web traffic to the hosts "cnzz.com" and "cnzz.net".	
College Blender	Contains web traffic from "www.collegeblender.com".	
comcast	Contains web traffic designated to the hosts "comcast.com" and "comcast.net".	

**TABLE I-1. Application List (Continued)**

Concur	Contains web traffic designated to the hosts "concur.com" and "concur-solutions.com", or associated to the SSL Common Names "concur-solutions.com" and ".concur.com".	
CoralCDN user	Contains web traffic designated to the host "nyud.net".	
Couch surfing	Contains web traffic from "www.couchsurfing.org".	
Coupang	This protocol contains web traffic to the host "coupang.com".	
Csdn	This protocol contains web traffic to the host "csdn.net".	
Daily booth	Contains web traffic from "daily-booth.com".	
Daily strength	Contains web traffic from "www.dailystrength.org".	
dailymail	Contains web traffic designated to the host "dailymail.co.uk".	
Dailymotion	Dailymotion is a website where users can send or watch videos.	

**TABLE I-1. Application List (Continued)**

Data Bin	<p>http://www.datadeliver.net/ free file sharing service. You can choose from three type of plans. "non registered free plan", "registered free plan" and "registered fee-charging plan".too. They are listed higher place at Google search.</p>	
daum	<p>Contains web traffic designated to the host "daum.net".</p>	
davidov	<p>Contains web traffic designated to the host "davidov.do.am".</p>	
Debian/Ubuntu Update	<p>Update protocol of APT, the Debian/Ubuntu packet manager.</p>	
Decayenne	<p>Contains web traffic from "www.decayenne.com".</p>	
Deezer	<p>Contains web traffic from "www.deezer.com".</p>	
Delicious Update	<p>Delicious (formerly del.icio.us, pronounced "delicious") is a social book marking web service for storing, sharing, and discovering web bookmarks.</p>	
DepositFiles	<p>Contains web traffic designated to the host "depositfiles.com".</p>	

**TABLE I-1. Application List (Continued)**

Detik	This protocol contains web traffic to the host "Detik.com".	
Detiknews	This protocol contains web traffic to the hosts "Detiknews.com" and "news.detik.com".	
Deviant Art	Contains web traffic from "www.deviantart.com".	
digg	Contains web traffic designated to the host "digg.com".	
DigitalVerse	Contains web traffic from "www.digitalverse.org".	

**TABLE I-1. Application List (Continued)**

DirectDownload Links	Contains web traffic designated to the hosts "data.hu", "filearchiv.ru", "filepost.ru", "ifolder.ru", "filehost.tv", "sharebase.to", "load.to", "uploaded.to", "leteckaposta.cz", "yourfiles.biz", "yourfiles.to", "rapidshare.de", "ultrashare.de", "uploady-ourfiles.de", "speedshare.org", "files-upload.com", "rapidupload.com", "turboupload.com", "fileho.com", "bestsharing.com", "quicksharing.com", "sharebig.com", "chinamofile.com", "hotfile.com", "savefile.com", "sendmefile.com", "sharebigfile.com", "up-file.com", "easy-share.com", "fast-share.com", "live-share.com", "ftp2share.com", "gigeshare.com", "megashare.com", "gigasize.com", "sharebee.com", "megashares.com", "fileup-ours.com", "filefactory.com", "filefront.com", "uploadingit.com", "uploadpower.com", "file-upload.net", "simpleupload.net", "wiiupload.net", "filesend.net", "filer.net", "livedepot.net" and "odsiebie.najlepsze.net".	
directv	Contains web traffic designated to the host "directv.com".	
Disaboom	Contains web traffic from "www.disaboom.com".	

**TABLE I-1. Application List (Continued)**

DivShare	Contains web traffic designated to the host "divshare.com", or associated to the SSL Common Name "divshare.com".	
Dnshop	This protocol contains web traffic to the host "dnshop.com".	
Docstoc	Contains web traffic designated to the hosts "docstoccdn.com" and "docstoc.com".	
Dol2day	Contains web traffic from "www.dol2day.com".	
Donga	This protocol contains web traffic to the host "donga.com".	
DontStayIn	Contains web traffic from "www.dontstayin.com".	
Douban	This protocol contains web traffic to the host "douban.com".	
Doubleclick ads	Doubleclick Ads	
Draugiem	Contains web traffic from "www.draugiem.lv".	
Dreamwiz	This protocol contains web traffic to the host "dreamwiz.com".	

**TABLE I-1. Application List (Continued)**

Dropbox	Contains web traffic designated to the host "dropbox.com", or associated to the SSL Common Name "drop-box.com".	
drupal	Contains web traffic designated to the host "drupal.org".	
Dynamic Intranet	Contains web traffic designated to the host "dynamicintranet.com", or associated to the SSL Common Name "dynamicintranet.com".	
EarthCam	Contains web traffic designated to the host "earthcam.com".	
Ebay	Ebay is the most famous online auction and shopping website.	
eBuddy	eBuddy is a web and mobile messenger which supports various instant messaging.	
Elftown	Contains web traffic from "www.elftown.com".	
Emaps	This protocol contains web traffic to the host "empas.com".	
Eons	Contains web traffic from "www.eons.com".	



**TABLE I-1. Application List (Continued)**

Epernicus	Contains web traffic from "www.epernicus.com".	
eRoom.net	Contains web traffic associated to the SSL Common Name "project1.erom.net".	
ESET NOD32 Antivirus Updates	Virus definitions and engine updates for the ESET NOD32 anti-virus.	
eSnips	Contains web traffic designated to the host "esnips.com".	
Evony	Contains web traffic designated to the host "evony.com".	
Expedia	Contains web traffic from "www.expedia.com" and "www.expedia.fr".	
Experience Project	Contains web traffic from "www.experienceproject.com".	
Exploroo	Contains web traffic from "www.exploroo.com".	
Eyejot	Contains web traffic designated to the hosts "eyejot.com", "eyejot.typepad.com" and "eyejot.uservoice.com".	
Facebook	Facebook is a social network.	

**TABLE I-1. Application List (Continued)**

Faceparty	Contains web traffic from "www.faceparty.com".	
Faces	Contains web traffic from "www.faces.com".	
FC2 Blog	blog site. Operated by FC2 Inc. In Las Vegas.	
Fetlife	Contains web traffic from "fetlife.com".	
File Dropper	Contains web traffic designated to the host "filedropper.com".	
File Host	Contains web traffic designated to the host "filehost.ro".	
Fileflyer	FileFlyer is an online solution to store, send and share files	
FilePost	<a href="http://file-post.net/">http://file-post.net/</a> free file sharing service. You don't need to register. There is only a free plan.	
Filer.cx	Contains web traffic designated to the host "filer.cx".	
Files.to	Contains web traffic designated to the host "files.to".	

**TABLE I-1. Application List (Continued)**

Filetube	Contains web traffic designated to the host "filetube.com".	
FileTruck	<a href="http://filetruck.jp/">http://filetruck.jp/</a> free file sharing service. You have to make an account. There is only a "registered free plan."	
Fillos de Galicia	Contains web traffic from "fillos.org".	
FilmAffinity	Contains web traffic from "www.filmaffinity.com".	
firefox_update	Mozilla Firefox update protocol.	
FledgeWing	Contains web traffic from "www.fledgewing.com".	
Flickr	Contains web traffic from "www.flickr.com".	
Flixster	Contains web traffic from "www.flixster.com".	
Flumotion	Contains web traffic designated to the host "flumotion.com".	
Fluxiom	Contains web traffic designated to the host "fluxiom.com", or associated to the SSL Common Name "fluxiom.com".	

**TABLE I-1. Application List (Continued)**

Fly Proxy	Contains web traffic designated to the host "flyproxy.com", or associated to the SSL Common Name "fly-proxy.com".	
Fogbugz	Contains web traffic designated to the host "fogbugz.com", or associated to the SSL Common Name "fog-bugz.com".	
Fotki	Contains web traffic designated to the host "fotki.com".	
Fotolog	Contains web traffic from "www.fotolog.com".	
Foursquare	Contains web traffic from "four-square.com".	
foxmovies	Contains web traffic designated to the host "foxmovies.jp".	
foxnews	Contains web traffic designated to the host "foxnews.com".	
foxsports	Contains web traffic designated to the host "foxsports.com".	
FreeBSD Updates	FreeBSD updates	

**TABLE I-1. Application List (Continued)**

FreeeTV	Contains web traffic designated to the hosts "freeetv.com" and "livestream.com".	
Friends Reunited	Contains web traffic from "www.friendsreunited.com".	
Friendster	Friendster is a social networking website, enabling users to connect to relatives, friends, or unknown people.	
Fruhstuckstreff	Contains web traffic from "www.fruehstueckstreff.de".	
Fsecure Update	Fsecure_update is the protocol used for fsecure software updates.	
Fubar	Contains web traffic from "www.fubar.com".	
Funshion video player	Funshion player is a Chinese service for downloading and streaming movies.	2.4.5.9
FunWebProducts	This is a base protocol of FunWeb-Product protocol family, including MyWebSearch and Smiley Central.	
GaiaOnline	Contains web traffic from "www.gaia-online.com".	

**TABLE I-1. Application List (Continued)**

GamerDNA	Contains web traffic from "www.gamerdna.com".	
Games.co	This protocol contains web traffic to the host "games.co.id".	
Ganji	This protocol contains web traffic to the host "ganji.com".	
Gather	Contains web traffic from "www.gather.com".	
Gays	Contains web traffic from "gays.com".	
Geni	Contains web traffic from "www.geni.com".	
Gigaup	Contains web traffic associated to the SSL Common Name "gigaup.fr".	
Glide	Contains web traffic designated to the host "desktop.glidesociety.com", or associated to the SSL Common Name "glidesociety.com".	
Gmarket	This protocol contains web traffic to the host "gmarket.co.kr".	
Gogoyoko	Contains web traffic from "www.gogoyoko.com".	

**TABLE I-1. Application List (Continued)**

Goodreads	Contains web traffic from "www.goodreads.com".	
Google	This protocol is used for sending user queries to the famous Google search engine.	
Google ads	Google Ads	
Google Analytics	Google Analytics is the enterprise-class web analytic solution that gives you rich insights into your website traffic and marketing effectiveness.	
Google App Engine	Google App Engine is a platform as a service (PaaS) cloud computing platform for developing and hosting web applications in Google-managed data centers.	
Google Cache	Google Cache saves a copy of the web pages that were found by the Google search engine.	
Google Desktop	Google Desktop is a desktop search software made by Google, with indexed document metadata.	
Google Earth	Google Earth is a program used to view the virtual globe.	

**TABLE I-1. Application List (Continued)**

Google Generic	This protocol is a generic layer which used as a base for all of the Google protocols.	
Google GStatic	GStatic is a download server providing static resources (like css or scripts) for Google web applications.	
Google Maps	Google Maps can be used to calculate routes or to look at maps.	
Google Picasa	Google Picasa, tool used to edit and synchronize over the web pictures.	
Google Plus	Google Plus is a social network.	
Google Skymap	Google Sky Map is an outer space viewer Android mobile application.	
Google Toolbar	The Google Toolbar is an extension for Internet Explorer and Mozilla Firefox which provides a search box, a pop-up blocker, a translator, etc..	
Google Translate	Google Translate is the traduction tool of Google.	
Gougou Search engine	Gougou is a Chinese web search engine.	



**TABLE I-1. Application List (Continued)**

Gratisindo	This protocol contains web traffic to the host "gratisindo.co.id".	
Grono	Contains web traffic from "grono.net".	
groupon	Contains web traffic designated to the hosts "groupon.com", "groupon.com.br", "groupon.fr" and "groupon.jp".	
Groupwise	Novell Groupwise is a groupware, instant-messaging and mail-application.	
Gsshop	This protocol contains web traffic to the host "gsshop.com".	
Gudanglagu	This protocol contains web traffic to the host "Gudanglagu.com".	
Gyao!	Contains web traffic designated to the host "gyao.yahoo.co.jp".	
Habbo	Contains web traffic from "www.habbo.fr" and "www.habbo.com".	
Hangame	Contains web traffic designated to the host "hangame.com".	

**TABLE I-1. Application List (Continued)**

Hankooki	This protocol contains web traffic to the host "hankooki.com".	
Hankyung	This protocol contains web traffic to the host "hankyung.com".	
Hao123	This protocol contains web traffic to the host "hao123.com".	
hardsextube	Contains web traffic designated to the host "hardsextube.com".	
Heraldm	This protocol contains web traffic to the host "heraldm.com".	
hgtv	Contains web traffic designated to the host "hgtv.com".	
Hi5	hi5 is a social networking website, enabling users to connect to relatives, friends, or unknown people.	
Hospitality Club	Contains web traffic from "www.hospitalityclub.org".	
howstuffworks	Contains web traffic designated to the host "howstuffworks.com".	
Hudong	This protocol contains web traffic to the host "hudong.com".	

**TABLE I-1. Application List (Continued)**

Hyper Text Transfer Protocol (HTTP)	The Hypertext Transfer Protocol (HTTP) is used for browsing the web.	1.0 1.1
Hyves	Contains web traffic from "www.hyves.nl".	
ibibo	Contains web traffic from "www.ibibo.com".	
ICAP	The Internet Content Adaptation Protocol (ICAP) is a lightweight HTTP-like protocol which is used to extend transparent proxy servers, thereby freeing up resources and standardizing the way in which new features are implemented. ICAP is generally used to implement virus scanning and content filters (including censorware) in transparent HTTP proxy caches.	1.0
lfeng	This protocol contains web traffic to the host "ifeng.com".	
ifile.it	Contains web traffic designated to the host "ifile.it".	
iHeartRadio	Contains web traffic designated to the host "iheartradio.com".	
ikea	Contains web traffic designated to the host "ikea.com".	

**TABLE I-1. Application List (Continued)**

Imeem	Contains web traffic from "www.imeem.com".	
Indaba Music	Contains web traffic from "www.indabamusic.com".	
Indonetwork	This protocol contains web traffic to the host "Indonetwork.co.id".	
Indowebster	This protocol contains web traffic to the host "Indowebster.com".	
Inilah.com	This protocol contains web traffic to the host "Inilah.com".	
Instagram	This protocol contains web traffic to the hosts "instagr.am" and "instagram.com", or associated to the SSL Common Name "instagram.com".	
InterNations	Contains web traffic from "www.internations.org".	
InterPark	This protocol contains web traffic to the host "www.interpark.com".	
intuit	Contains web traffic designated to the host "intuit.com".	
iqiyi	This protocol contains web traffic to the host "iqiyi.com".	

**TABLE I-1. Application List (Continued)**

IRC Galleria	Contains web traffic from "irc-galleria.net".	
Italki	Contains web traffic from "www.italki.com".	
Itsmys	Contains web traffic from "mobile.itsmy.com".	
Iwiw	Contains web traffic from "iwiw.hu".	
Jaiku	Contains web traffic from "www.jaiku.com".	
JammerDirect	Contains web traffic from "www.jammerdirect.com".	
Jango	Contains web traffic designated to the host "jango.com".	
Java Update	Java Update is the protocol for the update of the java virtual machines, also called JVM.	
Jira	Contains web traffic designated to the host "onjira.com", or associated to the SSL Common Name "onjira.com".	
Jne.co	This protocol contains web traffic to the host "jne.co.id".	

**TABLE I-1. Application List (Continued)**

jnet	Corporate site Internet advertising, video production company, of Neopurasu.	
Jobstreet	This protocol contains web traffic to the host "jobstreet.co.id".	
Joongang Daily	This protocol contains web traffic to the host "www.joins.com".	
Jubii	Contains web traffic designated to the host "jubii.dk".	
Justin.tv	Contains web traffic designated to the host "justin.tv", or associated to the SSL Common Name "*.justin.tv".	
Kaioo	Contains web traffic from "kaioo.com".	
Kapanlagi	This protocol contains web traffic to the host "Kapanlagi.com".	
karosgame	Contains web traffic designated to the host "karosgame.ru".	
Kaskus	This protocol contains web traffic to the hosts "Kaskus.us" and "selapa.com".	

**TABLE I-1. Application List (Continued)**

kaspersky	Contains web traffic designated to the host "kaspersky.com".	
Kaspersky Update	Kaspersky_update is the protocol used for kaspersky software updates.	
KB Bank	This protocol contains web traffic to the host "www.kbstar.com".	
KBS	This protocol contains web traffic to the host "www.kbs.co.kr".	
Kbstar	This protocol contains web traffic to the host "kbstar.com".	
keezmovies	Contains web traffic designated to the host "keezmovies.com".	
Kemenkumham	This protocol contains web traffic to the host "kemenkumham.go.id".	
Khan	This protocol contains web traffic to the host "khan.co.kr".	
Kino	Contains web traffic designated to the host "kino.to".	
Kiwibox	Contains web traffic from "www.kiwibox.com".	

**TABLE I-1. Application List (Continued)**

KlikBCA	This protocol contains web traffic to the host "KlikBCA.com".	
Kompas	This protocol contains web traffic to the host "Kompas.com".	
Kompasiana	This protocol contains web traffic to the host "Kompasiana.com".	
Kproxy	Contains web traffic from "www.kproxy.com".	
Ku6	This protocol contains web traffic to the host "ku6.com".	
laredoute	Contains web traffic designated to the host "laredoute.fr".	
Lastfm	Contains web traffic from "www.last.fm".	
Leapfile	Contains web traffic designated to the host "secure.leapfile.com", or associated to the SSL Common Name "secure.leapfile.com".	
leboncoin	Contains web traffic designated to the host "leboncoin.fr".	
letv	Contains web traffic designated to the host "letv.com".	



**TABLE I-1. Application List (Continued)**

LG eshop	This protocol contains web traffic to the host "lgeshop.com".	
Libero Video	Contains web traffic designated to the hosts "libero.it" and "video.libero.it".	
LibraryThing	Contains web traffic from "www.librarything.com".	
Lifeknot	Contains web traffic from "www.lifeknot.com".	
LintasBerita	This protocol contains web traffic to the host "LintasBerita.com".	
Lionair	This protocol contains web traffic to the host "lionair.co.id".	
Listografy	Contains web traffic from "listography.com".	
Live	Contains web traffic from "www.live.com".	
Live Meeting	LiveMeeting	
livedoor	Contains web traffic designated to the hosts "livedoor.com" and "livedoor.jp".	

**TABLE I-1. Application List (Continued)**

liveinternet	Contains web traffic designated to the host "liveinternet.ru".	
LiveJournal	Contains web traffic from "www.livejournal.com".	
Livemocha	Contains web traffic from "www.livemocha.com".	
LivingSocial	This protocol contains web traffic to the host "livingSocial.co.id".	
Lotte	This protocol contains web traffic to the host "lotte.com".	
Lunarstorm	Contains web traffic from "www.lunarstorm.se".	
Mandriva Update	This protocol manages the mandriva update operations. It lets identify package name, package version, package architecture and distribution, thanks to - HTTP User Agent, which must be the Aria2 download manager - HTTP Uri which must be finished with rpm extension - HTTP method, which must be a GET request.	
Mapquest	Contains web traffic from "www.mapquest.com" and "www.mapquest.fr".	

**TABLE I-1. Application List (Continued)**

mashable	Contains web traffic designated to the host "mashable.com".	
mashare	mashare is an online solution to store, send and share files.	
match	Contains web traffic designated to the host "match.com".	
MBC	This protocol contains web traffic to the host "www.imbc.com".	
Mbn	This protocol contains web traffic to the host "mbn.co.kr".	
MediaFire	Contains web traffic designated to the hosts "a.1521.x.akamai.net" and "mediafire.com", or associated to the SSL Common Name "mediafire.com".	
MEETin	Contains web traffic from "www.meetin.org".	
Meettheboss	Contains web traffic from "www.meettheboss.tv".	
Meetup	Contains web traffic from "www.meetup.com".	

**TABLE I-1. Application List (Continued)**

MeeVee	Contains web traffic designated to the host "ip-204-145-65-216.static.atlanticmetro.net".	
Megaproxy	Contains web traffic from "www.mega-proxy.fr".	
Megaupload	Megaupload is an online solution to store, send and share files	
Megavideo	Contains web traffic designated to the host "megavideo.com".	
Microsoft SharePoint	SharePoint is a web application platform designed as a centralized replacement for multiple web applications, like content management and document management systems.	SharePoint 2010
Microsoft SharePoint Administration Application	SharePoint is a web application platform designed as a centralized replacement for multiple web applications, like content management and document management systems. This plug-in classifies the administration back-end of SharePoint.	SharePoint 2010
Microsoft SharePoint Blog Management Application	SharePoint is a web application platform designed as a centralized replacement for multiple web applications, like content management and document management systems. This plug-in classifies the blog management module of SharePoint.	SharePoint 2010

**TABLE I-1. Application List (Continued)**

Microsoft SharePoint Calendar Management Application	SharePoint is a web application platform designed as a centralized replacement for multiple web applications, like content management and document management systems. This plug-in classifies the calendar management module of SharePoint.	SharePoint 2010
Microsoft SharePoint Document Management Application	SharePoint is a web application platform designed as a centralized replacement for multiple web applications, like content management and document management systems. This plug-in classifies the document management module of SharePoint.	SharePoint 2010
Mixi	Contains web traffic from "mixi.jp".	
Mk	This protocol contains web traffic to the host "mk.co.kr".	
Mobile Me	Contains web traffic associated to the SSL Common Name "auth.me.com".	
MocoSpace	Contains web traffic from "www.mocospace.com".	
MOG	Contains web traffic from "mog.com".	

**TABLE I-1. Application List (Continued)**

Mogulus	Contains web traffic designated to the hosts "a749.g.akamai.net" and ".livestream.com", or associated to the SSL Common Name "secure.livestream.com".	
monster	Contains web traffic designated to the host "monster.com".	
Mop	This protocol contains web traffic to the host "mop.com".	
MouthShut	Contains web traffic from "www.mouthshut.com".	
mozilla	Contains web traffic designated to the hosts "mozilla.com" and "mozilla.org".	
MSN search	This protocol is used for sending user queries to the MSN Live search engine.	
Mt	This protocol contains web traffic to the host "mt.co.kr".	
mtv	Contains web traffic designated to the host "mtv.com".	
Multiply	Contains web traffic from "multiply.com".	

**TABLE I-1. Application List (Continued)**

multiupload	Contains web traffic designated to the host "multiupload.com".	
musica	Contains web traffic designated to the host "musica.com".	
Muxlim	Contains web traffic from "muxlim.com".	
My Opera	Contains web traffic from "my.opera.com".	
MyAnimeList	Contains web traffic from "myanimelist.net".	
MyChurch	Contains web traffic from "www.mychurch.org".	
MyHeritage	Contains web traffic from "www.myheritage.fr".	
MyLife	Contains web traffic from "www.mylife.com".	
MySpace	MySpace is one of most popular social networking sites on the Web.	
Myspace Video	Contains web traffic designated to the host "videos.myspacecdn.com".	

**TABLE I-1. Application List (Continued)**

myvideo	Contains web traffic designated to the host "myvideo.de".	
MyWebSearch	MyWebSearch is one major service provided by Smiley Central tool bar. Contains web traffic designated to the host "mywebsearch.com".	
my_yahoo	my yahoo host traffic.	
MyYearBook	Contains web traffic from "www.myearbook.com".	
Napster	Contains web traffic designated to the hosts "napster.com", "napsterinc.tt.omtrdc.net", "a1082.b.akamai.net" and "a1702.b.akamai.net", or associated to the SSL Common Name "sms.napster.com".	
nasa	Contains web traffic designated to the host "nasa.gov".	
Nasza Klasa	Contains web traffic from "nasza-klasa.pl".	
NateCyworld	This protocol contains web traffic to the hosts "nate.com" and "cyworld.com".	
nationalgeographic	Contains web traffic designated to the host "nationalgeographic.com".	



**TABLE I-1. Application List (Continued)**

national-lottery	Contains web traffic designated to the host "national-lottery.co.uk".	
NAVER	Contains web traffic designated to the hosts "naver.com" and "naver.jp".	
nba	Contains web traffic designated to the host "nba.com".	
NetBSD Updates	NetBSD updates	
Netload	Contains web traffic designated to the host "netload.in".	
Netlog	Netlog is a social networking website, enabling users to connect to relatives, friends, or unknown people.	
NetMarble	This protocol contains web traffic to the host "netmarble.com".	
Nettby	Contains web traffic from "www.nettby.no".	
Nexian	This protocol contains web traffic to the hosts "nexian.co.id" and "nexian.us.to".	
Nexon	This protocol contains web traffic to the host "www.nexon.com".	

**TABLE I-1. Application List (Continued)**

Nexopia	Contains web traffic from "www.nexopia.com".	
nfl	Contains web traffic designated to the host "nfl.com".	
NGO Post	Contains web traffic from "ngopost.org".	
Niconico	This is a base protocol of Niconico protocol family.	
NicoNico Douga	Contains web traffic designated to the hosts "nicovideo.jp", "nicoseiga.jp" and "nicovideo.com".	
nike	Contains web traffic designated to the host "nike.com".	
Ning	Contains web traffic from "www.ning.com".	
Nokia_Ovi	Nokia_Oviy is a protocol used to stream audio files over HTTP.	
Nonghyup Bank	This protocol contains web traffic to the host "nohyup.com".	
ntv	Contains web traffic designated to the host "ntv.co.jp".	

**TABLE I-1. Application List (Continued)**

nydailynews	Contains web traffic designated to the host "nydailynews.com".	
nytimes	Contains web traffic designated to the host "nytimes.com".	
Octopz	Contains web traffic designated to the host "octopz.net", or associated to the SSL Common Name "cfs1.octopz.net".	
Odnoklassniki	Contains web traffic from "odnoklassniki.ru".	
Officedepot	Contains web traffic from "www.officedepot.com" and "www.officedepot.fr".	
Okezone	This protocol contains web traffic to the host "Okezone.com".	
Okurin	Site of introducing "Okurin" recycling packaging materials. Managed by NPO "Deep People" of people with disabilities. <a href="http://okurin.bit-park.co.jp/">http://okurin.bit-park.co.jp/</a> free file sharing service. You can choose "no registered free plan" or "registered free plan."	
OneClimate	Contains web traffic from "www.oneclimate.net".	

**TABLE I-1. Application List (Continued)**

OneWorldTV	Contains web traffic from "tv.one-world.net".	
onlinedown	Contains web traffic designated to the host "onlinedown.net".	
Ooyala	Contains web traffic designated to the hosts "l.player.ooyala.com" and "ooyala.jp", or associated to the SSL Common Name "ooyala.jp".	
Open Diary	Contains web traffic from "www.opendiary.com".	
OpenBSD Updates	OpenBSD updates	
Opera Update	Opera Update is the protocol for the update for the opera browser.	
orb	ORB is a streaming software	
Orkut	Contains web traffic from "www.orkut.com".	
OUTeverywhere	Contains web traffic from "www.outeverywhere.com".	
Paipai	This protocol contains web traffic to the host "paipai.com".	

**TABLE I-1. Application List (Continued)**

Panda Update	Panda_update is the protocol used for panda software updates.	
Pandora	Contains web traffic designated to the host "pandora.com".	
Pandora.TV	Contains web traffic designated to the host "pandora.tv".	
Paran	This protocol contains web traffic to the host "praran.com".	
PartnerUp	Contains web traffic from "www.partnerup.com".	
Party Poker	Contains web traffic associated to the SSL Common Names "partyaccount.com" and "partypoker.com".	
PassportStamp	Contains web traffic from "www.passportstamp.com".	
Pconline	This protocol contains web traffic to the host "pconline.com.cn".	
Pengyou	This protocol contains web traffic to the host "pengyou.com".	
People	This protocol contains web traffic to the host "people.com.cn".	

**TABLE I-1. Application List (Continued)**

Perfect Dark Benri-Tool		
Perfspot	Perfspot is a social networking website, enabling users to connect to relatives, friends, or unknown people and share files.	
Photobucket	Contains web traffic designated to the hosts "photobucket.com" and "register.photobucket.com".	
Pimang	This protocol contains web traffic to the host "pimang.com".	
Pingsta	Contains web traffic from "www.pingsta.com".	
PIPI Film	PP Film (aka PIPI.cn or PIPI Player) is a Chinese peer-to-peer and VOD service.	2.8.0.0
Plaxo	Contains web traffic from "www.plaxo.com".	
Playahead	Contains web traffic from "www.playahead.se".	
playstation	Contains web traffic designated to the host "playstation.com".	

**TABLE I-1. Application List (Continued)**

Plurk	Contains web traffic from "www.plurk.com".	
Pogo	Contains web traffic from "www.pogo.com".	
pps	Contains web traffic designated to the host "pps.tv".	
pptv	Contains web traffic designated to the host "pptv.com".	
Present	Contains web traffic from "presently-app.com".	
priceminister	Contains web traffic designated to the host "priceminister.com".	
PriceRunner	pricerunner is a price comparison service	
Privax	Contains web traffic designated to the host "privax.us".	
Proxeasy	Contains web traffic from "www.proxeasy.com".	
Proxono	Contains web traffic from "www.proxono.org" and "www.proxono.info".	

**TABLE I-1. Application List (Continued)**

Psiphon	Contains web traffic designated to the host "psiphon.ca".	
Qapacity	Contains web traffic from "www.qapacity.com".	
QQ.com	QQ.com is a multi-service Chinese web portal hosted by Tencent.	
Quarterlife	Contains web traffic from "www.quarterlife.com".	
Qzone	Contains web traffic from "qzone.qq.com".	
Rakuten	Rakuten is ShowTime's service host. That's why we added this protocol in ixEngine 1.2.	
Rambler	Rambler is russian information internet gate.	
Rapidshare	RapidShare is an online solution to store, send and share files	
Ravelry	Contains web traffic from "www.ravelry.com".	
Realtor	Contains web traffic from "www.realtor.com".	



**TABLE I-1. Application List (Continued)**

RedHat Update	Redhat_Update	
redtube	Contains web traffic designated to the host "redtube.com".	
Renren	Contains web traffic from "renren.com".	
Republika	This protocol contains web traffic to the host "republika.co.id".	
ResearchGATE	Contains web traffic from "www.researchgate.net".	
reuters	Contains web traffic designated to the host "reuters.com".	
ReverbNation	Contains web traffic from "www.reverbnation.com".	
reverso	Contains web traffic designated to the host "reverso.net".	
RSS	RSS is a family of web feed formats used to publish frequently updated works in a standardized format.	
rtl	Contains web traffic designated to the host "rtl.de".	

**TABLE I-1. Application List (Continued)**

Runescape	Contains web traffic from "www.runescape.com".	
ryanair	Contains web traffic designated to the host "ryanair.com".	
Ryze	Contains web traffic from "www.ryze.com".	
Saberindo	This protocol contains web traffic to the host "saberindo.co.id".	
Salesforce	Contains web traffic associated to the SSL Common Names "login.salesforce.com", "www.salesforce.com", "omtr2.partners.salesforce.com" and "emea.salesforce.com".	
SayClub	This protocol contains web traffic to the host "sayclub.com".	
SBS	This protocol contains web traffic to the host "sbs.co.kr".	
ScienceStage	Contains web traffic from "sciencesstage.com".	
Scispace	Contains web traffic from "www.scispace.com".	

**TABLE I-1. Application List (Continued)**

Scribd	This protocol contains web traffic to the host "scribd.com".	
Second Life	Second Life is an Internet-based virtual world which enables its users to interact with each other through motional avatars.	
Secure HTTP	HTTPS is the secure version of HTTP.	
Seeqpod	Contains web traffic designated to the host "intertrust.com".	
Seismic	Contains web traffic designated to the host "seismic.com".	
Segye	This protocol contains web traffic to the host "segye.com".	
Sendspace	SendSpace is an online solution to store, send and share files	
Seoul News	This protocol contains web traffic to the host ".seoul.co.kr".	
sfr	Contains web traffic designated to the host "sfr.fr".	
Share Benri-Tool	Site describes how to use the P2P software to share files in detail.	

**TABLE I-1. Application List (Continued)**

ShareTheMusic	Contains web traffic from "www.sharethemusic.com".	
Shazam	This protocol contains web traffic to the hosts "shazamid.com" and "cdn.shazam.com", or associated to the SSL Common Name "beacon.shazam.com".	
Shelfari	Contains web traffic from "www.shelfari.com".	
Shinhan	This protocol contains web traffic to the host "shinhan.com".	
ShowTime	ShowTime Video streaming site home page. Operated by Rakuten Inc.	
Shutterfly	Contains web traffic designated to the host "shutterfly.com", or associated to the SSL Common Name "shutterfly.com".	
Siebel CRM	Siebel CRM	
Sina Weibo	Sina Weibo is a Chinese micro blogging website.	
sky	Contains web traffic designated to the host "www.sky.com".	

**TABLE I-1. Application List (Continued)**

Skyblog	SkyBlog is a website where users can have blogs.	
skycn	Contains web traffic designated to the host "skycn.com".	
SkyDrive	Contains web traffic associated to the SSL Common Names "live.com.nsatc.net" and "gateway.edge.messenger.live.com".	
Skyrock	Contains web traffic from "www.skyrock.com".	
slideshare	Contains web traffic designated to the host "slideshare.net".	
Smiley Central	Smiley Central provides many funny and colorful icons (.gif animation) for IM, webmail and blog.	
Socialtv	Contains web traffic designated to the host "srv.sixdegs.com".	
SocialVibe	Contains web traffic from "www.socialvibe.com".	
Sogou	This protocol contains web traffic to the host "sogou.com".	

**TABLE I-1. Application List (Continued)**

Sohu	This protocol contains web traffic to the hosts "itc.cn" and "sohu.com".	
Soku	This protocol contains web traffic to the host "soku.com".	
Sonico	Contains web traffic from "www.sonico.com".	
Soso	This protocol contains web traffic to the host "soso.com".	
Soufun	This protocol contains web traffic to the host "soufun.com".	
Southwest	Contains web traffic from "www.southwest.com".	
spiegel	Contains web traffic designated to the host "spiegel.de".	
Sportchosun	This protocol contains web traffic to the host "sportschosun.com".	
sportsillustrated	Contains web traffic designated to the host "sportsillustrated.com".	
Sportsseoul	This protocol contains web traffic to the host "sportsseoul.com".	

**TABLE I-1. Application List (Continued)**

sprint	Contains web traffic designated to the host "sprint.com".	
Stafaband	This protocol contains web traffic to the host "Stafaband.info".	
Stagevu	Contains web traffic designated to the host "stagevu.com".	
stayfriends	Contains web traffic designated to the host "stayfriends.de".	
Stickam	Contains web traffic from "www.stickam.com".	
StreamAudio	Contains web traffic designated to the host "streamaudio.com".	
StudiVZ	Contains web traffic from "www.studivz.net".	
StumbleUpon	Contains web traffic from "www.stumbleupon.com".	
Sugar CRM	Sugar CRM, a client relationship management solution.	Sugar CRM 6.2.1 - Build 6405
Suppersoccer	This protocol contains web traffic to the host "m.supersoccer.co.id".	

**TABLE I-1. Application List (Continued)**

Surrogafier	Contains web traffic from "www.surrogafier.info".	
surveymonkey	Contains web traffic designated to the host "surveymonkey.com".	
SVT Play	Contains web traffic designated to the hosts "svt.se" and "ld-svt-se.sites-tat.com".	
Symantec Norton AntiVirus Updates	Virus definitions and engine updates for the Symantec Norton anti-virus.	
Tagged	Tagged is a social networking website, enabling users to connect to relatives, friends, or unknown people.	
Tagoo	Contains web traffic designated to the host "tagoo.ru", or associated to the SSL Common Name "tagoo.ru".	
Taku File Bin	Contains web traffic designated to the hosts "wwwa.filesend.to", "www.filesend.to", "web11.filesend.to" and "search.filesend.to", or associated to the SSL Common Name ".filesend.to".	
TalentTrove	Contains web traffic from "lafango.com".	
Talkbiznow	Contains web traffic from "www.talkbiznow.com".	



**TABLE I-1. Application List (Continued)**

Taltopia	Contains web traffic from "www.taltopia.com".	
Taobao	This protocol contains web traffic to the hosts "taobaocdn.com" and "taobao.com", or associated to the SSL Common Name "login.taobao.com".	
Taringa	Contains web traffic from "www.taringa.net".	
Tchatte	Tchatte is an instant messaging website.	
TeacherTube	Contains web traffic designated to the hosts "teachertube.com" and "teachertube.biz".	
TeachStreet	Contains web traffic from "www.teachstreet.com".	
Techinline	Contains web traffic designated to the host "techinline.com", or associated to the SSL Common Name "techinline.com".	
TempoInteraktif	This protocol contains web traffic to the hosts "TempoInteraktif.com" and "tempo.co".	

**TABLE I-1. Application List (Continued)**

Tencent (QQ) WeiBo	QQ WeiBo is a Chinese Twitter-like micro-blogging website. It is part of Tencent's QQ.	
tf1	Contains web traffic designated to the host "tf1.fr".	
The Auteurs	Contains web traffic from "www.theauteurs.com".	
Three.co	This protocol contains web traffic to the host "three.co.id".	
Tianya	This protocol contains web traffic to the host "tianya.cn".	
Ticketmonster	This protocol contains web traffic to the host "ticketmonster.co.kr".	
TidalTV	Contains web traffic designated to the host "portal.tidaltv.com".	
Tistory	This protocol contains web traffic to the host "tistory.com".	
Tmall	This protocol contains web traffic to the host "tmall.com".	

**TABLE I-1. Application List (Continued)**

Tokbox	Contains web traffic designated to the host "tokbox.com", or associated to the SSL Common Name "cm.tokbox.com".	
Tokobagus	This protocol contains web traffic to the host "Tokobagus.com".	
torrentdownloads	Contains web traffic designated to the host "torrentdownloads.net".	
torrentz	Contains web traffic designated to the hosts "torrentz.com" and "torrentz.eu".	
TravBuddy	Contains web traffic from "www.travbuddy.com".	
Travellerspoint	Contains web traffic from "www.travelerspoint.com".	
Travelocity	Contains web traffic from "www.travelocity.com".	
Travian	This protocol contains web traffic to the host "Travian.co.id".	
Tribe	Contains web traffic from "www.tribe.net".	

**TABLE I-1. Application List (Continued)**

Tribunnews	This protocol contains web traffic to the host "tribunnews.com".	
Trombi	Contains web traffic from "www.trombi.com".	
tu	Contains web traffic designated to the host "tu.tv".	
tube8	Contains web traffic designated to the host "tube8.com".	
Tudou	Contains web traffic designated to the hosts "tudou.com" and "at-img4.tdimg.com".	
Tuenti	Contains web traffic from "www.tuenti.com".	
Tumblr	Contains web traffic from "www.tumblr.com".	
tv	Contains web traffic designated to the host "tv.com".	
Tv4Play	Contains web traffic designated to the hosts "tv4play.se" and "cdn01.tv4.se", or associated to the SSL Common Name "ec2-184-73-252-58.compute-1.amazonaws.com".	

**TABLE I-1. Application List (Continued)**

Twitpic	Contains web traffic designated to the host "twitpic.com", or associated to the SSL Common Names "twitter.com" and "twitpic.com".	
Twitter	Contains web traffic from "twitter.com".	
univision	Contains web traffic designated to the host "univision.com".	
uploading	Contains web traffic designated to the host "uploading.com".	
usatoday	Contains web traffic designated to the host "usatoday.com".	
Usejump	Contains web traffic associated to the SSL Common Name "beta.use-jump.com".	
Ustream	Contains web traffic designated to the host "ustream.tv".	
VampireFreaks	Contains web traffic from "www.vampirefreaks.com".	
Veetle	Contains web traffic designated to the host "veetle.com".	

**TABLE I-1. Application List (Continued)**

Viadeo	Contains web traffic from "www.viadeo.com".	
videobash	Contains web traffic designated to the host "videobash.com".	
videosurf	Contains web traffic designated to the host "videosurf.com".	
vietbao	Contains web traffic designated to the host "vietbao.vn".	
vimeo	Contains web traffic designated to the host "vimeo.com".	
Vivanews	This protocol contains web traffic to the hosts "Vivanews.com" and "viva.co.id".	
Vkontakte	Contains web traffic from "odnoklassniki.ru".	
Vox	Contains web traffic from "www.vox.com".	
Vtunnel	Contains web traffic from "www.vtunnel.com" and "www.vtunnel.info".	
Vyew	Contains web traffic designated to the host "vyew.com", or associated to the SSL Common Name "vyew.com".	

**TABLE I-1. Application List (Continued)**

Wakoopa	Contains web traffic from "wakoopa.com".	
Wasabi	Contains web traffic from "wasabi.com".	
washingtonpost	Contains web traffic designated to the host "washingtonpost.com".	
wat	Contains web traffic designated to the host "wat.tv".	
Wayn	Contains web traffic from "www.wayn.com".	
weather	Contains web traffic designated to the hosts "weather.com" and "weather.com.cn".	
Web Crawler	Contains web traffic designated to the host "webcrawler.com".	
WebBiographies	Contains web traffic from "www.webbiographies.com".	
WeOurFamily	Contains web traffic from "www.weourfamily.com".	
WerKenntWen	Contains web traffic from "www.wer-kennt-wen.de".	

**TABLE I-1. Application List (Continued)**

Wikipedia	Wikipedia is the biggest multilingual free-content encyclopedia on the Internet.	
Windows Update	Windows_update is the protocol used for windows system updates.	
Windowslive	Contains web traffic from "home.spaces.live.com" and www.windowslive.fr".	
WindowsLiveSpace	Contains web traffic from "login.live.com".	
windowsmedia	Contains web traffic designated to the host "windowsmedia.com".	
Winnyp	A variety of Winny, enhanced by encrypting the communication of winny. Brothersoft is a site that has been opened to the public free software without permission.	
WiserEarth	Contains web traffic from "www.wiserearth.org".	
Wixi	Contains web traffic designated to the host "wixi.com".	
Wooribank	This protocol contains web traffic to the host "wooribank.com".	



**TABLE I-1. Application List (Continued)**

Wordpress	Contains web traffic from "wordpress.com".	
Xanga	Contains web traffic from "www.xanga.com".	
xbox	Contains web traffic designated to the host "xbox.com".	
Xing	Contains web traffic from "www.xing.com".	
Xinhuanet	This protocol contains web traffic to the host "xinhuanet.com".	
XL wap	This protocol contains web traffic to the host "wap.xl.co.id".	
XL Webmail	This protocol contains web traffic to the host "webmail.xl.co.id".	
XLNet	This protocol contains web traffic to the host "xl.net.id".	
XM Radio	Contains web traffic designated to the host "xmradio.com".	

**TABLE I-1. Application List (Continued)**

XMLRPC protocol	It's remote procedure calling using HTTP as the transport and XML as the encoding. XML-RPC is designed to be as simple as possible, while allowing complex data structures to be transmitted, processed and returned.	
xnxx	Contains web traffic designated to the host "xnxx.com".	
xrea	Contains web traffic designated to the host "xrea.com".	
Xt3	Contains web traffic from "www.xt3.com".	
xvideos	Contains web traffic designated to the host "xvideos.com".	
xvideolive	Contains web traffic designated to the host "xvideolive.com".	
Yahoo answers	Contains web traffic from "answers.yahoo.com".	
Yahoo biz	Contains web traffic from "fr.biz.yahoo.com" and "finance.yahoo.com".	
Yahoo Douga	Contains web traffic designated to the host "www.yahoo.co.jp".	

**TABLE I-1. Application List (Continued)**

Yahoo games	Contains web traffic from "games.yahoo.com".	
Yahoo geocities	Contains web traffic from "geocities.yahoo.com".	
Yahoo Korea	This protocol contains web traffic to the host "yahoo.co.kr".	
Yahoo maps	Contains web traffic from "maps.yahoo.com".	
Yahoo realestate	Contains web traffic from "realestate.yahoo.com".	
Yahoo search	This protocol is used to send queries to the Yahoo search engine.	
Yahoo travel	Contains web traffic from "travel.yahoo.com" and "fr.voyage.yahoo.com".	
Yahoo360PlusVietnam	Contains web traffic from "vn.360plus.yahoo.com".	
yahoo-box	online storage services provided by yahoo japan	
Yammer	Contains web traffic from "www.yammer.com".	

**TABLE I-1. Application List (Continued)**

Yandex	Yandex is Russian information internet gate.	
Yelp	Contains web traffic from "www.yelp.com".	
Yesky	This protocol contains web traffic to the host "yesky.com".	
youdao	Contains web traffic designated to the host "youdao.com".	
Youku	Contains web traffic designated to the host "static.youku.com".	
youn7	Contains web traffic designated to the host "youn7.com".	
Youmeo	Contains web traffic from "calumbrannan.com".	
youporn	Contains web traffic designated to the host "youporn.com".	
YourFileHost	Contains web traffic designated to the host "yourfilehost.com".	
YouSeeMore	Contains web traffic designated to the host "youseemore.com".	

**TABLE I-1. Application List (Continued)**

YouSendIt	Contains web traffic associated to the SSL Common Name "yousendit.com".	
YouTube	YouTube is a website where users can send or watch videos.	
YouTube HD	YouTube HD is the new version of YouTube where users can send or watch videos in High Definition.	
Yting	Contains web traffic designated to the host ".yting.com".	
Yugma	Contains web traffic designated to the host "yugma.com", or associated to the SSL Common Name "yugma.com".	
Yuuguu	Contains web traffic designated to the host "share.yuuguu.com", or associated to the SSL Common Name "share.yuuguu.com".	
Zelune	Contains web traffic from "www.zelune.info".	
Ziddu	This protocol contains web traffic to the host "ziddu.com".	

**TABLE I-1. Application List (Continued)**

Zoho CRM	Contains web traffic designated to the host "crm.zoho.com", or associated to the SSL Common Name "crm.zoho.com".	
ZOHO DB and Reports	The ZOHO DB and Reports is an online database and reporting application.	
Zoho Meeting	Contains web traffic designated to the hosts "wms8.zoho.com", "chat.zoho.com" and "meeting.zoho.com", or associated to the SSL Common Name "meeting.zoho.com".	
Zoho People	Contains web traffic designated to the host "wms2.zoho.com".	
Zol	This protocol contains web traffic to the host "zol.com.cn".	
Zoo	Contains web traffic from "www.zoo.gr".	
Zshare	zShare is an online solution to store, send and share files	
Zum	This protocol contains web traffic to the host "zum.com".	

# Glossary of Terms

This glossary describes special terms as used in this document or the Online Help.

TERM	EXPLANATION
"Zip of Death"	A zip (or archive) file of a type that when decompressed, expands enormously (for example 1000 percent) or a zip file with thousands of attachments. Compressed files must be decompressed during scanning. Huge files can slow or stop your network.
"in the wild"	Describes known viruses that are actively circulating. <i>Also see "in the zoo."</i>
"in the zoo"	Describes known viruses that are currently controlled by antivirus products. <i>Also see "in the wild."</i>
(administrative) domain	A group of computers sharing a common database and security policy.
100BaseT	An alternate term for "fast Ethernet," an upgraded standard for connecting computers into a local area network (LAN). 100BaseT Ethernet can transfer data at a peak rate of 100 Mbps. It is also more expensive and less common than 10BaseT. <i>Also see 10BaseT.</i>
10BaseT	The most common form of Ethernet is called 10BaseT, which denotes a peak transmission speed of 10 Mbps using copper twisted-pair cable. Ethernet is a standard for connecting computers into a local area network (LAN). The maximum cable distance is 100 meters (325 feet), the maximum devices per segment is 1, and the maximum devices per network are 1024. <i>Also see 100BaseT.</i>
access (noun)	Authorization to read or write data. Most operating systems allow you to define different levels of access, depending on job responsibilities.

TERM	EXPLANATION
access (verb)	To read data from or write data to a storage device, such as a computer or server.
action <i>(Also see target and notification)</i>	The operation to be performed when: <ul style="list-style-type: none"><li>- a virus has been detected</li><li>- spam has been detected</li><li>- a content violation has occurred</li><li>- an attempt was made to access a blocked URL, or</li><li>- file blocking has been triggered.</li></ul> Actions typically include clean and deliver, quarantine, delete, or deliver/transfer anyway. Delivering/transferring anyway is not recommended—delivering a virus-infected message or transferring a virus-infected file can compromise your network.
activate	To enable your software after completion of the registration process. Trend Micro products are not operable until product activation is complete. Activate during installation or after installation (in the Web console) on the Product License screen.
Activation Code	A 37-character code, including hyphens, that is used to activate Trend Micro products. Here is an example of an Activation Code: SM-9UE7-HG5B3-8577B-TD5P4-Q2XT5-48PG4 <i>Also see Registration Key.</i>
active FTP	Configuration of FTP protocol that allows the client to initiate “handshaking” signals for the command session, but the host initiates the data session.
active/passive pair	A cluster composed of two machines contains one machine is active for traffic scan, while the other machine is passive and does not scan traffic. The passive device works as backup of to the active device to meet high availability requirements.



TERM	EXPLANATION
ActiveUpdate	ActiveUpdate is a function common to many Trend Micro products. Connected to the Trend Micro update Web site, ActiveUpdate provides up-to-date downloads of virus pattern files, scan engines, and program files through the Internet or the Trend Micro Total Solution CD or DVD.
ActiveUpdate	A Trend Micro utility that enables on-demand or background updates to the virus pattern file and scan engine, as well as the anti-spam rules database and anti-spam engine.
ActiveX	A type of open software architecture that implements object linking and embedding, enabling some of the standard interfaces, such as downloading of Web pages.
ActiveX malicious code	<p>An ActiveX control is a component object embedded in a Web page which runs automatically when the page is viewed. ActiveX controls allow Web developers to create interactive, dynamic Web pages with broad functionality such as HouseCall, Trend Micro's free online scanner.</p> <p>Hackers, virus writers, and others who want to cause mischief or worse might use ActiveX malicious code as a vehicle to attack the system. In many cases, the Web browser can be configured so that these ActiveX controls do not execute by changing the browser's security settings to "high."</p>
address	Refers to a networking address (see IP address) or an email address, which is the string of characters that specify the source or destination of an email message.

<b>TERM</b>	<b>EXPLANATION</b>
administrator	Refers to “system administrator”—the person in an organization who is responsible for activities such as setting up new hardware and software, allocating user names and passwords, monitoring disk space and other IT resources, performing backups, and managing network security.
administrator account	A user name and password that has administrator-level privileges.
administrator email address	The address used by the administrator of your Trend Micro product to manage notifications and alerts.
adware	Advertising-supported software in which advertising banners appear while the program is running. Adware that installs a “back door”; tracking mechanism on the user's computer without the user's knowledge is called “spyware.”
alert	A message intended to inform a system's users or administrators about a change in the operating conditions of that system or about some kind of error condition.
anti-relay	Mechanisms to prevent hosts from “piggybacking” through another host's network.
antivirus	Computer programs designed to detect and clean computer viruses.
archive	A single file containing one or (usually) more separate files plus information to allow them to be extracted (separated) by a suitable program, such as a .zip file.
attachment	A file attached to (sent with) an email message.
audio/video file	A file containing sounds, such as music, or video footage.

TERM	EXPLANATION
authentication	<p>The verification of the identity of a person or a process. Authentication ensures that digital data transmissions are delivered to the intended receiver. Authentication also assures the receiver of the integrity of the message and its source (where or whom it came from).</p> <p>The simplest form of authentication requires a user name and password to gain access to a particular account. Authentication protocols can also be based on secret-key encryption, such as the Data Encryption Standard (DES) algorithm, or on public-key systems using digital signatures.</p> <p><i>Also see public-key encryption and digital signature.</i></p>
binary	<p>A number representation consisting of zeros and ones used by practically all computers because of its ease of implementation using digital electronics and Boolean algebra.</p>
block	<p>To prevent entry into your network.</p>
bridge	<p>A device that forwards traffic between network segments based on data link layer information. These segments have a common network layer address.</p>
browser	<p>A program which allows a person to read hypertext, such as Internet Explorer. The browser gives some means of viewing the contents of nodes (or "pages") and of navigating from one node to another. A browser acts as a client to a remote Web server.</p>
cache	<p>A small fast memory, holding recently accessed data, designed to speed up subsequent access to the same data. The term is most often applied to processor-memory access, but also applies to a local copy of data accessible over a network etc.</p>

<b>TERM</b>	<b>EXPLANATION</b>
case-matching	Scanning for text that matches both words and case. For example, if “dog” is added to the content-filter, with case-matching enabled, messages containing “Dog” pass through the filter; messages containing “dog” do not.
cause	The reason a protective action, such as URL-blocking or file-blocking, was triggered—this information appears in log files.
child	The non-parent machine in a cluster, the child machine is the passive machine for active/passive scenario. Child members receive synchronized configurations from parent device.
clean	To remove virus code from a file or message.
client	A computer system or process that requests a service of another computer system or process (a "server") using some kind of protocol and accepts the server's responses. A client is part of a client-server software architecture.
client-server environment	A common form of distributed system in which software is split between server tasks and client tasks. A client sends requests to a server, according to some protocol, asking for information or action, and the server responds.
cluster	A group of machines form a cluster; and the machines in the cluster will share almost the same policies and configurations. Administrators can use the Web UI on the parent member via floating (or cluster) IP address to manage centralized policies and configurations.

<b>TERM</b>	<b>EXPLANATION</b>
cluster IP address	An IWSVA cluster has a floating IP address; administrators can always use the floating IP address to manage the cluster from Web UI and CLI. The floating (or cluster) IPv4 or IPv6 IP address remains associated with the cluster and always points to the parent member of the cluster, even when switchover or failover occurs.
cluster-level settings	IWSVA policies and settings which can be centrally managed in cluster.
compressed file	A single file containing one or more separate files plus information to allow them to be extracted by a suitable program, such as WinZip.
configuration	Selecting options for how your Trend Micro product will function, for example, selecting whether to quarantine or delete a virus-infected email message.
content filtering	Scanning email messages for content (words or phrases) prohibited by your organization's Human Resources or IT messaging policies, such as hate mail, profanity, or pornography.
content violation	An event that has triggered the content filtering policy.
cookie	A mechanism for storing information about an Internet user, such as name, preferences, and interests, which is stored in your Web browser for later use. The next time you access a Web site for which your browser has a cookie, your browser sends the cookie to the Web server, which the Web server can then use to present you with customized Web pages. For example, you might enter a Web site that welcomes you by name.

TERM	EXPLANATION
daemon	A program that is not invoked explicitly, but lies dormant waiting for some condition(s) to occur. The perpetrator of the condition need not be aware that a daemon is lurking.
damage routine	The destructive portion of virus code, also called the payload.
De-Militarized Zone (DMZ)	From the military term for an area between two opponents where fighting is prevented. DMZ Ethernets connect networks and computers controlled by different bodies. They might be external or internal. External DMZ Ethernets link regional networks with routers.
default	A value that pre-populates a field in the Web console interface. A default value represents a logical choice and is provided for convenience. Use default values as-is, or change them.
Deployment Wizard	A Web console-based wizard, which is used for ease of deployment. Deployment-related configurations have been removed from the product installation to this wizard.
dialer	A type of Trojan that when executed, connects the user's system to a pay-per-call location in which the unsuspecting user is billed for the call without his or her knowledge.
digital signature	Extra data appended to a message which identifies and authenticates the sender and message data using a technique called public-key encryption. <i>Also see public-key encryption and authentication.</i>
directory	A node, which is part of the structure in a hierarchical computer file system. A directory typically contains other nodes, folders, or files. For example, <i>C:\Windows</i> is the Windows directory on the C drive.

TERM	EXPLANATION
directory path	The subsequent layers within a directory where a file can be found, for example, the directory path for the ISVW for SMB Quarantine directory is: <i>C:\Programs\Trend Micro\ISVW\Quarantine</i>
disclaimer	A statement appended to the beginning or end of an email message, that states certain terms of legality and confidentiality regarding the message, To see an example, click the Online Help for the <b>SMTP Configuration - Disclaimer</b> screen.
DNS	Domain Name System—A general-purpose data query service chiefly used on the Internet for translating host names into IP addresses.
DNS resolution	When a DNS client requests host name and address data from a DNS server, the process is called resolution. Basic DNS configuration results in a server that performs default resolution. For example, a remote server queries another server for data on a machine in the current zone. Client software on the remote server queries the resolver, which answers the request from its database files.
domain name	The full name of a system, consisting of its local host name and its domain name, for example, tellsitall.com. A domain name should be sufficient to determine a unique Internet address for any host on the Internet. This process, called “name resolution”, uses the Domain Name System (DNS).
DoS (Denial of Service) attack	Group-addressed email messages with large attachments that clog your network resources to the point where messaging service is noticeably slow or even stopped.

TERM	EXPLANATION
DOS virus	Also referred to as "COM" and "EXE file infectors." DOS viruses infect DOS executable programs- files that have the extensions *.COM or *.EXE. Unless they have overwritten or inadvertently destroyed part of the original program's code, most DOS viruses try to replicate and spread by infecting other host programs.
download (noun)	Data that has been downloaded, for example, from a Web site through HTTP.
download (verb)	To transfer data or code from one computer to another. Downloading often refers to transfer from a larger "host" system (especially a server or main-frame) to a smaller "client" system.
dropper	Droppers are programs that serve as delivery mechanisms to carry and drop viruses, Trojans, or worms into a system.
ELF	Executable and Linkable Format—An executable file format for UNIX and Linux platforms.
encryption	Encryption is the process of changing data into a form that can be read only by the intended receiver. To decipher the message, the receiver of the encrypted data must have the proper decryption key. In traditional encryption schemes, the sender and the receiver use the same key to encrypt and decrypt data. Public-key encryption schemes use two keys: a public key, which anyone might use, and a corresponding private key, which is possessed only by the person who created it. With this method, anyone might send a message encrypted with the owner's public key, but only the owner has the private key necessary to decrypt it. PGP (Pretty Good Privacy) and DES (Data Encryption Standard) are two of the most popular public-key encryption schemes.



TERM	EXPLANATION
End User License Agreement (EULA)	<p>An End User License Agreement or EULA is a legal contract between a software publisher and the software user. It typically outlines restrictions on the side of the user, who can refuse to enter into the agreement by not clicking "I accept" during installation. Clicking "I do not accept" will, of course, end the installation of the software product.</p> <p>Many users inadvertently agree to the installation of spyware and adware into their computers when they click "I accept" on EULA prompts displayed during the installation of certain free software.</p>
Ethernet	<p>A local area network (LAN) technology invented at the Xerox Corporation, Palo Alto Research Center. Ethernet is a best-effort delivery system that uses CSMA/CD technology. Ethernet can be run over a variety of cable schemes, including thick coaxial, thin coaxial, twisted pair, and fiber optic cable. Ethernet is a standard for connecting computers into a local area network. The most common form of Ethernet is called 10BaseT, which denotes a peak transmission speed of 10 Mbps using copper twisted-pair cable.</p>
EXE file infector	<p>An executable program with a .exe file extension. <i>Also see DOS virus.</i></p>
executable file	<p>A binary file containing a program in machine language which is ready to be executed (run).</p>
exploit	<p>An exploit is code that takes advantage of a software vulnerability or security hole. Exploits are able to propagate into and run intricate routines on vulnerable computers.</p>
failover	<p>When a parent member of a cluster crashes or fails to handle traffic, IWSVA automatically performs a switchover in the cluster and elects a new machine to fill the role of the parent member of the cluster.</p>

<b>TERM</b>	<b>EXPLANATION</b>
false positive	An email message that was "caught" by the spam filter and identified as spam, but is actually not spam.
FAQ	Frequently Asked Questions—A list of questions and answers about a specific topic.
file	An element of data, such as an email message or HTTP download.
file name extension	The portion of a file name (such as .dll or .xml) which indicates the kind of data stored in the file. Apart from informing the user what type of content the file holds, file name extensions are typically used to decide which program to launch when a file is run.
file type	The kind of data stored in a file. Most operating systems use the file name extension to determine the file type. The file type is used to choose an appropriate icon to represent the file in a user interface, and the correct application with which to view, edit, run, or print the file.
file-infecting virus	<p>File-infecting viruses infect executable programs (generally, files that have extensions of .com or .exe). Most such viruses simply try to replicate and spread by infecting other host programs, but some inadvertently destroy the program they infect by overwriting a portion of the original code. A minority of these viruses are very destructive and attempt to format the hard drive at a pre-determined time or perform some other malicious action.</p> <p>In many cases, a file-infecting virus can be successfully removed from the infected file. However, if the virus has overwritten part of the program's code, the original file will be unrecoverable</p>

TERM	EXPLANATION
filtering, dynamic	IP service that can be used within VPN tunnels. Filters are one way GateLock controls traffic from one network to another. When TCP/IP sends data packets to the firewall, the filtering function in the firewall looks at the header information in the packets and directs them accordingly. The filters operate on criteria such as IP source or destination address range, TCP ports, UDP, Internet Control Message Protocol (ICMP), or TCP responses. Also see tunneling and Virtual Private Network (VPN).
firewall	A gateway machine with special security precautions on it, used to service outside network (especially Internet) connections and dial-in lines.
floating IP address	See cluster IP address.
FTP	A client-server protocol which allows a user on one computer to transfer files to and from another computer over a TCP/IP network. Also refers to the client program the user executes to transfer files.
gateway	An interface between an information source and a Web server.
grayware	A category of software that might be legitimate, unwanted, or malicious. Unlike threats such as viruses, worms, and Trojans, grayware does not infect, replicate, or destroy data, but it might violate your privacy. Examples of grayware include spyware, adware, and remote access tools.
group file type	Types of files that have a common theme, for example: <ul style="list-style-type: none"><li>- Audio/Video</li><li>- Compressed</li><li>- Executable</li><li>- Images</li><li>- Java</li><li>- Microsoft Office</li></ul>

TERM	EXPLANATION
GUI	Graphical User Interface—The use of pictures rather than just words to represent the input and output of a program. This contrasts with a command line interface where communication is by exchange of strings of text.
HA	See High Availability
hacking tool	Tools such as hardware and software that enables penetration testing of a computer system or network for the purpose of finding security vulnerabilities that can be exploited.
hard disk (or hard drive)	One or more rigid magnetic disks rotating about a central axle with associated read/write heads and electronics, used to read and write hard disks or floppy disks, and to store data. Most hard disks are permanently connected to the drive (fixed disks) though there are also removable disks.
header (networking definition)	Part of a data packet that contains transparent information about the file or the transmission.
heuristic rule-based scanning	Scanning network traffic, using a logical analysis of properties that reduces or limits the search for solutions.
High Availability	High availability uses a second unit or node to ensure that the services are available even if the first unit breaks down.
host	A computer connected to a network.
HTTP	Hypertext Transfer Protocol—The client-server TCP/IP protocol used on the World Wide Web for the exchange of HTML documents. It conventionally uses port 80.
HTTPS	Hypertext Transfer Protocol Secure—A variant of HTTP used for handling secure transactions.

TERM	EXPLANATION
hub	This hardware is used to network computers together (usually over an Ethernet connection). It serves as a common wiring point so that information can flow through one central location to any other computer on the network thus enabling centralized management. A hub is a hardware device that repeats signals at the physical Ethernet layer. A hub retains the behavior of a standard bus type network (such as Thinnnet), but produces a star topology with the hub at the center of the star. This configuration enables centralized management.
ICSA	ICSA Labs is an independent division of TruSecure Corporation. For over a decade, ICSA has been the security industry's central authority for research, intelligence, and certification testing of products. ICSA Labs sets standards for information security products and certifies over 90 percent of the installed base of antivirus, firewall, IPSec, cryptography, and PC firewall products in the world today.
image file	A file containing data representing a two-dimensional scene, in other words, a picture. Images are taken from the real world, for example, through a digital camera, or they might be generated by computer using graphics software.
incoming	Email messages or other data routed <i>into</i> your network.
installation script	The installation screens used to install UNIX versions of Trend Micro products.
instance-level settings	IWSVA policies and settings which only apply to individual instances.
integrity checking	See checksumming.

TERM	EXPLANATION
IntelliScan	IntelliScan is a Trend Micro scanning technology that optimizes performance by examining file headers using true-file type recognition, and scanning only file types known to potentially harbor malicious code. True-file type recognition helps identify malicious code that can be disguised by a harmless extension name.
Internet	A client-server hypertext information retrieval system, based on a series of networks connected with routers. The Internet is a modern information system and a widely accepted medium for advertising, online sales, and services, as well as university and many other research networks. The World Wide Web is the most familiar aspect of the Internet.
Internet Bots	Web robots, or simply bots, are software applications that are often used to initiate attacks to a specific target, such as DDoS attack. They are an ever increasing threat to business networks, individuals, and the Internet in general. If they are present in the enterprise environment, they could consume a significant amount of network bandwidth and computing power. They could also incur some legal liabilities to a company.
Internet Protocol (IP)	An Internet standard protocol that defines a basic unit of data called a datagram. A datagram is used in a connectionless, best-effort, delivery system. The Internet protocol defines how information gets passed between systems across the Internet.
interrupt	An asynchronous event that suspends normal processing and temporarily diverts the flow of control through an "interrupt handler" routine.
intranet	Any network which provides similar services within an organization to those provided by the Internet outside it, but which is not necessarily connected to the Internet.

TERM	EXPLANATION
IP	Internet Protocol—See IP address.
IP address	Internet address for a device on a network, typically expressed using dot notation such as 123.123.123.123.
IP gateway	Also called a router, a gateway is a program or a special-purpose device that transfers IP datagrams from one network to another until the final destination is reached.
IT	Information technology, to include hardware, software, networking, telecommunications, and user support.
Java applets	<p>Java applets are small, portable Java programs embedded in HTML pages that can run automatically when the pages are viewed. Java applets allow Web developers to create interactive, dynamic Web pages with broader functionality.</p> <p>Authors of malicious code have used Java applets as a vehicle for attack. Most Web browsers, however, can be configured so that these applets do not execute - sometimes by simply changing browser security settings to "high."</p>
Java file	Java is a general-purpose programming language developed by Sun Microsystems. A Java file contains Java code. Java supports programming for the Internet in the form of platform-independent Java "applets." (An applet is a program written in Java programming language that can be included in an HTML page. When you use a Java-technology enabled browser to view a page that contains an applet, the applet's code is transferred to your system and is executed by the browser's Java Virtual Machine.)

TERM	EXPLANATION
Java malicious code	Virus code written or embedded in Java. <i>Also see</i> Java file.
JavaScript virus	<p>JavaScript is a simple programming language developed by Netscape that allows Web developers to add dynamic content to HTML pages displayed in a browser using scripts. Javascript shares some features of Sun Microsystems Java programming language, but was developed independently.</p> <p>A JavaScript virus is a virus that is targeted at these scripts in the HTML code. This enables the virus to reside in Web pages and download to a user's desktop through the user's browser.</p> <p><i>Also see</i> VBscript virus.</p>
joke program	An executable program that is annoying or causes users undue alarm. Unlike viruses, joke programs do not self-propagate and should simply be removed from your system.
KB	Kilobyte—1024 bytes of memory.
keylogger	Keyloggers are programs that catch and store all keyboard activity. There are legitimate keylogging programs that are used by corporations to monitor employees and by parents to monitor their children. However, criminals also use keystroke logs to sort for valuable information such as logon credentials and credit card numbers.
LAN (Local Area Network)	A data communications network which is geographically limited, allowing easy interconnection of computers within the same building.



<b>TERM</b>	<b>EXPLANATION</b>
LDAP (Lightweight Directory Access Protocol)	An internet protocol that email programs use to locate contact information from a server. For example, suppose you want to locate all persons in Boston who have an email address containing the name "Bob." An LDAP search would enable you to view the email addresses that meet this criteria.
license	Authorization by law to use a Trend Micro product.
license certificate	A document that proves you are an authorized user of a Trend Micro product.
link (also called hyperlink)	A reference from some point in one hypertext document to some point in another document or another place in the same document. Links are usually distinguished by a different color or style of text, such as underlined blue text. When you activate the link, for example, by clicking on it with a mouse, the browser displays the target of the link.
listening port	A port utilized for client connection requests for data exchange.
load balancing	Load balancing is the mapping (or re-mapping) of work to processors, with the intent of improving the efficiency of a concurrent computation.
local area network (LAN)	Any network technology that interconnects resources within an office environment, usually at high speeds, such as Ethernet. A local area network is a short-distance network used to link a group of computers together within a building. 10BaseT Ethernet is the most commonly used form of LAN. A hardware device called a hub serves as the common wiring point, enabling data to be sent from one machine to another over the network. LANs are typically limited to distances of less than 500 meters and provide low-cost, high-bandwidth networking capabilities within a small geographical area.

TERM	EXPLANATION
log storage directory	Directory on your server that stores log files.
logic bomb	Code surreptitiously inserted into an application or operating system that causes it to perform some destructive or security-compromising activity whenever specified conditions are met.
macro	A command used to automate certain functions within an application.
macro virus	Macro viruses are often encoded as an application macro and included in a document. Unlike other virus types, macro viruses aren't specific to an operating system and can spread through email attachments, Web downloads, file transfers, and cooperative applications.
MacroTrap	A Trend Micro utility that performs a rule-based examination of all macro code that is saved in association with a document. macro virus code is typically contained in part of the invisible template that travels with many documents (.dot, for example, in Microsoft Word documents). MacroTrap checks the template for signs of a macro virus by seeking out key instructions that perform virus-like activity—instructions such as copying parts of the template to other templates (replication), or instructions to execute potentially harmful commands (destruction).
malware (malicious software)	Programming or files that are developed for the purpose of doing harm, such as viruses, worms, and Trojans.
mass mailer (also known as a Worm)	A malicious program that has high damage potential, because it causes large amounts of network traffic.
MB	Megabyte—1024 kilobytes of data.
Mbps	Millions of bits per second—a measure of bandwidth in data communications.

TERM	EXPLANATION
Media Access Control (MAC) address	An address that uniquely identifies the network interface card, such as an Ethernet adapter. For Ethernet, the MAC address is a 6 octet address assigned by IEEE. On a LAN or other network, the MAC address is a computer's unique hardware number. (On an Ethernet LAN, it's the same as the Ethernet address.) When you're connected to the Internet from your computer (or host as the Internet protocol thinks of it), a correspondence table relates your IP address to your computer's physical (MAC) address on the LAN. The MAC address is used by the Media Access Control sublayer of the Data-Link Control (DLC) layer of telecommunication protocols. There is a different MAC sublayer for each physical device type.
Microsoft Office file	Files created with Microsoft Office tools such as Excel or Microsoft Word.
mixed threat attack	Complex attacks that take advantage of multiple entry points and vulnerabilities in enterprise networks, such as the "Nimda" or "Code Red" threats.
MTA (Mail Transfer Agent)	The program responsible for delivering email messages. <i>Also see</i> SMTP server.
Network Address Translation (NAT)	A standard for translating secure IP addresses to temporary, external, registered IP address from the address pool. This allows Trusted networks with privately assigned IP addresses to have access to the Internet. This also means that you don't have to get a registered IP address for every machine in your network.
Network Content Inspection Engine (NCIE)	An engine that can detect bots or Web robots from Core Tech.

TERM	EXPLANATION
network virus	A type of virus that uses network protocols, such as TCP, FTP, UDP, HTTP, and email protocols to replicate. Network viruses often do not alter system files or modify the boot sectors of hard disks. Instead, they infect the memory of client machines, forcing them to flood the network with traffic, which can cause slowdowns or even complete network failure.
notification (Also see action and target)	A message that is forwarded to one or more of the following: <ul style="list-style-type: none"><li>- system administrator</li><li>- sender of a message</li><li>- recipient of a message, file download, or file transfer</li></ul> The purpose of the notification is to communicate that a prohibited action has taken place, or was attempted, such as a virus being detected in an attempted HTTP file download.
offensive content	Words or phrases in messages or attachments that are considered offensive to others, for example, profanity, sexual harassment, racial harassment, or hate mail.
Online Help	Documentation that is bundled with the GUI.
open source	Programming code that is available to the general public for use or modification free of charge and without license restrictions.
operating system	The software which handles tasks such as the interface to peripheral hardware, scheduling tasks, and allocating storage. In this documentation, the term also refers to the software that presents a window system and graphical user interface.
outgoing	Email messages or other data <i>leaving</i> your network, routed out to the Internet.

TERM	EXPLANATION
parameter	A variable, such as a range of values (a number from 1 to 10).
parent	The central point of the cluster, a parent is the active machine for active/passive scenario. Administrators perform central management on the parent member, and cluster-level configurations are synchronized to the child member.
partition	A logical portion of a disk. (Also see sector, which is a physical portion of a disk.)
passive FTP	Configuration of FTP protocol that allows clients within your local area network to initiate the file transfer, using random upper port numbers (1024 and above).
password cracker	An application program that is used to recover a lost or forgotten password. These applications can also be used by an intruder to gain unauthorized access to a computer or network resources.
pattern file (also known as Official Pattern Release)	The pattern file, as referred to as the Official Pattern Release (OPR), is the latest compilation of patterns for identified viruses. It is guaranteed to have passed a series of critical tests to ensure that you get optimum protection from the latest virus threats. This pattern file is most effective when used with the latest scan engine.
payload	Payload refers to an action that a virus performs on the infected computer. This can be something relatively harmless, such as displaying messages or ejecting the CD drive, or something destructive, such as deleting the entire hard drive.

TERM	EXPLANATION
policies	Policies provide the initial protection mechanism for the firewall, allowing you to determine what traffic passes across it based on IP session details. They protect the Trusted network from outsider attacks, such as the scanning of Trusted servers. Policies create an environment in which you set up security policies to monitor traffic attempting to cross your firewall.
port	A logical channel or channel endpoint in a communications system, used to distinguish between different logical channels on the same network interface on the same computer. Each application program has a unique port number associated with it.
protected network	A network protected by IWSVA (Trend Micro™ InterScan™ Web Security Virtual Appliance).
proxy	A process providing a cache of items available on other servers which are presumably slower or more expensive to access.
proxy server	A World Wide Web server which accepts URLs with a special prefix, used to fetch documents from either a local cache or a remote server, then returns the URL to the requester.
public-key encryption	An encryption scheme where each person gets a pair of "keys," called the public key and the private key. Each person's public key is published while the private key is kept secret. Messages are encrypted using the intended recipient's public key and can only be decrypted using his or her private key. <i>Also see authentication and digital signature.</i>
purge	To delete all, as in getting rid of old entries in the logs.

TERM	EXPLANATION
quarantine	To place infected data such as email messages, infected attachments, infected HTTP downloads, or infected FTP files in an isolated directory (the Quarantine Directory) on your server.
queue	A data structure used to sequence multiple demands for a resource when mail is being received faster than it can be processed. Messages are added at the end of the queue, and are taken from the beginning of the queue, using a FIFO (first-in, first-out) approach.
recipient	The person or entity to whom an email message is addressed.
registration	The process of identifying yourself as a Trend Micro customer, using a product Registration Key, on the Trend Micro Online Registration screen. <i><a href="https://olr.trendmicro.com/registration">https://olr.trendmicro.com/registration</a></i>
Registration Key	A 22-character code, including hyphens, that is used to register in the Trend Micro customer database. Here is an example of a Registration Key: SM-27RT-UY4Z-39HB-MNW8 <i>Also see Activation Code</i>
relay	To convey by means of passing through various other points.
remote access tool (RAT)	Hardware and software that allow a legitimate system administrator to manage a network remotely. However, these same tools can also be used by intruders to attempt a breach of your system security.
removable drive	A removable hardware component or peripheral device of a computer, such as a zip drive.
replicate	To self-reproduce. As used in this documentation, the term refers to viruses or worms that can self-reproduce.

TERM	EXPLANATION
router	This hardware device routes data from a local area network (LAN) to a phone line's long distance line. Routers also act as traffic cops, allowing only authorized machines to transmit data into the local network so that private information can remain secure. In addition to supporting these dial-in and leased connections, routers also handle errors, keep network usage statistics, and handle security issues.
scan	To examine items in a file in sequence to find those that meet a particular criteria.
scan engine	The module that performs antivirus scanning and detection in the host product to which it is integrated.
script	A set of programming commands that, after invoked, can be executed together. Other terms used synonymously with "script" are "macro" or "batch file."
seat	A license for one person to use a Trend Micro product.
sector	A physical portion of a disk. (Also see partition, which is a logical portion of a disk.)
Secure Socket Layer (SSL)	Secure Socket Layer (SSL), is a protocol designed by Netscape for providing data security layered between application protocols (such as HTTP, Telnet, or FTP) and TCP/IP. This security protocol provides data encryption, server authentication, message integrity, and optional client authentication for a TCP/IP connection.



TERM	EXPLANATION
server	A program which provides some service to other (client) programs. The connection between client and server is normally by means of message passing, often over a network, and uses some protocol to encode the client's requests and the server's responses. The server might run continuously (as a daemon), waiting for requests to arrive, or it might be invoked by some higher-level daemon which controls a number of specific servers.
shared drive	A computer peripheral device that is used by more than one person, thus increasing the risk of exposure to viruses.
signature	See virus signature.
signature-based spam detection	A method of determining whether an email message is spam by comparing the message contents to entries in a spam database. An exact match must be found for the message to be identified as spam. Signature-based spam detection has a nearly zero false positive rate, but does not detect "new" spam that isn't an exact match for text in the spam signature file. <i>Also see rule-based spam detection.</i> <i>Also see false positive.</i>
single device	A machine that is not deployed in any Cluster
SMTP	Simple Mail Transfer Protocol—A protocol used to transfer electronic mail between computers, usually over Ethernet. It is a server-to-server protocol, so other protocols are used to access the messages.
SMTP server	A server that relays email messages to their destinations.

TERM	EXPLANATION
SNMP	Simple Network Management Protocol—A protocol that supports monitoring of devices attached to a network for conditions that merit administrative attention.
SNMP trap	A trap is a programming mechanism that handles errors or other problems in a computer program. An SNMP trap handles errors related to network device monitoring. See SNMP.
spam	Unsolicited email messages meant to promote a product or service.
spyware	Advertising-supported software that typically installs tracking software on your system, capable of sending information about you to another party. The danger is that users cannot control what data is being collected, or how it is used.
subnet mask	<p>In larger networks, the subnet mask lets you define subnetworks. For example, if you have a class B network, a subnet mask of 255.255.255.0 specifies that the first two portions of the decimal dot format are the network number, while the third portion is a subnet number. The fourth portion is the host number. If you do not want to have a subnet on a class B network, you would use a subnet mask of 255.255.0.0.</p> <p>A network can be subnetted into one or more physical networks which form a subset of the main network. The subnet mask is the part of the IP address which is used to represent a subnetwork within a network. Using subnet masks allows you to use network address space which is normally unavailable and ensures that network traffic does not get sent to the whole network unless intended. Subnet masks are a complex feature, so great care should be taken when using them. <i>Also see IP address.</i></p>

TERM	EXPLANATION
switchover	Switchover means IWSVA changes the parent role in the cluster. It can be triggered by user manually, or when system detects a failure.
target (Also see action and notification)	The scope of activity to be monitored for a violating event, such as a virus being detected in an email message. For example, you could target virus scanning of all files passing into and out of your network, or just files with a certain file name extension.
TCP	Transmission Control Protocol—TCP is a networking protocol, most commonly use in combination with IP (Internet Protocol), to govern connection of computer systems to the Internet.
Telnet	The Internet standard protocol for remote login that runs on top of TCP/IP (Transmission Control Protocol/Internet Protocol). This term can also refer to networking software that acts as a terminal emulator for a remote login session.
top-level domain	The last and most significant component of an Internet fully qualified domain name, the part after the last “.”. For example, host <i>wombat.doc.ic.ac.uk</i> is in top-level domain “uk” (for United Kingdom).
Total Solution CD/DVD	A CD or DVD containing the latest product versions and all the patches that have been applied during the previous quarter. The Total Solution CD or DVD is available to all Trend Micro Premium Support customers.
traffic	Data flowing between the Internet and your network, both incoming and outgoing.
Transmission Control Protocol/Internet Protocol (TCP/IP)	A communications protocol which allows computers with different operating systems to communicate with each other. Controls how data is transferred between computers on the Internet.

TERM	EXPLANATION
trigger	An event that causes an action to take place. For example, your Trend Micro product detects a virus in an email message. This might <i>trigger</i> the message to be placed in quarantine, and a notification to be sent to the system administrator, message sender, and message recipient.
Trojan Horse	A malicious program that is disguised as something benign. A Trojan is an executable program that does not replicate, but instead, resides on a system to perform malicious acts, such as opening a port for an intruder.
true-file type	Used by IntelliScan, a virus scanning technology, to identify the type of information in a file by examining the file headers, regardless of the file name extension (which could be misleading).
trusted domain	A domain from which your Trend Micro product will always accept messages, without considering whether the message is spam. For example, a company called Dominion, Inc. has a subsidiary called Dominion-Japan, Inc. Messages from dominion-japan.com are always accepted into the dominion.com network, without checking for spam, because the messages are from a known and trusted source.
trusted host	A server that is allowed to relay mail through your network because they are trusted to act appropriately and not, for example, relay spam through your network.

TERM	EXPLANATION
tunnel interface	A tunnel interface is the opening, or doorway, through which traffic to or from a VPN tunnel passes. A tunnel interface can be numbered (that is, assigned an IP address) or unnumbered. A numbered tunnel interface can be in either a tunnel zone or security zone. An unnumbered tunnel interface can only be in a security zone that contains at least one security zone interface. The unnumbered tunnel interface borrows the IP address from the security zone interface. <i>Also see Virtual Private Network (VPN).</i>
tunnel zone	A tunnel zone is a logical segment that hosts one or more tunnel interfaces. A tunnel zone is associated with a security zone that acts as its carrier.

TERM	EXPLANATION
tunneling	<p>A method of sending data that enables one network to send data through another network's connections. Tunnelling is used to get data between administrative domains which use a protocol that is not supported by the internet connecting those domains.</p> <p>With VPN tunneling, a mobile professional dials into a local Internet Service Provider's Point of Presence (POP) instead of dialing directly into their corporate network. This means that no matter where mobile professionals are located, they can dial a local Internet Service Provider that supports VPN tunneling technology and gain access to their corporate network, incurring only the cost of a local telephone call.</p> <p>When remote users dial into their corporate network using an Internet Service Provider that supports VPN tunneling, the remote user as well as the organization knows that it is a secure connection. All remote dial-in users are authenticated by an authenticating server at the Internet Service Provider's site and then again by another authenticating server on the corporate network. This means that only authorized remote users can access their corporate network, and can access only the hosts that they are authorized to use.</p>
URL	<p>Universal Resource Locator—A standard way of specifying the location of an object, typically a Web page, on the Internet, for example, <i>www.trendmicro.com</i>. The URL maps to an IP address using DNS.</p>

TERM	EXPLANATION
VBscript virus	<p>VBscript (Microsoft Visual Basic scripting language) is a simple programming language that allows Web developers to add interactive functionality to HTML pages displayed in a browser. For example, developers might use VBscript to add a "Click Here for More Information" button on a Web page.</p> <p>A VBscript virus is a virus that is targeted at these scripts in the HTML code. This enables the virus to reside in Web pages and download to a user's desktop through the user's browser.</p> <p><i>Also see JavaScript virus.</i></p>
virtual IP address (VIP address)	<p>A VIP address maps traffic received at one IP address to another address based on the destination port number in the packet header.</p>
Virtual Local Area Network (VLAN)	<p>A logical (rather than physical) grouping of devices that constitute a single broadcast domain. VLAN members are not identified by their location on a physical subnetwork but through the use of tags in the frame headers of their transmitted data. VLANs are described in the IEEE 802.1Q standard.</p>
Virtual Private Network (VPN)	<p>A VPN is an easy, cost-effective and secure way for corporations to provide telecommuters and mobile professionals local dial-up access to their corporate network or to another Internet Service Provider (ISP). Secure private connections over the Internet are more cost-effective than dedicated private lines. VPNs are possible because of technologies and standards such as tunneling and encryption.</p>
virtual router	<p>A virtual router is the component of Screen OS that performs routing functions. By default, Trend Micro GateLock supports two virtual routers: Untrust-VR and Trust-VR.</p>

<b>TERM</b>	<b>EXPLANATION</b>
virtual system	<p>A virtual system is a subdivision of the main system that appears to the user to be a stand-alone entity. Virtual systems reside separately from each other in the same Trend Micro GateLock remote appliance; each one can be managed by its own virtual system administrator.</p>
virus	<p>A computer virus is a program – a piece of executable code – that has the unique ability to infect. Like biological viruses, computer viruses can spread quickly and are often difficult to eradicate.</p> <p>In addition to replication, some computer viruses share another commonality: a damage routine that delivers the virus payload. While payloads might only display messages or images, they can also destroy files, reformat your hard drive, or cause other damage. Even if the virus does not contain a damage routine, it can cause trouble by consuming storage space and memory, and degrading the overall performance of your computer.</p>
virus kit	<p>A template of source code for building and executing a virus, available from the Internet.</p>
virus signature	<p>A virus signature is a unique string of bits that identifies a specific virus. Virus signatures are stored in the Trend Micro virus pattern file. The Trend Micro scan engine compares code in files, such as the body of an email message, or the content of an HTTP download, to the signatures in the pattern file. If a match is found, the virus is detected, and is acted upon (for example, cleaned, deleted, or quarantined) according to your security policy.</p>
virus trap	<p>Software that helps you capture a sample of virus code for analysis.</p>
virus writer	<p>Another name for a computer hacker, someone who writes virus code.</p>



TERM	EXPLANATION
Web	The World Wide Web, also called the Web or the Internet.
Web console	The user interface for your Trend Micro product.
Web server	A server process running at a Web site which sends out Web pages in response to HTTP requests from remote browsers.
wildcard	A term used in reference to content filtering, where an asterisk (*) represents any characters. For example, in the expression *ber, this expression can represent barber, number, plumber, timber, and so on. The term originates from card games, in which a specific card, identified as a "wildcard," can be used for any number or suit in the card deck.
working directory	The destination directory in which the main application files are stored, such as /etc/iscan/IWSVA.
workstation (also known as client)	A general-purpose computer designed to be used by one person at a time and which offers higher performance than normally found in a personal computer, especially with respect to graphics, processing power and the ability to carry out several tasks at the same time.
worm	A self-contained program (or set of programs) that is able to spread functional copies of itself or its segments to other computer systems.
zip file	A compressed archive (in other words, "zip file") from one or more files using an archiving program such as WinZip.
zone	A zone can be a segment of network space to which security measures are applied (a security zone), a logical segment to which a VPN tunnel interface is bound (a tunnel zone), or a physical or logical entity that performs a specific function (a function zone).



---

## A

- AC 14-30
- access control
  - by client IP 6-13
  - FTP 11-13
  - identifying clients/servers 6-13
  - management 14-23
  - settings 6-12, 15-20
  - setup 14-20
- access quota policies 15-19
- access quotas 9-1
  - adding 9-2
  - deactivating a policy 9-3
  - deleting a policy 9-4
  - exceeding during a download 9-2
  - introducing 9-2
  - managing 9-2
- access rights 7-21
- access warning
  - Time-to-Live (TTL) 10-13
- accounts
  - add 7-20
  - administration 14-22
  - change 7-21
  - login 14-22
- actions
  - infected file (FTP) 11-10
  - Macro Scan (FTP) 11-11
  - password-protected file (FTP) 11-11
  - uncleanable file (FTP) 11-11
- activation code 14-30
- active FTP 11-3
- active/passive pairs 3-3
- ActiveUpdate 4-3
  - incremental updates 4-10
  - without Control Manager 4-3
- ActiveX objects
  - security rules 8-85
  - signature verification 8-76, 8-88

- additional risks
  - defined 8-64
- administration
  - accounts 14-22
  - menu
    - overview 14-2
- anonymous FTP 6-11
- anti-virus scan engine 4-5
- Applets and ActiveX security 1-24
  - adding/modifying policies 8-79
  - digital certificates 8-90
  - enabling 8-78
  - how it works 8-75—8-76
  - notifications 8-89, 13-25
  - re-signing 8-87
  - thread groups 8-84
- Application Control 1-2
  - add policies 5-4
  - edit policies 5-5
  - overview 5-2
  - policy list 5-2
  - settings 5-8
  - specify rules 5-6
  - testing 15-8
  - view policies 5-4
- Application Health Monitor 3-5
- application patch
  - adding 15-21
  - removing 15-21
- Application Traffic Statistics 1-2
- approved URL
  - list format 8-71
- API blocking
  - reports 13-4
- audit log 14-3

## B

- backup/restore 14-24
- bandwidth
  - reports 13-4

- best practices
  - scan engine E-4
  - scanning considerations E-2
  - suggestions E-3
- Blue Coat appliance
  - setting up 2-45
- botnet detection 8-43
  - reports 13-4
- Bots A-16
- C**
- C&C callback attempt detection 8-43
- C&C contact alert counts
  - reports 13-4
- C&C contact alerts 1-22
- C&C contact detection 8-42–8-43
  - notifications 13-25
  - rules 8-68
- cache
  - appliance
    - flushing 2-51
  - content 2-50
  - flushing 2-51
  - policy settings 15-22
- Central Management
  - for High Availability 3-6
  - managed vs. non-managed features 3-7
  - synchronization 3-6
- certificates
  - activating 8-92
  - adding 8-92
  - authority 8-37
    - export 8-39
  - deleting 8-92
  - flagging 8-93
  - import 8-38
  - removing flag 8-93
  - viewing 8-91
- changing the weight value of a node 3-20
- Cisco CE ICAP server 2-48
- CLI commands 12-3
  - remote 14-19
- client certificate handling 8-37
- client IP to user ID cache 15-26
- cloud-based services E-3
- cluster
  - accessing the child node 3-12
  - accessing the parent node 3-12
  - configuration 2-50, 3-10
  - creating a new cluster 2-6
  - IP address 2-6
  - joining an existing 2-8
  - logs 3-12
  - management
    - cluster IP address 2-5
    - cluster logs 3-12
  - member settings 3-18
  - settings 3-17
- cluster management 3-1, 3-10
  - changing the weight value of a node 3-20
  - cluster configuration 3-10
  - cluster member settings 3-18
  - cluster settings 3-17
  - deleting a cluster 3-15
  - dissolving a cluster 3-15
  - modifying a cluster 3-17
  - node configuration 3-11
  - Web console page 3-15
  - Weighted Priority Election 2-6
- command list 12-3
- Command-and-Control Contact Alert - see C&C contact alerts 1-22
- compressed files 11-9
  - security settings 8-58
- concurrent connections display 1-15
- configuration 15-1
  - backup/restore 14-24
  - files C-1, C-4

- 
- Content Cache 1-11
    - clearing 8-48
    - exceptions list 8-51
    - managing 8-49
    - real-time statistics 8-50
    - using 8-47
  - Control Manager
    - register to 14-15
  - controlled pattern releases (CPRs) 4-14
    - incremental updates 4-14
    - installing 4-14
  - CPU Usage Display 1-18
  - custom categories 10-9
  - custom defense
    - settings 8-43
  - cyrus-sasl-2.1.19 D-2
  - D**
  - Dashboard 2-39
  - data interface 2-29
  - data security
    - reports 13-5
  - database
    - connection 14-11
    - connection settings 15-22
    - testing connection 15-22
  - database connection
    - testing 15-22
  - delete 13-9
    - cluster 3-15
  - deleting a cluster 3-15
  - dependent mode 6-5
  - deployment 2-2
    - Deployment Wizard 2-2
  - Deployment Wizard 2-1
    - data interface 2-29
    - flow 2-2
    - forward proxy mode 2-9, 2-16
    - ICAP mode 2-11
    - ICAP Settings 2-19
    - mode selection 2-2
    - mode-specific settings 2-15
    - overview 2-2
    - proxy settings 2-16
    - reverse proxy mode 2-10
    - reverse proxy settings 2-18
    - simple transparency mode 2-13
    - standalone proxy mode settings 2-16
    - transparent bridge mode 2-3
    - upstream proxy (dependent) mode settings 2-17
    - Web Cache Coordination Protocol (WCCP) Mode 2-14
  - destination ports (FTP) 11-15
  - digital certificates
    - managing 8-90
  - directory (LDAP) server
    - performance 15-26
  - dissolving a cluster 3-15
  - documentation set 0-xxii
  - download scanning
    - testing 15-12
  - E**
  - EICAR test file 15-2, A-6
  - enable\_ip\_user\_cache 15-26
  - ESMTP 13-17
  - exception lists
    - creating 8-70
    - file name 8-68
    - URL 8-68
  - expiration warning 14-28
  - F**
  - failover vs. switchover 3-4
  - false alarm 4-13
  - file name
    - list format 8-72
  - file types 8-53–8-54

- blocking 8-52–8-53
  - specifying (FTP) 11-6
- flagged certificates 8-80
- flushing the cache 2-50
- forced updates 4-13
- forward proxy mode 2-9, 2-16
- FTP
  - anonymous 6-11
  - port restrictions 11-15
  - turning on/off the service 11-4
- FTP access control settings 11-13
  - approved server IP 11-14
  - by client IP 11-13
  - by destination port 11-15
- FTP Blocked File Type notifications 13-28
- FTP over HTTP 6-7, 8-63
- FTP proxy 11-3
- FTP scanning 1-8
  - active 11-3
  - approved server IP list 11-14
  - compressed files 11-7, 11-9
  - configuring 11-6
  - enabling 11-5
  - enabling traffic 11-5
  - exception list 11-8
  - file blocking 11-6
  - files to scan 11-6
  - introduction 11-2
  - large files 11-7
  - notifications 13-29
  - options 11-4
  - passive 11-3
  - priority 11-6
  - proxy settings 11-3
  - quarantine 11-8
  - scan actions on viruses 11-10
  - scan direction 11-6
  - settings 11-2, 11-4, 11-8

- spyware/grayware 11-8
- testing 15-7

## G

- Global Policy 7-4
- glossary A-6, A-1
- grayware
  - defined 8-64
- groups
  - reports 13-3
- guest
  - accounts 15-19
  - policies 7-4
    - about 7-5
  - ports
    - enabling 7-5

## H

- hard drive display 1-19
- hardware status 1-16
- heimdal-0.6.2 D-2
- High Availability 2-4, 3-1
  - active/passive pairs 3-3
- Agent
  - Application Health Monitor 3-5
  - Central Management 3-6
  - failover vs. switchover 3-4
  - interface 2-7
  - interface status 2-27
  - link loss detection 3-6
  - overview 3-2
  - parent/child pairs 3-3
  - synchronization 3-6
- honeynets 8-43
- hot fixes 15-21
- HTTP
  - enabling/disabling traffic 6-2
  - file types to block 8-52
  - file types to scan 8-53
  - port restrictions 6-15

- 
- security threats 1-22
  - service, turning on/off 6-2
  - HTTP Inspection 1-2
    - add policies 8-5
    - exceptions 8-8
    - filters 8-8
      - filters, add 8-13
      - filters, advanced view 8-19
      - filters, basic view 8-13
      - filters, default 8-8, 8-11
      - filters, edit 8-22
      - filters, export 8-25
      - filters, import 8-23
      - filters, method values 8-16
      - filters, packet capture 8-14
      - filters, PCRE flags 8-18
    - overview 8-3
    - policies 8-4
    - specify rules 8-6
    - testing 15-10
  - HTTP scanning
    - compressed files 8-57
    - creating/modifying policies 8-40
    - deferred scanning 8-61–8-62
    - enabling/disabling 8-2
    - file blocking 8-52
    - files to scan 8-53
    - intranet sites 9-6
    - large files 8-58
    - notifications 13-30
    - performance 8-2
    - priority 8-57
    - progress page 8-60
    - quarantine 8-64
    - rules 8-52
    - scan actions 8-72
    - scan before delivering 8-59, 8-62
    - scan events 8-73
    - security settings 8-58
    - settings 6-1
    - skipping files 8-2
    - specifying 15-18
    - trusted URLs 9-6
  - HTTPS
    - accelerator card support 8-32
    - access denied
      - notification 13-31
    - certificate failure notifications 13-32
    - encryption policies 8-32
    - port restrictions 6-16
    - scanning 6-11
    - security 1-6
  - HTTPS decryption 1-6, 8-29
    - policy
      - create 8-34
    - process flow 8-31
    - scanning
      - testing 15-3
    - settings 8-36
- I**
- ICAP
    - requests
      - listening 2-51
    - settings 2-19
  - ICAP mode 2-11
    - Bypass on Failure 2-44
    - cache servers 2-43
    - license key 2-44
    - multiple servers 2-45
    - post-install tasks 2-43
    - request 2-51
    - respond 2-51
  - ICSA certification 4-9
  - incremental pattern file updates 4-10
  - installation
    - Blue Coat appliance 2-45, 2-48
    - NetCache appliance 2-43

- instrumentation 8-77
- IntelliScan 8-53
- IntelliTrap
  - exception pattern files 4-7
  - pattern files 4-7
- interface status 2-27
  - icons definitions 2-28
  - interface mapping 2-29
- Internet access
  - reports 13-4
- Internet security
  - reports 13-3
- ip\_user\_central\_cache\_interval 15-26
- IWSVA
  - components C-2
  - configuration 14-3, 15-1
  - features 1-2
  - main features 1-2
  - modules C-2
  - services C-2
  - testing 15-1, 15-24

## J

- Java Applet and ActiveX Scanning
  - testing 15-14
- Java applets
  - instrumentation settings 8-81
  - instrumenting 8-77
  - real-time monitoring 8-78
  - security rules 8-79
  - signature status 8-80
  - signature validation 8-86
  - signature verification 8-76
- Java runtime 2-46

## K

- Kerberos D-1
- Knowledge Base 0-xxii
  - URL 0-xxii, A-4

## L

- large file handling
  - deferred scanning 8-62
  - HTTP 6-12, 8-58
  - important notes 8-63
- LDAP
  - AD Global Catalog 7-17
  - attribute names 7-14
  - authentication 7-10
  - communication flows 7-11
  - configuring 7-13
  - Internal Caches 15-26
  - performance tuning 15-26
  - supported directories 7-10
  - testing connection 7-16
- ldapsearch D-8
- license
  - expiration warning 14-28
  - product 14-27
  - update 14-30
- link loss detection 3-6
- listening port 6-10, 15-24
- log files
  - naming conventions 13-14
- log settings 13-13
- login
  - accounts 7-20
- logs 1-9
  - cluster logs 3-12
  - configure syslog server 13-15
  - exporting as CSV files 13-14
  - exporting as PDF files 13-15
  - introduction 13-9
  - MAC address client identification 13-42
  - querying/viewing 13-13
  - settings 13-13
  - system event 14-27
- lpt\$vpn.xyz 4-13



---

## M

- MAC address client identification
  - notifications 13-42
- macro scanning 8-74
  - actions 8-73
- maintenance agreement
  - renewing 4-2, 14-30
- malware scanning 1-6
- management console 14-22
  - password 15-23
- manual switchover
  - performing 3-16
- MIME-type 8-2, 8-55, B-1
- mixed threats 1-22
- mode-specific settings 2-15
- modifying a cluster 3-17
- multiple installs 1-11

## N

- NetCache appliance
  - setting up 2-43
- network configuration 14-18
- node configuration 3-11
- notifications 1-9, 11-10
  - administrator vs. user 13-16
  - applets and ActiveX 13-25
  - C&C contact detection 13-25
  - configuring 13-24
  - email settings 13-17
  - enabling for scan engine updates 13-39
  - enabling for URL filtering engine 13-39
  - ESMTP support 13-17
  - FTP blocked file type 13-28
  - FTP scanning 13-29
  - HTTP/HTTPS file blocking 13-29
  - HTTP/HTTPS scanning 13-30
  - HTTPS access denied 13-31
  - HTTPS certificate failure 13-32
  - introduction 13-16

- MAC address client identification 13-42
  - parameters 13-17
  - pattern file updates 13-33
  - scan engine updates 13-38–13-39
  - SNMP trap 13-40
  - threshold alerts 1-15
  - tokens 13-17
  - URL access override 13-36
  - URL access warning 13-34
  - URL blocking by access control 13-37
  - URL blocking by HTTP Inspection 13-38
  - URL blocking by URL filtering 13-39
  - URL filtering 13-38–13-39
  - URL Filtering by Time Quota 13-40
  - using HTML tags 13-24
  - using variables in 13-17
  - variables 13-18

## O

- online help 0-xxiii
- OpenLDAP D-1
  - sample ldap.conf D-2
  - sample slapd.com D-3
  - software compatibility D-2
- openldap-2.2.17 D-2
- openssl-0.9.7d D-2

## P

- page analysis pattern 4-7
- parent/child pairs 3-3
- passive FTP 11-3
- password 15-23
  - tips for creating 15-23
- patches 4-2, 15-21
  - application 14-25
  - OS 14-25
- pattern files 4-5
  - deleting 4-13

- manually deleting 4-14
- matching 4-6
- several on server 4-6
- spyware/grayware 4-7
- version numbering 4-6–4-7

payload 1-21

performance tuning 15-25

- LDAP 15-26

Phish 4-7

physical memory usage display 1-19

policies

- adding notes 8-74
- configuring the scope 7-17
- default 7-4
- deployment 14-11
- exceptions
  - ActiveX 8-85
  - applet 8-85
- how they work 7-2
- practical examples 7-2
- request mode 2-47
- response mode 2-47

policy enforcement

- reports 13-5

product

- license 14-27
- maintenance A-5

progress page 8-59

protocol handlers C-6

proxy

- caching 6-5
- configuring 6-2, 6-5
- listening port 6-10
- reverse 1-11, 6-9
- settings 2-16, 4-4, 6-10
- stand-alone mode 6-4
- upstream proxy (dependent mode) 6-5

## Q

quarantine

- directory 14-12
- files
  - encrypting 11-8, 14-12
- management 14-12

## R

readme 0-xxiii, 4-2

RealAudio 8-55

receive greeting 11-10

register\_user\_agent\_header.exe 7-9

registration

- IWSVA 14-28
- key 14-29
- profile 4-2
- URL 4-2

remote CLI 14-19

reports 1-9

- additional settings 13-3
- APT blocking 13-4
- availability 13-6
- bandwidth 13-4
- botnet detection 13-4
- C&C contact alert counts 13-4
- concurrent connections display 1-15
- CPU usage display 1-18
- customizing 13-9
- data security 13-5
- deleting scheduled 13-9
- groups 13-3
- hard drive display 1-19
- hardware status 1-16
- Internet access 13-4
- Internet security 13-3
- introduction 13-2
- MAC address client identification 13-42
- physical memory usage display 1-19
- policy enforcement 13-5

---

real-time 13-5  
scheduled 13-8  
settings 13-2–13-3  
types 13-2–13-3, 13-7  
users 13-3

REQMOD 6-15

re-signing  
  applet 8-87

RESPMOD 6-15

restore 14-24

reverse proxy 6-9  
  configuring 6-9  
  DNS changes 6-10  
  mode 2-10  
  mode settings 2-18

risk ratings A-6

rollback 4-13

root certificates 8-86

**S**

Safe Search 10-8

scan engine 4-8, E-4  
  events that trigger an update 4-9  
  ICSA certification 4-9  
  updates to 4-9  
  updating 4-8  
  URL to find current version 4-9

scan engine update notifications 13-38–13-39

scanning  
  considerations E-2  
  modules C-6  
  rules  
    spyware/grayware 8-64  
  select file types 8-54

scheduled reports 13-8

scheduled tasks C-3

Security Information Center 15-25, A-5–A-6

security patches 15-21

server certificate validation 8-36

server clusters 2-49  
  deleting 2-50

server IP white list  
  adding servers 6-15  
  ICAP mode 6-15

ServerIPWhiteList.ini 6-14

service packs 15-21

settings  
  custom defense 8-43  
  reports 13-2

signature status  
  revocation status 8-87  
  untrusted 8-87

signature verification  
  applet 8-86

simple transparency mode 2-13

slapadd D-7

slapcat D-7

slapd.conf D-3

slapindex D-8

slaptest D-8

Smart Protection Network E-3–E-5

Smart Search 1-24

SNMP 1-9  
  queries 1-17  
  settings 14-20  
  trap notifications 13-40  
  traps 1-17

SolutionBank-see Knowledge Base 0-xxii

spyware scanning  
  testing 15-13

spyware/grayware  
  pattern file 4-7  
  scanning rules 8-64

SSH access 12-2

SSL handshake  
  overview 8-30

standalone proxy mode settings 2-16

static routes 14-21

- support 14-31
- suspicious files A-3
- syslog 1-10
- syslog server
  - configure 13-15
- system
  - event 14-27
  - information setup 14-20
  - maintenance 14-26
  - time 14-13
  - updates 14-25

## T

- technical support
  - contacting A-2
- testing 15-1
  - ActiveX scanning 15-14
  - Application Control 15-8
  - database connection 15-22
  - download scanning 15-12
  - FTP scanning 15-7
  - HTTP Inspection 15-10
  - HTTPS decryption scanning 15-3
  - Java Applet scanning 15-14
  - spyware scanning 15-13
  - upload scanning 15-3
  - URL filtering 15-11, 15-13
  - URL monitoring 15-11
  - Web Reputation 15-2
- threshold alert notification 1-15
- time zone 14-13
- time-to-live (TTL) 9-2
- tokens in notifications 13-17
- transparency 6-7
- Transparent Bridge Mode 2-3
  - High Availability 2-4
- transparent identification
  - topology E-6
- Trend Micro

- contact information A-2
- TrendLabs A-4
- true file type 8-53
- trusted URLs 9-6
  - importing 9-6
  - managing 9-7
- TTL 9-2

## U

- updates 4-10
  - application patches 14-25
  - components 4-5, 4-10
  - disabling scheduled updates 4-12
  - forced 4-11
  - incremental 4-10
  - manual 4-10
  - notifications 4-13, 13-33
  - proxy settings 4-4
  - recommendations 4-3
  - rolling back 4-13
  - scan engine 4-8
  - scheduled 4-3, 4-12
  - system 14-25
- upload scanning
  - testing 15-3
- upstream proxy (dependent) mode settings 2-17
- URL access
  - override
    - notifications 13-36
  - overview 9-4
  - specifying 9-5
  - warning 10-13
  - warning notifications 13-34
- URL blocking 9-8
  - by access control notifications 13-37, 13-39
  - by HTTP Inspection notifications 13-38
  - by URL filtering notifications 13-39
  - importing 9-9
  - importing a list 9-10

- 
- local List 9-8
  - wildcards 9-10
  - URL blocking by access control notifications 13-37
  - URL cache
    - clear 8-46
  - URL filtering 1-8, 4-9, 15-24
    - actions 10-3
    - by Time Quota notification 13-40
    - categories H-1
    - creating a policy 10-6
    - custom categories 10-9
    - customizing 10-2
    - database 4-9
    - enabling 10-5
    - exceptions 10-12—10-13
    - managing categories 10-11
    - managing policies 10-5
    - notifications 13-38—13-39
    - overview 10-2
    - password override action 1-2, 10-3
    - policy, introduction 10-5
    - re-classification 10-11
    - reviewing settings 15-24
    - Safe Search 10-8
    - schedule 10-13
    - settings 10-9
    - testing 15-13
    - time limit action 1-3, 10-4
    - time quota extension 1-3, 10-14
    - time settings 10-12
    - workflow 10-4
  - URL lookup 10-11
  - URL monitoring
    - testing 15-11
  - URL reclassification 10-11
  - URLs
    - Knowledge Base 0-xxii, A-2—A-3
    - registration 4-2
    - scan engine version 4-9
    - Security Information Center A-5
  - user authentication cache 15-26
  - user group membership cache 15-26
  - user identification method 1-8, 7-1
    - Client Registration Utility 7-9
    - configuring 7-6, 15-19
    - host name 7-9
    - IP address 7-8, 7-18
    - types of 7-7
    - user/group name authentication 7-10
  - user/group name authentication (LDAP) 15-19
  - user\_groups\_central\_cache\_interval 15-26
  - users
    - reports 13-3
- V**
- validation 8-36
  - variables
    - using in notifications 13-18
  - verbose logging 15-27
  - virus
    - "in the wild" 4-8
    - "in the zoo" 4-8
    - action 8-72
    - alert service A-6
    - encyclopedia A-5
    - map A-5
    - pattern file, published 4-6
    - primer A-6
    - scan engine 4-5
    - scanning 1-6
      - actions 11-10
      - configuration 6-2
      - scanning server clustered 2-49
  - virus doctors-see TrendLabs A-4
  - virus signatures
    - see virus pattern file
  - Visual Policy Manager 2-46

## W

### WCCP

- change default service F-18
- Cisco 2821 Routers F-3
- Cisco 3750 switches F-6
- Cisco ASA devices F-9
- configuration file F-15
- configure Cisco routers F-21
- enable Cisco event log F-25
- enable event log F-24
- fault tolerance F-20
- introduction F-2
- IWSVA overview F-2
- IWSVA tips F-15
- mode 2-14
  - deployment F-11
- packet debug F-31
- packet flow F-34
- packet redirection F-32
- redundancy F-20
- registration activity F-29
- troubleshooting F-23
- troubleshooting process F-25
- verify IWSVA configuration F-26

### web

- console 14-19
- threat
  - information 1-19

### Web Cache Coordination Protocol (WCCP) Mode 2-14

### Web Reputation

- feedback option 8-45
- managing results 8-45
- settings 8-44
- specifying rules 8-42
- testing 15-2

### weekly virus report A-5

### Weight

- settings 2-7

### Weighted Priority Election 2-6

- settings 2-6–2-7

### what's new 1-12

### white papers A-6

### wildcards 9-10

### WRS cache

- clear 8-46

## X

### X-Forwarded-For header 1-11

### X-Forwarded-For HTTP headers 8-65

- actions available 8-66

- configuring 8-67

- deployment scenarios 8-66